

FLUKE®

— **Hart Scientific**®

9210

*Triple Point of Water
Maintenance Apparatus
User's Guide*

Limited Warranty & Limitation of Liability

Each product from Fluke Corporation, Hart Scientific Division ("Hart") is warranted to be free from defects in material and workmanship under normal use and service. The warranty period is one year for the Triple Point of Water Maintenance Apparatus. The warranty period begins on the date of the shipment. Parts, product repairs, and services are warranted for 90 days. The warranty extends only to the original buyer or end-user customer of a Hart authorized reseller, and does not apply to fuses, disposable batteries or to any other product, which in Hart's opinion, has been misused, altered, neglected, or damaged by accident or abnormal conditions of operation or handling. Hart warrants that software will operate substantially in accordance with its functional specifications for 90 days and that it has been properly recorded on non-defective media. Hart does not warrant that software will be error free or operate without interruption. Hart does not warrant calibrations on the Triple Point of Water Maintenance Apparatus.

Hart authorized resellers shall extend this warranty on new and unused products to end-user customers only but have no authority to extend a greater or different warranty on behalf of Hart. Warranty support is available if product is purchased through a Hart authorized sales outlet or Buyer has paid the applicable international price. Hart reserves the right to invoice Buyer for importation costs of repairs/replacement parts when product purchased in one country is submitted for repair in another country.

Hart's warranty obligation is limited, at Hart's option, to refund of the purchase price, free of charge repair, or replacement of a defective product which is returned to a Hart authorized service center within the warranty period.

To obtain warranty service, contact your nearest Hart authorized service center or send the product, with a description of the difficulty, postage, and insurance prepaid (FOB Destination), to the nearest Hart authorized service center. Hart assumes no risk for damage in transit. Following warranty repair, the product will be returned to Buyer, transportation prepaid (FOB Destination). If Hart determines that the failure was caused by misuse, alteration, accident or abnormal condition or operation or handling, Hart will provide an estimate or repair costs and obtain authorization before commencing the work. Following repair, the product will be returned to the Buyer transportation prepaid and the Buyer will be billed for the repair and return transportation charges (FOB Shipping Point).

THIS WARRANTY IS BUYER'S SOLE AND EXCLUSIVE REMEDY AND IS IN LIEU OF ALL OTHER WARRANTIES, EXPRESS OR IMPLIED, INCLUDING BUT NOT LIMITED TO ANY IMPLIED WARRANTY OF MERCHANTABILITY OR FITNESS FOR A PARTICULAR PURPOSE. HART SHALL NOT BE LIABLE FOR ANY SPECIAL, INDIRECT, INCIDENTAL, OR CONSEQUENTIAL DAMAGES OR LOSSES, INCLUDING LOSS OF DATA, WHETHER ARISING FROM BREACH OF WARRANTY OR BASED ON CONTRACT, TORT, RELIANCE OR ANY OTHER THEORY.

Since some countries or states do not allow limitation of the term of an implied warranty, or exclusion or limitation of incidental or consequential damages, the limitations and exclusions of this warranty may not apply to every buyer. If any provision of this Warranty is held invalid or unenforceable by a court of competent jurisdiction, such holding will not affect the validity or enforceability of any other provision.

Fluke Corporation, Hart Scientific Division

799 E. Utah Valley Drive • American Fork, UT 84003-9775 • USA
Phone: +1.801.763.1600 • Telefax: +1.801.763.1010
E-mail: support@hartscientific.com

www.hartscientific.com

Subject to change without notice. • Copyright © 2005 • Printed in USA

Table of Contents

1	Before You Start	1
1.1	Introduction	1
1.2	Symbols Used	2
1.3	Safety Information	3
1.3.1	Warnings	3
1.3.2	Cautions	5
1.4	Authorized Service Centers.	6
2	Specifications and Environmental Conditions	9
2.1	Specifications	9
2.2	Environmental Conditions	9
3	Quick Start	11
3.1	Unpacking	11
3.2	Setup.	11
3.3	Power	12
3.4	Setting the Temperature	12
3.5	Changing Display Units.	12
4	Parts and Controls	13
4.1	Bottom Panel	13
4.2	Front Panel	14
4.3	Top Panel	15
4.4	Rear Panel	16
4.5	Thermal Block Assembly	16
4.5.1	Thermal Block	16
4.5.2	Heaters	16
4.5.3	Triple Point of Water Cell.	16
4.5.4	Cell Pad	18
4.5.5	Top Insulation Plug	18
4.5.6	Control Probe	18
5	Controller Operation.	19
5.1	Well Temperature	19
5.2	Reset Cut-out	19
5.3	Temperature Set-point.	21
5.3.1	Programmable Set-points	21

5.3.2	Set-point Value	22
5.4	Temperature Scale Units	22
5.5	Scan	22
5.5.1	Scan Control	22
5.5.2	Scan Rate	23
5.6	Program Advance	23
5.7	Temperature Scale Units	24
5.8	Secondary Menu.	24
5.9	Heater Power	24
5.10	Set-point Resistance.	24
5.11	Proportional Band	25
5.12	Controller Configuration	26
5.13	Operating Parameters	26
5.13.1	High Limit.	27
5.13.2	Soft Cut-out	27
5.13.3	Cut-out Reset Mode.	27
5.14	Program Parameters	28
5.14.1	Freeze Temperature	28
5.14.2	Freeze Duration	28
5.14.3	Maintain Temperature.	29
5.14.4	Maintain Timeout	29
5.14.5	Maintain Duration	29
5.14.6	Melt Temperature	29
5.14.7	Beeper.	30
5.15	Serial Interface Parameters	30
5.15.1	Baud Rate	30
5.15.2	Sample Period.	31
5.15.3	Duplex Mode	31
5.15.4	Linefeed.	31
5.16	Calibration Parameters	32
5.16.1	R0	32
5.16.2	ALPHA	33
5.16.3	DELTA	33
5.16.4	Triple Point of Water Offset (tPOS)	33

6 Digital Communication Interface 37

6.1	Serial Communications	37
6.1.1	Wiring.	37
6.1.2	Setup	37
6.1.2.1	Baud Rate.	38
6.1.2.2	Sample Period.	38
6.1.2.3	Duplex Mode	38
6.1.2.4	Linefeed.	38
6.1.3	Serial Operation.	38
6.2	Interface Commands	39

7	Triple Point of Water Realization	43
7.1	General	43
7.2	Installing the TPW Cell	44
7.3	Melting the Cell in Preparation for Freezing	45
7.4	Supercooling the Cell	46
7.5	Freezing the Cell	46
7.6	Maintaining the Triple Point	47
7.7	Melting the Cell After Use	48
8	Calibration Procedure	49
8.1	Calibration Equipment	49
8.2	Calibration Procedure	49
9	Maintenance	51
10	Troubleshooting.	53
10.1	Troubleshooting Problems, Possible Causes, and Solutions	53
10.2	CE Comments	54
10.2.1	EMC Directive	54
10.2.2	Low Voltage Directive (Safety)	54

Figures

- Figure 1 Bottom Panel 13
- Figure 2 Front Panel 14
- Figure 3 Top Panel 15
- Figure 4 Rear Panel. 17
- Figure 5 Control Flow Chart 20
- Figure 6 Serial Cable Wiring 37

Tables

Table 1	International Electrical Symbols	2
Table 2	9210 Specifications.	9
Table 3	Communications Command Summary	40
Table 3	Communications Command Summary cont.	41

1 Before You Start

1.1 Introduction

The model 9210 is a specialized instrument for the realization of certain defining fixed-points of the International Temperature Scale of 1990 (ITS-90). This instrument is intended for Calibration Laboratory use and not for field applications. The 9210 permits simplified realization of the triple point of water. Internal programming of the micro-processor controller provides preprogrammed scan rates, set-points for each step in the process, dwell timing, and indication that the next step is ready. The 9210 is available in 100–230 VAC ($\pm 10\%$), 50–60 Hz.

The 9210 may also be used as a dry-well calibrator or as a temperature comparator. Pre-drilled inserts are available from Hart Scientific for this application.

Built in programmable features include:

- Temperature scan rate control
- Fixed-point programming
- Eight set-point memory
- Adjustable readout in °C or °F

The temperature is accurately controlled by Hart's special proportional-integral-derivative (PID)/digital controller. The controller uses a precision, platinum RTD as a sensor and controls the well temperature with thermoelectric peltier devices.















The LED front display panel continuously shows the current well temperature. The temperature may be easily set with the control buttons to any desired temperature within the specified range.



The 9210 was designed for high accuracy calibrations using comparison measurements or fixed-point calibration methods and for ease of operation. Through proper use, the instrument will continuously provide accurate calibration of temperature sensors and devices. The user should be familiar with the safety guidelines and operating procedures of the instrument as described in this user manual.

1.2 Symbols Used

Table 1 lists the International Electrical Symbols. Some or all of these symbols may be used on the instrument or in this manual.

Table 1 *International Electrical Symbols*

Symbol	Description
	AC (Alternating Current)
	AC-DC
	Battery
	CE Complies with European Union Directives
	DC
	Double Insulated
	Electric Shock
	Fuse
	PE Ground
	Hot Surface (Burn Hazard)
	Read the User's Manual (Important Information)
	Off
	On
	Canadian Standards Association

Symbol	Description
CAT II	OVERVOLTAGE (Installation) CATEGORY II, Pollution Degree 2 per IEC1010-1 refers to the level of Impulse Withstand Voltage protection provided. Equipment of OVERVOLTAGE CATEGORY II is energy-consuming equipment to be supplied from the fixed installation. Examples include household, office, and laboratory appliances.
	C-TIC Australian EMC Mark
	The European Waste Electrical and Electronic Equipment (WEEE) Directive (2002/96/EC) mark.

1.3 Safety Information

Use this instrument only as specified in this guide. Otherwise, the protection provided by the instrument may be impaired. Refer to the safety information in the Warnings and Cautions sections below.

The following definitions apply to the terms “Warning” and “Caution”.

- “Warning” identifies conditions and actions that may pose hazards to the user.
- “Caution” identifies conditions and actions that may damage the instrument being used.

1.3.1 Warnings

To avoid personal injury, follow these guidelines.

GENERAL

DO NOT use this instrument in environments other than those listed in the User’s Guide.

Inspect the instrument for damage before each use. **DO NOT** use the instrument if it appears damaged or operates abnormally.

Follow all safety guidelines listed in this guide.

Calibration equipment should only be used by trained personnel.

If this equipment is used in a manner not specified by the manufacturer, the protection provided by the equipment may be impaired.

Before initial use, or after transport, or after storage in humid or semi-humid environments, or anytime the dry-well has not been energized for more than 10 days, the instrument needs to be energized for a “dry-out” period of 2 hours before it can be assumed to meet all of the safety requirements of the IEC 1010-1. If the product is wet or has been in a wet environment, take necessary measures to remove moisture prior to applying power such as storage in a low humidity temperature chamber operating at 50°C for 4 hours or more.

DO NOT use this instrument for any application other than calibration work. The instrument was designed for temperature calibration. Any other use of the instrument may cause unknown hazards to the user.

Completely unattended operation is not recommended.

DO NOT place the instrument under a cabinet or other structure. Overhead clearance is required. Always leave enough clearance to allow for safe and easy insertion and removal of probes.

Use of this instrument at **HIGH TEMPERATURES** for extended periods of time requires caution.

Completely unattended high temperature operation is not recommended due to safety hazards that can arise.

If the instrument is used in a manner not in accordance with the equipment design, the operation of the dry-well may be impaired or safety hazards may arise.

This instrument is intended for indoor use only.

BURN HAZARD

DO NOT turn the instrument upside down with the inserts in place; the inserts will fall out.

DO NOT operate instrument in any orientation other than vertical (block opening face up). Risk of fire or burn hazard may result due to excessive heat build up.

DO NOT operate on a flammable surface or near flammable materials.

DO NOT touch the well access surface of the instrument.

The block vent may be very hot due to the fan blowing across the heater block of the dry-well.

The calibration well temperature of the dry-well is the same as the actual display temperature, for example, if the instrument is set to 100°C and the display reads 100°C, the well is at 100°C.

The air over the well can reach temperatures greater than 100°C.

Probes and inserts may be hot and should only be inserted and removed from the instrument when the instrument is operating at temperatures below 50°C.

DO NOT turn off the instrument at temperatures higher than 100°C. This could create a hazardous situation. Select a set-point less than 100°C and allow the instrument to cool before turning it off.

The high temperatures present in dry-wells designed for operate at 100°C and higher may result in fires and severe burns if safety precautions are not observed.

ELECTRICAL HAZARD

These guidelines must be followed to ensure that the safety mechanisms in this instrument will operate properly. This instrument must be plugged into a 115 VAC (230 VAC optional), AC only electric outlet. The power cord of the instrument is equipped with a three-pronged grounding plug for your protection against electrical shock hazards. It must be plugged directly into a properly grounded three-prong receptacle. The receptacle must be installed in accordance with local codes and ordinances. Consult a qualified electrician.

DO NOT use an extension cord or adapter plug.

DO NOT operate this instrument without a properly grounded, properly polarized power cord.

DO NOT connect this instrument to a non-grounded, non-polarized outlet.

DO NOT use an extension cord or adapter plug.

If supplied with user accessible fuses, always replace the fuse with one of the same rating, voltage, and type.

Always replace the power cord with an approved cord of the correct rating and type.

HIGH VOLTAGE is used in the operation of this equipment. **SEVERE INJURY** or **DEATH** may result if personnel fail to observe safety precautions. Before working inside the equipment, turn power off and disconnect power cord.

1.3.2 Cautions

To avoid possible damage to the instrument, follow these guidelines:

DO NOT plug the instrument into 230V if the fuse holder reads 115V. This action will cause the fuses to blow and may damage the instrument.

DO NOT leave the sleeve(s) in the instrument for prolonged periods. Due to the high operating temperatures of the instrument, the sleeves should be removed after each use and buffed with a Scotch-Brite® pad or emery cloth.

Always operate this instrument at room temperatures stated in Section 2.2, Environmental Conditions. Allow sufficient air circulation by leaving at least 6 inches (15 cm) of clearance around the instrument. Overhead clearance is required. **DO NOT** place the instrument under any structure.

Component lifetime can be shortened by continuous high temperature operation.

DO NOT use fluids to clean out the well. Fluids could leak into electronics and damage the instrument.

DO NOT introduce any foreign material into the probe hole of the insert. Fluids, etc. can leak into the instrument causing damage.

DO NOT change the values of the calibration constants from the factory set values. The correct setting of these parameters is important to the safety and proper operation of the calibrator.

DO NOT slam the probe sheath or sleeves into the well. This type of action can cause a shock to the sensor and affect the calibration.

The instrument and any thermometer probes used with it are sensitive instruments that can be easily damaged. Always handle these devices with care. **DO NOT** allow them to be dropped, struck, stressed, or overheated.

DO NOT operate this instrument in an excessively wet, oily, dusty, or dirty environment. Always keep the well and inserts clean and clear of foreign material.

The dry-well is a precision instrument. Although it has been designed for optimum durability and trouble free operation, it must be handled with care. Always carry the instrument in an upright position to prevent the probe sleeves from dropping out.

If a mains supply power fluctuation occurs, immediately turn off the instrument. Power bumps from brown-outs could damage the instrument. Wait until the power has stabilized before re-energizing the instrument.

The probe and the block may expand at different rates. Allow for probe expansion inside the well as the block heats. Otherwise, the probe may become stuck in the well.

Most probes have handle temperature limits. Be sure the air temperature above the dry-well does not exceed the probe handle's temperature limit. If the probe handle limits are exceeded, the probe may be permanently damaged.

DO NOT move the instrument with the TPW cell inside. It can be easily broken.

1.4 Authorized Service Centers

Please contact one of the following authorized Service Centers to coordinate service on your Hart product:

Fluke, Hart Scientific Division

799 E. Utah Valley Drive
American Fork, UT 84003-9775
USA

Phone: +1.801.763.1600
Telefax: +1.801.763.1010
E-mail: support@hartscientific.com

Fluke Nederland B.V.

Customer Support Services
Science Park Eindhoven 5108
5692 EC Son
NETHERLANDS

Phone: +31-402-675300
Telefax: +31-402-675321
E-mail: ServiceDesk@fluke.nl

Fluke Int'l Corporation

Service Center - Instrimpex
Room 2301 Sciteck Tower
22 Jianguomenwai Dajie
Chao Yang District
Beijing 100004, PRC
CHINA

Phone: +86-10-6-512-3436
Telefax: +86-10-6-512-3437
E-mail: xingye.han@fluke.com.cn

Fluke South East Asia Pte Ltd.

Fluke ASEAN Regional Office
Service Center
60 Alexandra Terrace #03-16
The Comtech (Lobby D)
118502
SINGAPORE

Phone: +65-6799-5588
Telefax: +65-6799-5589
E-mail: anthony.ng@fluke.com

When contacting a Service Center for support, please have the following information available:

- Model Number
- Serial Number

- Voltage
- Complete description of the problem

2 Specifications and Environmental Conditions

2.1 Specifications

Table 2 9210 Specifications

Operating Range	-10°C to 125°C (14°F to 257°F)
TPW Cell Accuracy	±0.0005°C typical
TPW Cell Maintenance Time	6–10 hours typical
Display Accuracy	±0.25°C
Stability	±0.02°C
Resolution	0.01°C or °F (0.001°C or °F in program mode)
Display Scale	°C or °F, switchable
Pre-heat Wells	3 wells (for 3.18 mm, 6.35 mm, or 7.01 mm probes)
Immersion Depth	121 mm (4.75 inches) in TPW Cell, 171 mm (6.75 in) in optional comparison block
Comparison Block	Three multi-hole blocks, blanks and custom blocks available
Well-to-Well Gradient	±0.02°C (±0.036°F)
Fault Protection	Adjustable software cut-out
Cooling Time	Ambient to -5°C: 25 minutes
Heating Time	Ambient to 100°C: 45 minutes
Communications	RS-232
Ambient Temperature	5°C to 45°C (41°F to 113°F)
Power Requirements	115 V AC (±10%), 60 Hz, 1.5 A, 170 W 230 V AC (±10%), 50 Hz, 0.75 A, 170 W
Exterior Dimensions	22 cm W x 26 cm Dia x 49 cm H (8.75 in x 10.25 in x 19.25 in)
Weight	7 kg (15.5 lb) with comparison block
Safety	OVERVOLTAGE (Installation) CATEGORY II, Pollution Degree 2 per IEC1010-1

2.2 Environmental Conditions

Although the instrument has been designed for optimum durability and trouble-free operation, it must be handled with care. The instrument should not be operated in an excessively dusty or dirty environment. Maintenance and cleaning recommendations can be found in the Maintenance Section of this manual.

The instrument operates safely under the following conditions:

- temperature range: 5 – 45°C (41 – 113°F)
- ambient relative humidity: maximum 80% for temperature <31°C, decreasing linearly to 50% at 40°C
- pressure: 75kPa - 106kPa
- mains voltage within $\pm 10\%$ of nominal
- vibrations in the calibration environment should be minimized
- altitude does not effect the performance or safety of the unit

3 Quick Start

3.1 Unpacking

Unpack the instrument carefully and inspect it for any damage that may have occurred during shipment. If there is shipping damage, notify the carrier immediately.

Verify that the following components are present:

- 9210 Triple Point of Water Maintenance Apparatus
- Control Probe
- Power Cord
- User's Guide
- Comparison Block and Tongs (optional)
- Well Insulator
- Cell Pad Insulation
- Entry Well Pad (ear plugs)
- Cell Removal Tool
- 9930 Software with User's Guide
- RS-232 Cable

3.2 Setup

Place the instrument on a flat surface with at least 15 cm (6 in) of free space around and 46 cm (18 in) above the instrument. Install the power cord into the power entry module on the back of the instrument. Plug the power cord into a grounded mains outlet. Verify that the nominal voltage corresponds to that indicated on the back of the instrument.

Carefully insert the triple point of water cell into the well. (**DO NOT** drop it into the well.) The well must be clear of any foreign objects, dirt and grit before the cell is inserted. See Section 7 for more details.

Turn on the power to the instrument by toggling the switch on the power entry module located on the back of the instrument. The fan should begin quietly blowing air through the instrument and the controller display should illuminate after 3 seconds. After a brief self-test the controller should begin normal operation. If the unit fails to operate please check the power connection.

The display will begin to show the well temperature and the well heater will start operating to bring the temperature of the well to the set-point temperature.

3.3 Power

Plug the instrument power cord into a mains outlet of the proper voltage, frequency, and current capability (see Specifications on page 9). Turn the instrument on using the “POWER” switch underneath the unit. The instrument will turn on and begin to heat to the previously programmed temperature set-point. The front panel LED display will indicate the actual instrument temperature.

3.4 Setting the Temperature

Section 5.3 explains in detail how to set the temperature set-point on the instrument using the front panel keys. The procedure is summarized here.

- (1) Press “SET” twice to access the set-point value.
- (2) Press “UP” or “DOWN” to change the set-point value.
- (3) Press “SET” to program in the new set-point.
- (4) Press “EXIT” to return to the temperature display.

When the set-point temperature is changed the controller will power the well heaters on or off to raise or lower the temperature. The displayed well temperature will gradually change until it reaches the set-point temperature. The well may require 10 to 45 minutes to reach the set-point depending on the span and the scan rate. Another 15 minutes is required to stabilize within $\pm 0.1^{\circ}\text{C}$ of the set-point. Ultimate stability may take 15 to 20 minutes of stabilization time.

3.5 Changing Display Units

The instrument can display temperature in Celsius or Fahrenheit. The instrument is shipped from the factory set to Celsius. To change to Fahrenheit or back to Celsius there are two ways:

Press “SET” and “UP” simultaneously. This will change the display units.

or

Press the “SET” key three times from the temperature display to show

$$\text{U n} = \text{C}$$

Press the “UP” or “DOWN” key to change units.

Press “SET” to store changes.

4 Parts and Controls

The user should become familiar with the 9210 instrument parts. Successful use of the instrument is dependent upon knowledge of important components and their proper use.

4.1 Bottom Panel

On the bottom panel are the fan and feet. See Figure 1.

1. The cooling fan inlet is at the bottom of the unit. The cooling air circulating through the instrument keeps the electronics and the chassis cool. Keep the area immediately around the instrument clear to allow adequate ventilation.

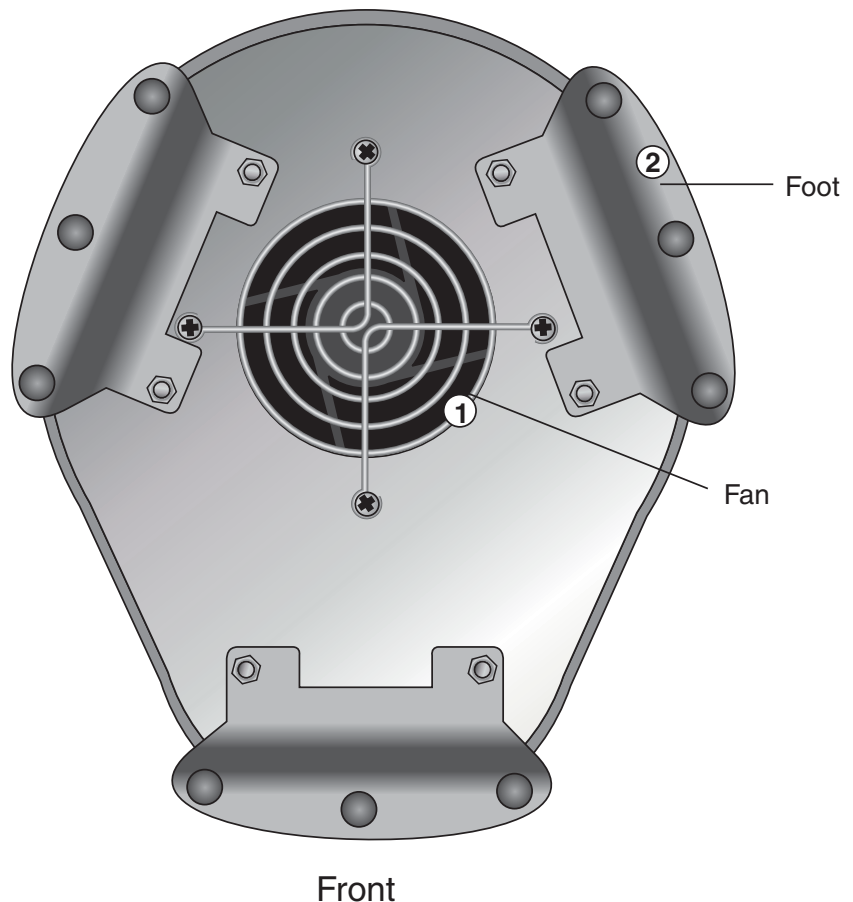

Figure 1 Bottom Panel

2. Three feet support the chassis permitting air space for the fan.

4.2 Front Panel

The front panel contains the digital display and the controller keypad. See Figure 2.

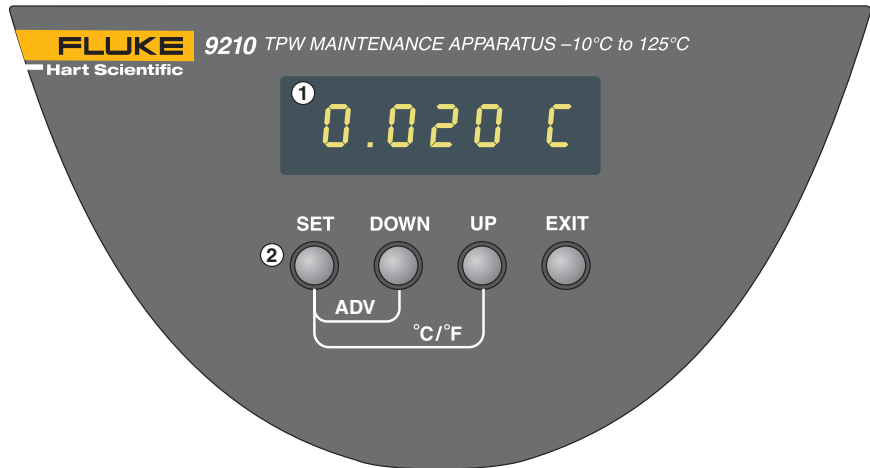

Figure 2 Front Panel

1. The digital display is an important part of the temperature controller because it not only displays set and actual temperatures but also displays various instrument functions, settings, and constants. The display shows temperatures in units according to the selected scale °C or °F.
2. The four button controller keypad allows easy setting of the set-point temperature. The control buttons (SET, DOWN, UP, and EXIT) are used to set the instrument temperature set-point, access and set other operating parameters, and access and set calibration parameters.

Setting the control temperature is done directly in degrees of the current scale and can be set to 0.01 of a degree Celsius or Fahrenheit.

The functions of the buttons are as follows:

SET - Used to display the next parameter in the menu and to store parameters to the displayed value.

DOWN - Used to decrement the displayed value of parameters.

UP - Used to increment the displayed value.

EXIT - Used to exit a function and to skip to the next function. Any changes made to the displayed value are ignored. Holding “EXIT” for about 1/2 a second returns control to the main display.

4.3 Top Panel

The primary feature of the top of the unit is the access to the temperature-controlled block. The top panel consists of the constant temperature block assembly, the control probe, the reference holes, and cooling air vents. See Figure 3.

1. The constant temperature block assembly is where the triple point of water cell is inserted or when the instrument is used as a temperature com-

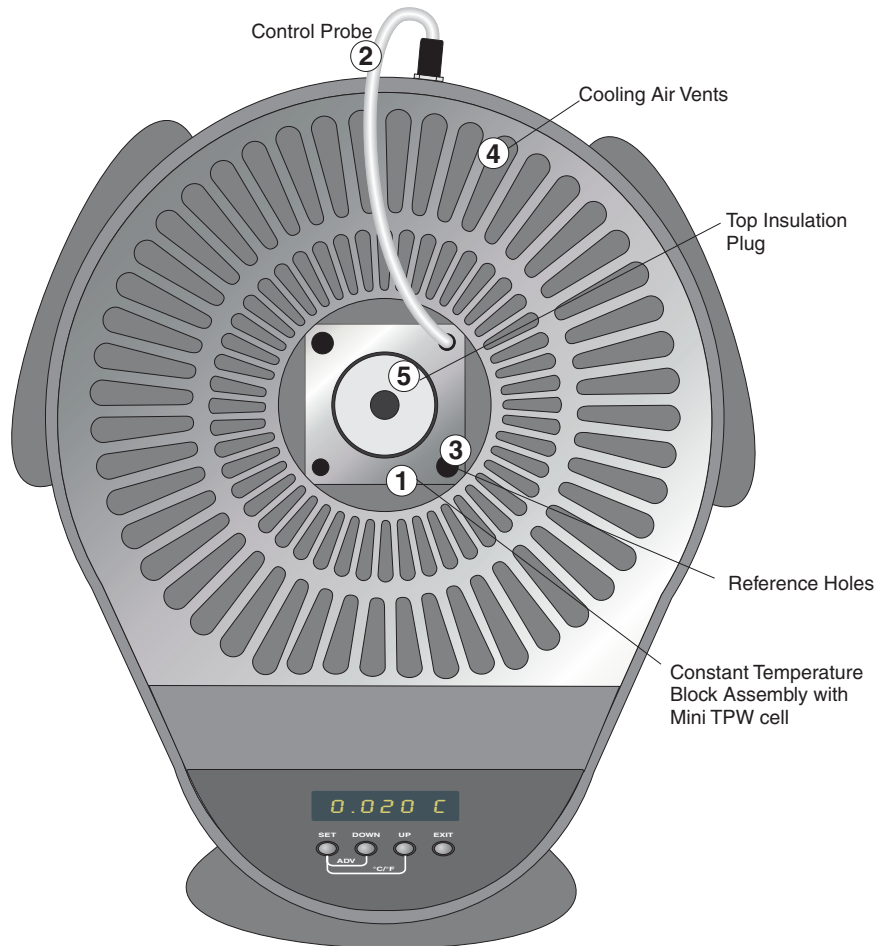

Figure 3 Top Panel

parator, where the pre-drilled inserts are placed for inserting the thermometers.

2. The control probe is inserted into the block and attaches to the back. The 9210 will not function without the control probe installed properly.
3. The reference holes can be used to pre-cool thermometers and for comparison and calibration of thermometers.
4. The cooling air vents in the top of the unit permit heated air to exit the unit.
5. The top insulation plug fits into the well over the TPW cell (see Section 7.2).

4.4 Rear Panel

The rear panel consists of the power connection, power switch, control probe connection and serial port. See Figure 4.

1. The power cord plugs in to the back of the instrument.
2. Set the power switch "ON" to operate the instrument and "OFF" to disconnect the power.
3. The control probe attaches to the back panel.
4. The serial port is a DB-9 male connector for interfacing the instrument to a computer or terminal RS-232 communications.

4.5 Thermal Block Assembly

The thermal block assembly holds the triple point of water cell or comparison insert and heats or cools to maintain the proper temperature. The thermal block assembly components are described below.

4.5.1 Thermal Block

The thermal block is specifically designed to contain the triple point of water cell. The thermal block also has reference holes for the control probe and test thermometers.

4.5.2 Heaters

The block assembly is heated or cooled as necessary to maintain the proper temperature with thermoelectric peltier devices.

4.5.3 Triple Point of Water Cell

The triple point of water cell is placed into the block. Use the removal tool to carefully insert or remove the cell.

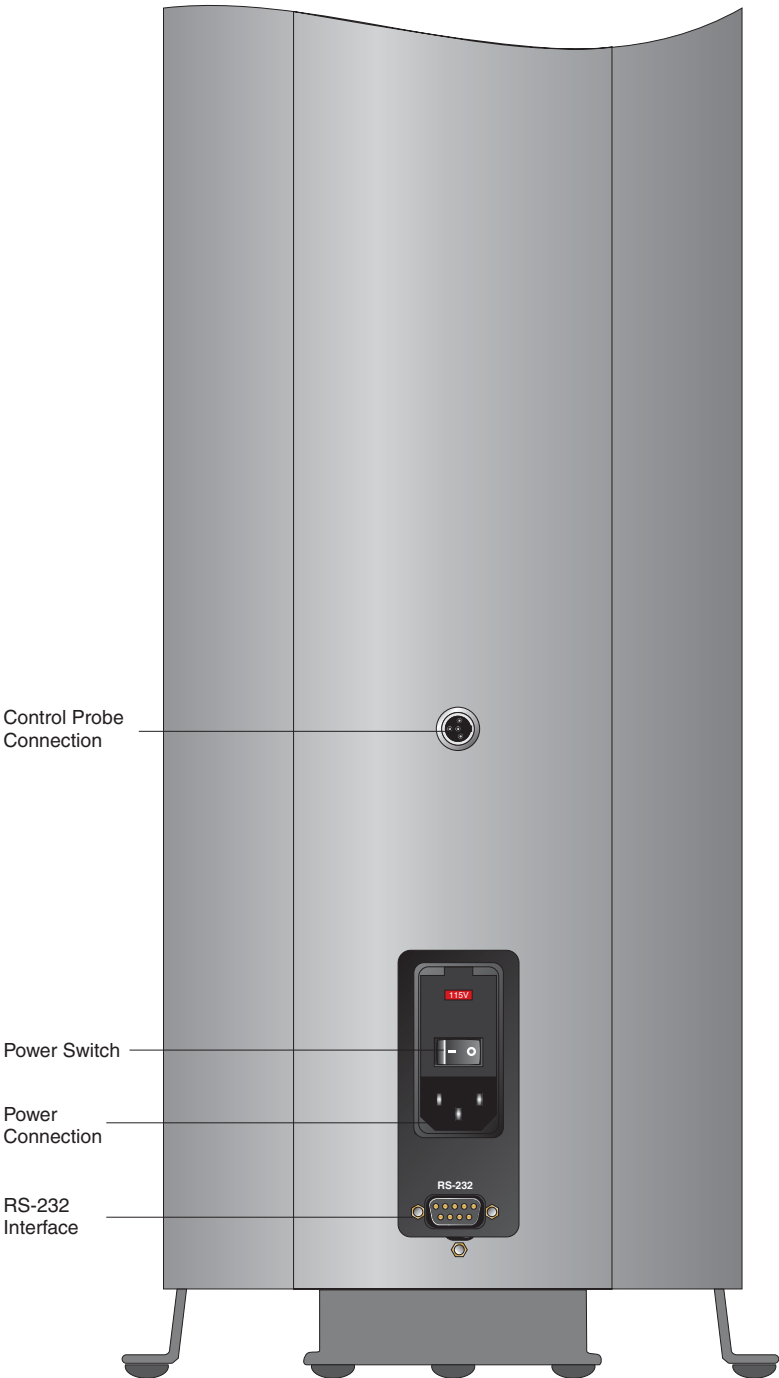

Figure 4 Rear Panel

4.5.4 Cell Pad

The cell pad is placed at the bottom of the well to help cushion and insulate the triple point of water cell.

4.5.5 Top Insulation Plug

The top insulation plug is placed over the triple point of water cell to help maintain the proper temperature. (See Section 7.2.)

4.5.6 Control Probe

The control probe is a high quality PRT with 4 leads. It must be fully inserted into the block, fitting snugly into the proper reference hole, and attached to the back of the instrument.

5 Controller Operation

This section discusses in detail how to operate the instrument temperature controller using the front control panel. By using the front panel key-switches and LED display, the user may monitor the well temperature, adjust the set-point temperature in degrees C or F, monitor the heater output power, adjust the controller proportional band, and program the operating parameters, program parameters, serial interface configuration, and the controller calibration parameters. Operation of the functions and parameters is shown in the flowchart in Figure 5 on page 20. This chart may be copied for reference.

In the following discussion a button with the word SET, UP, DOWN, or EXIT inside indicates the panel button while the dotted box indicates the display reading. Explanation of the button or display reading are to the right of each button or display value.

5.1 Well Temperature

The digital LED display on the front panel allows direct viewing of the actual well temperature. This temperature value is normally shown on the display. The units, C or F, of the temperature value are displayed at the right. For example,

 *Well temperature in degrees Celsius*

The temperature display function may be accessed from any other function by pressing the “EXIT” button.

5.2 Reset Cut-out

If the over-temperature cut-out has been triggered then the temperature display will alternately flash,

 *Indicates cut-out condition*

The message continues to flash until the temperature is reduced and the cut-out is reset. The cut-out has two modes - automatic reset and manual reset. The mode determines how the cut-out is reset which allows the instrument to heat up again. When in automatic mode, the cut-out will reset itself as soon as the temperature is lowered below the cut-out set-point. With manual reset mode the cut-out must be reset by the operator after the temperature falls below the set-point.

When the cut-out is active and the cut-out mode is set to manual (“reset”) then the display will flash “cut-out” until the user resets the cut-out. To access the reset cut-out function press the “SET” button.

 *Access cut-out reset function*

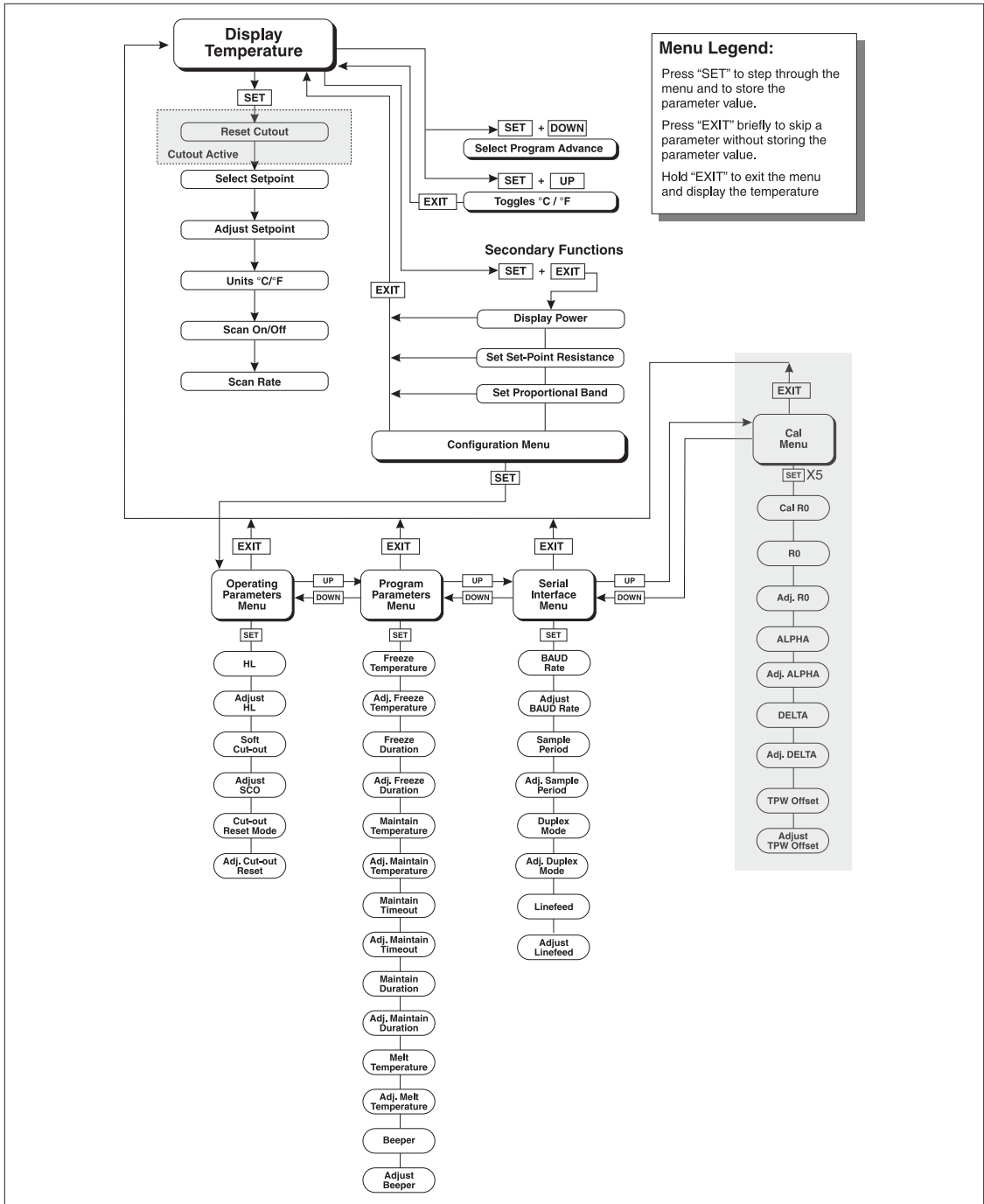

Figure 5 Control Flow Chart

The display will indicate the reset function.

 *Cut-out reset function*

Press “SET” once more to reset the cut-out.

 *Reset cut-out*

This will also switch the display to the set temperature function. To return to displaying the temperature press the “EXIT” button. If the cut-out is still in the over-temperature fault condition the display will continue to flash “cut-out”. The well temperature must drop a few degrees below the cut-out set-point before the cut-out can be reset.

5.3 Temperature Set-point

The temperature set-point can be set to any value within the range and resolution as given in the specifications. Be careful not to exceed the safe upper temperature limit of any device inserted into the well.

Setting the temperature involves selecting one of the eight (8) set-points in memory and then adjusting the set-point value.

5.3.1 Programmable Set-points

The controller stores eight (8) set-point temperatures in memory. The set-points can be quickly recalled to conveniently set the instrument to a previously programmed temperature set-point.

To set the temperature, first select the set-point memory. This function is accessed from the temperature display function by pressing “SET”. The number of the set-point memory currently being used is shown at the left on the display followed by the current set-point value.

 *Well temperature in degrees Celsius*

 *Access set-point memory*

 *Set-point memory 1, 0.0°C currently used*

To change the set-point memory to another preset value press “UP” or “DOWN”.

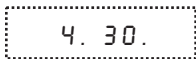
 *New set-point memory 4, 30.0°C*

Press “SET” to accept the new selection and access the set-point value.

 *Accept selected set-point memory*

Note: Pressing “SET” at this point turns off the program mode if it is on.

5.3.2 Set-point Value

The set-point value may be adjusted after selecting the set-point memory and pressing “SET”.

 *Set-point value in °C*

If the set-point value is correct, hold “EXIT” to resume displaying the well temperature. Press “UP” or “DOWN” to adjust the set-point value.

 *New set-point value*

When the desired set-point value is reached press “SET” to accept the new value and to access the temperature scale units. If “EXIT” is pressed, any changes made to the set-point are ignored.

 *Accept new set-point value*

5.4 Temperature Scale Units

The temperature scale units of the controller can be set by the user to degrees Celsius (°C) or Fahrenheit (°F). The units are used in displaying the well temperature, set-point, and proportional band.

Press “SET” after adjusting the set-point value to change display units.

 *Scale units currently selected*

Press “UP” or “DOWN” to change the units.

 *New units selected*

The units can also be changed quickly from the main display by pressing “SET” and “UP” together.

5.5 Scan

The scan rate can be set and enabled so that when the set-point is changed the instrument heats or cools at a specified rate (degrees per minute) until it reaches the new set-point. With the scan disabled the instrument heats or cools at the maximum possible rate.

5.5.1 Scan Control

The scan is controlled with the scan on/off function that appears in the main menu after the set-point function.

 *Scan function off*

Press “UP” or “DOWN” to toggle the scan on or off.

 *Scan function on*

Press “SET” to accept the present setting and continue.

 *Accept scan setting*

5.5.2 Scan Rate

The next function in the main menu is the scan rate. The scan rate can be set from 0.1 to 99.9°C/minute. The maximum scan rate, however, is actually limited by the natural heating or cooling rate of the instrument. This is often less than 100 °C/minute, especially when cooling.

The scan rate function appears in the main menu after the scan control function. The scan rate units are in degrees per minute, degrees C or F depending on the selected units.

 *Scan rate in °C/min.*

Press “UP” or “DOWN” to change the scan rate.

 *New scan rate*

Press “SET” to accept the new scan rate and continue.

 *Accept scan rate*

5.6 Program Advance

The program advance function allows the user to step through the maintain, freeze, and melt operations of the triple point of water realization. They are explained in detail in Section on Triple Point of Water Realization.

 +  *Access program advance*

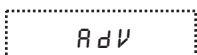
 *“Adv” flashes*

 *Displays one of the functions MAINT, FREEZE, or MELT*

Press “UP” or “DOWN” to view the desired function.

 *Accepts the new the operation*

5.7 Temperature Scale Units

To toggle between °C and °F, press the “SET” and “UP” keys simultaneously when the temperature is displayed.

5.8 Secondary Menu

Functions which are used less often are accessed within the secondary menu. Pressing “SET” and “EXIT” simultaneously and then releasing accesses the secondary menu. The first function in the secondary menu is the heater power display. (See Figure 5 on page 20.)

5.9 Heater Power

The temperature controller controls the temperature of the well by pulsing the heater on and off. The total power being applied to the heater is determined by the duty cycle or the ratio of heater on time to the pulse cycle time. By knowing the amount of heating the user can tell if the instrument is heating up to the set-point, cooling down, or controlling at a constant temperature. Monitoring the percent heater power lets the user know the stability of the well temperature. With good control stability the percent heating power should not fluctuate more than $\pm 1\%$ within one minute.

The heater power display is accessed in the secondary menu. Press “SET” and “EXIT” simultaneously and release. The heater power is displayed as a percentage of full power.

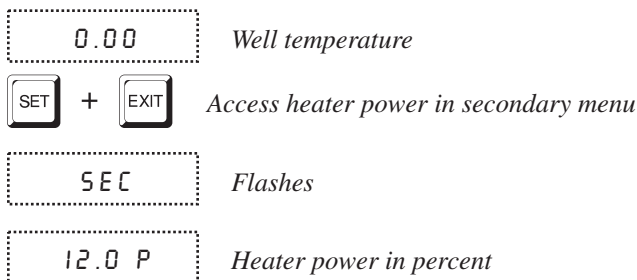

To exit out of the secondary menu press “EXIT” and hold for a brief moment. To continue on to the proportional band setting function press “EXIT” momentarily or “SET”.

5.10 Set-point Resistance

The set-point resistance is the resistance of the temperature sensor at the current temperature. Allow the temperature to stabilize at the desired set-point before taking its resistance. The set-point resistance function is available for diagnostic and calibration purposes.

Press “SET” and “EXIT” to enter the secondary menu and show the heater power. Then press “SET” twice to access the set-point resistance

 +  Access heater power in secondary menu

 Flashes “5 EC” and then displays the heater power setting

 Heater power in percent

 Access set-point resistance

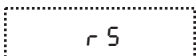
 Flashes “r 5” (Set-point Resistance) and then displays the setting

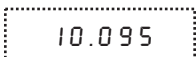
 Resistance in ohms

5.11 Proportional Band

In a proportional controller such as this, the heater output power is proportional to the well temperature over a limited range of temperatures around the set-point. This range of temperature is called proportional band. At the bottom of the proportional band the heater output is 100%. At the top of the proportional band the heater output is 0. Thus as the temperature rises the heater power is reduced, which consequently tends to lower the temperature back down. In this way the temperature is maintained at a fairly constant temperature.

The temperature stability of the well and response time depend on the width of the proportional band. If the band is too wide the well temperature deviates excessively from the set-point due to varying external conditions. This deviation is because the power output changes very little with temperature and the controller does not respond well to changing conditions or noise in the system. If the proportional band is too narrow the temperature may swing back and forth because the controller overreacts to temperature variations. For best control stability the proportional band must be set for the optimum width.

The proportional band width is set at the factory to about 8.0°C. The proportional band width may be altered by the user to optimize the control characteristics for a particular application.

The proportional band width is easily adjusted from the front panel. The width may be set to discrete values in degrees C or F depending on the selected units. The proportional band adjustment can be accessed within the secondary menu. Press “SET” and “EXIT” to enter the secondary menu and show the heater power. Then press “SET” twice to access the proportional band.

 +  Access heater power in secondary menu

 Flashes "SEC" and then displays the heater power setting

 Heater power in percent

 Access set-point resistance

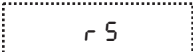
 Flashes "r 5" (Set-point Resistance) and then displays the setting

 Resistance in ohms



 Flashes "P r o P" and then displays the setting

 Proportional band setting

To change the proportional band press "UP" and "DOWN".

 New proportional band setting

To store the new setting press "SET". Press "EXIT" to continue without storing the new value.

 Accept the new proportional band setting

5.12 Controller Configuration

The controller has a number of configuration and operating options and calibration parameters that are programmable via the front panel. These are accessed from the secondary menu after the proportional band function by pressing "SET". "C o n F i g" flashes and then the name of the first parameter menu "P R R" is displayed. Pressing "SET" again enters the first of four groups of configuration parameters: operating parameters, program parameters, serial interface parameters, and calibration parameters. The groups are selected using the "UP" and "DOWN" keys and then pressing "SET". (See Figure 5 on page 20)

5.13 Operating Parameters

The operating parameters menu is indicated by,

 Operating parameters menu

Press “SET” to enter the menu. The operating parameters menu contains the High Limit (HL) parameter, the Soft Cut-out parameter, and the Cut-out Reset mode parameter.

5.13.1 High Limit

The High Limit parameter adjusts the upper set-point temperature. The factory default and maximum are set to 126°C. For safety, a user can adjust the High Limit parameter down so the maximum temperature set-point is restricted.

HL

Flashes “HL” (High Limit parameter) and then displays the setting

H = 100

Current HL setting

Adjust the HL parameter using “UP” or “DOWN”

H = 60

New High Limit setting

Press “SET” to accept the new High Limit parameter and to access the Soft Cut-out parameter.

5.13.2 Soft Cut-out

The next parameter in this menu is the Soft Cut-out. The Soft Cut-out parameter is used by the controller to shut down the unit during over-temperature conditions. If the temperature of the unit is ever greater than the Soft Cut-out temperature the controller shuts itself down and displays, alternately, “SCtOut” and “Err 0”.

SCtOut

Flashes “SCtOut” (Soft Cut-out parameter) and then displays the setting

100

Current value

Adjust this parameter by using “UP” or “DOWN”.

70

New Soft Cut-out setting

Press “SET” to accept the new parameter and to access the Cut-out Reset Mode.

5.13.3 Cut-out Reset Mode

The final parameter in this menu is the Cut-out Reset Mode. The Cut-out Reset Mode determines whether the cut-out resets automatically when the well temperature drops to a safe value or must be manually reset by the operator.

CuT o r St

Flashes "CuT o r St" (Cut-out reset mode parameter) and then displays the setting

RuT o

Current setting

To change to manual reset mode press "UP" or "DOWN".

r St

New Cut-out reset for manual reset

Press "SET" to accept the new parameter.

5.14 Program Parameters

The program parameters menu is indicated by,

Pr o G

Program parameters menu

Press "SET" to enter the menu. The Program parameters menu contains the parameters used for triple-point of water realization (see Section 7).

5.14.1 Freeze Temperature

The Freeze Temperature parameter sets the temperature to initiate the triple point of water cell freeze.

F r E E Z E

Flashes "F r E E Z E" and then displays the value

-4.00

Current Freeze Temperature setting

Adjust this parameter by using the "UP" or "DOWN" button. Press "SET" to accept the new value and to display the next parameter.

5.14.2 Freeze Duration

During the triple point of water freezing process the triple point of water cell is cooled to the Freeze Temperature and held for the Freeze Duration (in minutes). After this time the display flashes "r E R d Y" and the beeper sounds, if enabled, prompting the operator to remove the cell and shake it to freeze it.

d u r R t

Flashes "d u r R t" then displays the value of Freeze Duration

5.0

Current Freeze Duration, in minutes

Adjust this parameter using the "UP" or "DOWN" buttons. Press "SET" to store the new value.

5.14.3 Maintain Temperature

The next step after freezing a triple point of water cell is to maintain the cell at a constant, proper Maintain Temperature to keep the water partially frozen, partially melted. The Maintain Temperature can be adjusted as necessary.

nnRiT

Flashes "nnRiT" then displays the Maintain Temperature

0.01

Current Maintain Temperature

Adjust this parameter using the "UP" or "DOWN" buttons. Press "SET" to store the new value.

5.14.4 Maintain Timeout

Maintain Timeout determines whether the triple point of water cell is held at the Maintain Temperature indefinitely (OFF) or automatically melted after the Maintain Duration lapses (ON).

t, oUt

Flashes "t, oUt" then displays the Maintain Timeout

0n

Current Maintain Timeout state (enabled)

Set the parameter using the "UP" or "DOWN" buttons. Press "SET" to store the new setting.

5.14.5 Maintain Duration

If the Maintain Timeout is enabled, the triple point of water cell will be melted after the Maintain Duration, in minutes, lapses.

dUrRE

Flashes "dUrRE" then displays the Maintain Duration

480

Current Maintain Duration, in minutes

Adjust this parameter using the "UP" or "DOWN" buttons. Press "SET" to store the new value.

5.14.6 Melt Temperature

The Melt Temperature is the temperature to which the triple point of water is warmed to cause it to quickly and completely melt.

nnELt

Flashes "nnELt" then displays the Melt Temperature

`5.0` *Current Melt Temperature*

Adjust this parameter using the "UP" or "DOWN" buttons. Press "SET" to store the new value.

5.14.7 **Beeper**

The Beeper, when enabled, helps alert the operator when the triple point of water cell has been cooled adequately to allow it to freeze.

`bEEPEr` *Flashes "bEEPEr" then displays the Beeper option*

`0n` *Current Beeper state (enabled)*

Set the parameter using the "UP" or "DOWN" buttons. Press "SET" to store the new value.

5.15 **Serial Interface Parameters**

The serial RS-232 interface parameters menu is indicated by,

`SERIAL` *Serial RS-232 interface parameters menu*

The serial interface parameters menu contains parameters which determine the operation of the serial interface. These controls only apply to instruments fitted with the serial interface. The parameters in the menu are: BAUD rate, sample period, duplex mode, and linefeed.

5.15.1 **Baud Rate**

The baud rate is the first parameter in the menu. The baud rate setting determines the serial communications transmission rate. The baud rate of the serial communications may be programmed to 300, 600, 1200, 2400, 4800, or 9600 baud. 2400 baud is the default setting.

`BAUD` *Flashes "BAUD" (Serial baud rate parameter) and then displays the setting*

`2400 b` *Current baud rate*

Adjust the baud rate by using "UP" or "DOWN".

`4800 b` *New baud rate*

Press "SET" to store the baud rate to the new value and to access the Sample Period.

5.15.2 Sample Period

The sample period is the next parameter in the serial interface parameter menu. The sample period is the time period in seconds between temperature measurements transmitted from the serial interface. If the sample rate is set to 5, the instrument transmits the current measurement over the serial interface approximately every five seconds. The automatic sampling is disabled with a sample period of 0.

SPEr

Flashes "SPEr" (Serial sample period parameter) and then displays the setting

SP=1

Current sample period (seconds)

Adjust the value with "UP" or "DOWN".

SP=60

New sample period

Press "SET" to store the sample period to the new value and to access the Duplex Mode.

5.15.3 Duplex Mode

The next parameter is the duplex mode. The duplex mode may be set to full duplex or half duplex. With full duplex any commands received by the instrument via the serial interface are immediately echoed or transmitted back to the device of origin. With half duplex the commands are executed but not echoed.

dUPL

Flashes "dUPL" (Serial duplex mode parameter) and then displays the setting

d=FULL

Current duplex mode setting

The mode may be changed using "UP" or "DOWN".

d=HALF

New duplex mode setting

Press "SET" to store the duplex mode to the new value and to access the the Linefeed.

5.15.4 Linefeed

The final parameter in the serial interface menu is the linefeed mode. This parameter enables (on) or disables (off) transmission of a linefeed character (LF, ASCII 10) after transmission of any carriage-return.

LF

Flashes "LF" (Serial linefeed parameter) and then displays the setting

`LF=0n` *Current linefeed setting*

The mode may be changed using “UP” or “DOWN” and pressing “SET”.

`LF=0FF` *New linefeed setting*

Press “SET” to store the new linefeed value.

5.16 Calibration Parameters

The operator of the instrument has access to a number of the calibration constants namely R0, ALPHA, DELTA, and the triple point of water offset (tPOS). These values are set at the factory and must not be altered. The correct values are important to the accuracy and proper and safe operation of the instrument. Access to these parameters is available to the user only so that in the event that the controller memory fails the user may restore these values to the factory settings. The user should have a list of these constants and their settings with manual.



WARNING: *DO NOT change the values of the instrument calibration constants from the factory set values. The correct setting of these parameters is important to the safety and proper operation of the instrument.*

The calibration parameters menu is indicated by,

`CR L` *Calibration parameters menu*

Press “SET” five times to enter the menu. Then press EXIT to skip the tPOS calibration.

The calibration parameters R0, ALPHA, and DELTA characterize the resistance-temperature relationship of the platinum control sensor. These parameters may be adjusted by an experienced user to improve the accuracy of the instrument.



WARNING: *Calibration parameters should only be changed by trained personnel. The correct setting of these parameters is important to the safety and proper operation of the instrument..*

5.16.1 R0

This probe parameter refers to the resistance of the control probe at 0°C. The value of this parameter is set at the factory for best instrument accuracy.

5.16.2 ALPHA

This probe parameter refers to the average sensitivity of the probe between 0 and 100°C. The value of this parameter is set at the factory for best instrument accuracy.

5.16.3 DELTA

This probe parameter characterizes the curvature of the resistance-temperature relationship of the sensor. The value of this parameter is set at the factory for best instrument accuracy. should have a list of these constants and their settings with manual.

5.16.4 Triple Point of Water Offset (tPOS)

In order to properly maintain the Triple Point of Water Cell, the accuracy of the 9210 near the triple point (0.01°C) must be very precise, within 0.02 °C or better. The tPOS may need to be calibrated periodically to ensure this accuracy. This parameter allows one to calibrate the control probe in reference to the triple point of water. The tPOS calibration parameter only affects the operation of the instrument at the triple point of water temperature (0.01 °C). The TPW Cell must be in the triple-point state to perform the tPOS calibration. During calibration, the control probe is removed from the block and inserted into the TPW cell. tPOS is then adjusted until the display shows exactly 0.01°C. While the control probe is in the triple point of water cell the controller is unable to use it to control the temperature. For this reason, while in the tPOS calibration mode, active control is suspended and the controller simply outputs constant power to the heater.



NOTE: *The calibration must be done fairly quickly, in less than two minutes, or the block temperature may drift excessively and the accuracy of the tPOS value may be degraded.*



NOTE: *If the TPW Cell is not at the triple point state, the tPOS cannot be adjusted and the tPOS calculation below will produce a very large positive or negative value.*

The tPOS calibration proceeds as follows.

1. The instrument needs to be stable at 0.01 °C and the TPW Cell in the instrument needs to be in the triple point state (procedure in Chapter 8) to proceed with this calibration. If this is not the case, set the instrument to 0.01 °C, achieve a triple point state in the TPW Cell, and allow the instrument to stabilize at 0.01 °C before continuing.
2. From the main process temperature display, press and hold SET and EXIT until “SEC” is displayed. Press SET until “PAR” is displayed. Press UP until “CAL” is displayed. Press SET (5 times) until “CAL?” is dis-

played. "CAL?" will only display for a couple seconds before tPOS calibration mode is automatically started.



NOTE: The EXIT key can be used at any time to exit the tPOS calibration mode.

3. The instrument display flashes the temperature of the control probe temperature. As stated above, the instrument will supply a constant power to the heater in this mode.



CAUTION: The TPW Cell and/or control probe can be broken or damaged if care is not used when placing the control probe in the TPW Cell.

4. Remove the control probe from the block and place it in the TPW cell. The instrument displays the TPW Cell temperature. Wait for the temperature to stabilize (approximately 45 seconds).
5. Write down the temperature displayed.

Example: -0.200

6. Add the temperature from step 4 to 0.01 °C.

Example: $0.01 + (-0.200) = -0.190$

7. Add the result from step 5 to the current tPOS value.

Example:

Current tPOS = 0.125

New tPOS = $0.125 + (-0.190) = -0.065$



NOTE: If the new calculated tPOS value is greater than is ± 0.300 , the TPW Cell may not be at the triple point state and the procedure in Chapter 8 may need to be redone to properly perform this calibration.

8. Access the tPOS parameter in the CAL menu and enter the new calculated value for tPOS into the controller.



NOTE: For best results, return the control probe to its position in the block, return to the main process temperature display and wait for the instrument to stabilize at 0.01 °C for five to ten minutes before repeating the steps above.

9. Repeat steps 2 through 8 until the CAL? Temperature is within ± 0.003 °C.

10. Once calibration is complete, return the control probe to its proper position in the block and return to the main process temperature display.

6 Digital Communication Interface

The 9210 is capable of communicating with and being controlled by other equipment through the digital serial interface.

With a digital interface the instrument may be connected to a computer or other equipment. This allows the user to set the set-point temperature, monitor the temperature, and access any of the other controller functions, all using remote communications equipment. Communications commands are summarized in Table 3 on page 40.

6.1 Serial Communications

The instrument is installed with an RS-232 serial interface that allows serial digital communications over fairly long distances. With the serial interface the user may access any of the functions, parameters and settings discussed in Section 5 with the exception of the BAUD rate setting.

6.1.1 Wiring

The serial communications cable attaches to the instrument through the DB-9 connector at the back of the instrument. Figure 6 shows the pin-out of this connector and suggested cable wiring. To eliminate noise the serial cable should be shielded with low resistance between the connector (DB-9) and the shield. If the unit is used in a heavy industrial setting, the serial cable must be limited to ONE METER in length.

6.1.2 Setup

Before operation the serial interface must first be set up by programming the BAUD rate and other configuration parameters. These parameters are programmed within the serial interface menu.

RS-232 Cable Wiring for IBM PC and Compatibles

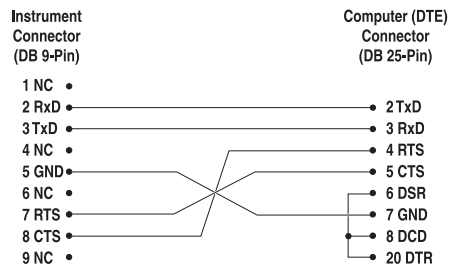
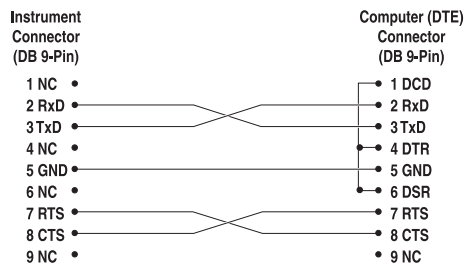

Figure 6 Serial Cable Wiring

To enter the serial parameter programming mode first press “EXIT” while pressing “SET” and release to enter the secondary menu. Press “SET” repeatedly until the display reads “P A R”. Press “UP” until the serial interface menu is indicated with “S E R I A L”. Finally press “SET” to enter the serial parameter menu. In the serial interface parameters menu are the BAUD rate, the sample rate, the duplex mode, and the linefeed parameter.

6.1.2.1 Baud Rate

The baud rate is the first parameter in the menu. The display will prompt with the baud rate parameter by showing “B A U D”. Press “SET” to choose to set the baud rate. The current baud rate value will then be displayed. The baud rate of the 9210 serial communications may be programmed to 300, 600, 1200, 2400, 4800, or 9600 baud. The baud rate is pre-programmed to 2400 baud. Use “UP” or “DOWN” to change the baud rate value. Press “SET” to set the baud rate to the new value or “EXIT” to abort the operation and skip to the next parameter in the menu.

6.1.2.2 Sample Period

The sample period is the next parameter in the menu and prompted with “S P E R”. The sample period is the time period in seconds between temperature measurements transmitted from the serial interface. If the sample rate is set to 5, the instrument transmits the current measurement over the serial interface approximately every five seconds. The automatic sampling is disabled with a sample period of 0. Press “SET” to choose to set the sample period. Adjust the period with “UP” or “DOWN” and then use “SET” to set the sample rate to the displayed value.

6.1.2.3 Duplex Mode

The next parameter is the duplex mode indicated with “D U P L”. The duplex mode may be set to half duplex (“H A L F”) or full duplex (“F U L L”). With full duplex any commands received by the instrument via the serial interface are immediately echoed or transmitted back to the device of origin. With half duplex the commands are executed but not echoed. The default setting is full duplex. The mode may be changed using “UP” or “DOWN” and pressing “SET”.

6.1.2.4 Linefeed

The final parameter in the serial interface menu is the linefeed mode. This parameter enables (“O N”) or disables (“O F F”) transmission of a linefeed character (LF, ASCII 10) after transmission of any carriage-return. The default setting is with linefeed on. The mode may be changed using “UP” or “DOWN” and pressing “SET”.

6.1.3 Serial Operation

Once the cable has been attached and the interface set up properly the controller immediately begins transmitting temperature readings at the programmed

rate. The serial communications uses 8 data bits, one stop bit, and no parity. The set-point and other commands may be sent via the serial interface to set the temperature set-point and view or program the various parameters. The interface commands are discussed in Section 6.2. All commands are ASCII character strings terminated with a carriage-return character (CR, ASCII 13).

6.2 Interface Commands

The various commands for accessing the instrument functions via the digital interface are listed in this section (see Table 3). These commands are used with the RS-232 serial interface. The commands are terminated with a carriage-return character. The interface makes no distinction between upper and lower case letters, hence either may be used. Commands may be abbreviated to the minimum number of letters that determines a unique command. A command may be used to either set a parameter or display a parameter depending on whether or not a value is sent with the command following a "=" character. For example, "s" <cr> will return the current set-point and "s=150.0" will set the set-point to 150.0 degrees.

In the following list of commands, characters or data within brackets, "[" and "]", are optional for the command. A slash, "/", denotes alternate characters or data. Numeric data, denoted by "n", may be entered in decimal or exponential notation. Characters are shown in lower case although upper case may be used. Spaces may be added within command strings and will simply be ignored. Backspace (BS, ASCII 8) may be used to erase the previous character. A terminating CR is implied with all commands.

Table 3 *Communications Command Summary*

Command Description	Command Format	Command Example	Returned	Returned Example	Acceptable Values
Display Temperature					
Read current set-point	s[etpoint]	s	set: 9999.99 {C or F}	set: 150.00 C	
Set current set-point to <i>n</i>	s[etpoint]= <i>n</i>	s=450			Instrument Range
Read units	u	u	u:{C or F}	u: C	
Read temperature	t	t	t: 9999.99{C or F}	t: 478.03 C	
Set temperature units:	u[nits]=<i>c/f</i>				C or F
Set temperature units to Celsius	u[nits]=c	u=c			
Set temperature units to Fahrenheit	u[nits]=f	u=f			
Read scan function	sc[an]	sc	scan: {ON or OFF}	scan: ON	
Set scan function:	sc[an]=on/off[f]				ON or OFF
Turn scan function on	sc[an]=on	sc=on			
Turn scan function off	sc[an]=off[f]	sc=of			
Read scan rate	sr[ate]	sr	srat: 999.99 {C or F}/min	srat: 10.0 C/min	
Set scan rate to <i>n</i> degrees per minute	sr[ate]= <i>n</i>	sr=5			.1 to 99.9
Read program state	adv	adv	adv:{FREEZE/MELT/MAINTAIN}	FREEZE	
Advance program state	adv={freeze/melt/maintain}	adv=melt			FREEZE, MELT or MAINTAIN
Secondary Menu					
Read heater power (duty cycle)	po[wer]	po	po: 999.9	po: 1	
Read proportional band setting	pr[op-band]	pr	pb: 999.9	pb: 15.9	
Set proportional band to <i>n</i>	pr[op-band]= <i>n</i>	pr=8.83			0.1 to 100
Read set-point resistance	*sr	*sr	999.999	121.091	
Configuration Menu					
Operating Parameters Menu					
Read high limit	hl	hl	hl: 999	hl: 925	
Set high limit	hl= <i>n</i>	hl=100			50–126
Read soft cut-out	cu	cu	cu: 9999.9	cu: 100	
Set soft cut-out setting:	cu[tout]=<i>n</i>				
Set soft cut-out to <i>n</i> degrees	cu[tout]= <i>n</i>	cu=100			0 to 150
Read cut-out mode	cm[ode]	cm	cm:{xxxx}	cm: AUTO	
Set cut-out mode	cm[ode]=[reset]/a[uto]				Reset or Auto
Set cut-out to be reset manually	cm[ode]=[reset]	cm=r			
Set cut-out to be reset automatically	cm[ode]=a[uto]	cm=a			
Program Parameters Menu					
Read freeze temperature	fr	fr	fr: 999.99 {C or F}	fr: -4.00 C	
Set freeze temperature	fr= <i>n</i>	fr=-4.50			-10 to 126
Read freeze duration	df	df	df: 99	df: 6	

Communications Command Summary cont.

Command Description	Command Format	Command Example	Returned	Returned Example	Acceptable Values
Set freeze duration	df= <i>n</i>	df=8			1 to 99
Read maintain temperature	ma	ma	ma: 99.999 [C or F]	ma: 0.010 C	
Set maintain temperature	ma= <i>n</i>	ma=0.01			-10 to 126
Read maintain duration	dm	dm	dm: 999/OFF	dm: 480	
Set maintain duration	dm= <i>n</i> /OFF	dm=500			OFF, 30 to 999
Read melt temperature	me	me	me: 999.99 [C or F]	me: 5.00 C	
Set melt temperature	me= <i>n</i>	me=5.00			-10 to 126
Read beeper setting	bee[<i>p</i>]	bee	beep: on/off	beep: on	
Set beeper	bee[<i>p</i>]=on/off[<i>f</i>]	bee=off			OFF, ON
Serial Interface Menu					
Read serial sample setting	sa[<i>mple</i>]	sa	sa: 9	sa: 1	
Set serial sampling setting to <i>n</i> seconds	sa[<i>mple</i>]= <i>n</i>	sa=0			0 to 4000
Set serial duplex mode:	du[<i>plex</i>]=f[<i>ull</i>]/h[<i>alf</i>]				FULL or HALF
Set serial duplex mode to full	du[<i>plex</i>]=f[<i>ull</i>]	du=f			
Set serial duplex mode to half	du[<i>plex</i>]=h[<i>alf</i>]	du=h			
Set serial linefeed mode:	lf[<i>eed</i>]=on/off[<i>f</i>]				ON or OFF
Set serial linefeed mode to on	lf[<i>eed</i>]=on	lf=on			
Set serial linefeed mode to off	lf[<i>eed</i>]=off[<i>f</i>]	lf=of			
Cal Menu					
Read R_0 calibration parameter	r[0]	r	r0: 999.999	r0: 100.7	
Set R_0 calibration parameter to <i>n</i>	r[0]= <i>n</i>	r=100.7			98.0 to 104.9
Read Alpha calibration parameter	al[<i>pha</i>]	al	al: 9.999999	al: 0.003865	
Set Alpha calibration parameter to <i>n</i>	al[<i>pha</i>]= <i>n</i>	al=0.003865			.002 to .006
Read Delta calibration parameter	de[<i>lta</i>]	de	de: 9.99	de: 1.50	
Set Delta calibration parameter	de[<i>lta</i>]= <i>n</i>	de=1.37			0 to 3
These commands are only used for factory testing.					
Miscellaneous (not on menus)					
Read firmware version number	*ver[<i>sion</i>]	*ver	ver.9999,9.99	ver.9210,v1.1	
Read structure of all commands	h[<i>elp</i>]	h	list of commands		
Legend:	<p>[] Optional Command data {} Returns either information <i>n</i> Numeric data supplied by user 9 Numeric data returned to user <i>x</i> Character data returned to user</p>				
Note:	<p>When DUPLEX is set to FULL and a command is sent to READ, the command is returned followed by a carriage return and linefeed. Then the value is returned as indicated in the RETURNED column.</p>				

7 Triple Point of Water Realization

This section explains the procedure for realizing the triple point of water (TPW) using a miniature TPW cell and the 9210.

7.1 General

The triple point of water is an extremely accurate temperature standard that can also be realized easily and reliably. The 9210 makes it even easier. It guides the operator through the process of freezing and maintaining the TPW cell and heats and cools the cell as needed. With the 9210 the triple point of water can be realized in just a few minutes with very little effort by the operator and can subsequently be used as a temperature standard for many hours while the triple point is maintained.

The triple point of water is a constant of nature. Pure water exists in a state of liquid, solid (ice), and vapor in equilibrium at only one pressure and temperature. By definition the temperature assigned to the triple point of water is exactly 273.16K or 0.01°C. The TPW cell is a sealed glass container partially filled with extremely pure liquid water and the air removed. With the volume of liquid water less than the volume inside the container the remaining space fills with water vapor. Simply freezing a portion of the water inside the cell creates the condition where the three phases of water exist together and the temperature will equilibrate to very nearly 0.01°C.

Since the TPW cell is constructed of glass it is somewhat fragile. It must be handled gently and with care. Additional danger exists since the water inside the cell will expand when frozen. Pockets of water in the cell surrounded by ice can expand when frozen with enough force to break the cell. *Completely freezing the cell should be avoided.* The TPW cell can also explode or be broken if it is heated much above room temperature since this will increase the vapor pressure of the water. *Never allow the 9210 to be heated over 40°C with the TPW cell installed.* Consider setting the soft cut-out to 40°C if the 9210 is only to be used for the maintenance of a TPW cell (see Section 5.13.2).

The water in the TPW cell will not necessarily begin to freeze when it is cooled to the triple point temperature. It can be supercooled many degrees below the triple point temperature before it begins to freeze spontaneously. The temperature and the point in time at which the cell will begin to freeze on its own is very unpredictable. However, a supercooled cell can be caused to freeze at will by gently shaking it. Thus, the preferred process for realizing the triple point of water with the 9210 is to cool a melted cell several degrees below the triple point temperature, remove the cell, shake it gently to initiate the freeze, then insert it back into the 9210. The cell must be completely melted to begin with or rather than supercooling it will freeze in an undesirable manner and possibly freeze solid potentially breaking the cell. When the supercooled cell is shaken, a small fraction of the water will suddenly freeze producing a slushy mixture of liquid water and ice. The freezing of the small amount of water releases enough latent heat to suddenly heat the cell back up to the triple point temperature.

Once the triple point of water is realized, the task of the 9210 is to preserve the mixture of liquid water and ice. The block temperature must be controlled at a temperature close enough to the triple point temperature to maintain the triple point for an adequate length of time. If the block temperature is too warm the ice in the cell will melt too quickly. If the block temperature is too cold the cell will freeze solid. This will not only eliminate the triple point condition but it could potentially cause the cell to break. For best results the block should be controlled to within 0.02°C of the triple point. Periodically calibrating the R0 parameter as explained in Section is recommended. With the 9210 properly calibrated and adjusted the TPW cell can be maintained for a full working day and used to calibrate many thermometers.

After the necessary work using the cell is completed or too much of the water in the cell becomes melted or frozen, the cell should be warmed to a temperature at which it will quickly and completely melt. This eliminates the danger of it freezing completely and prepares the cell for the next realization cycle.

In summary, the following steps are involved in the realization of the triple point of water:

- Install the TPW cell into the 9210
- Make sure the cell is melted and cooled to a few degrees above the triple point temperature.
- Supercool the cell a few degrees below the triple point temperature for a short time.
- Initiate the freeze by removing the cell, gently shaking it, and replacing it into the well.
- Maintain the cell at the triple point temperature while it is being used.
- Melt the cell again.

During these operations the 9210 controls the block temperature as required for each step. The 9210 temperature controller contains a program that drives the block to the temperatures appropriate for each step and prompts the operator when action is required. The program parameters are set from the front panel within the Program Menu (see Section 5.14). The program is started and advanced through the steps with the advance menu which is reached by pressing the SET and DOWN buttons simultaneously. The details of operating the 9210 to realize the triple point of water are explained for each step in the following sections.

7.2 Installing the TPW Cell

To start with, the TPW cell is placed in the well of the 9210. The well should be clean and free from any debris or objects other than the cell pad. The cell pad is a small piece of foam rubber placed at the bottom of the well. It serves to insulate the TPW cell allowing it a more uniform temperature gradient. It also helps to cushion the cell when it is removed or inserted. Make sure the pad is at the bottom of the well before inserting the TPW cell. Before installing the TPW

Cell in the instrument, place a 6.35 mm (0.25 inch) piece of the Entry Well Pad (earplug) into the bottom of the re-entrant well of the TPW Cell. The pad is used to cushion the cell from the probe and reduces the risk of breaking the TPW Cell.

The 9210 comes with a cell removal tool used to insert and remove the TPW cell from the block well. This tool is a small stick with spongy foam rubber covering one end. To install the TPW cell first insert the spongy end of the removal tool into the central well of the TPW cell so it is snug enough to hold onto the cell. Hold onto the outside of the cell with one hand and insert the cell half way into the block. Hold onto the removal tool with the other hand and gently lower the cell with the tool the rest of the way while releasing your grip on the outside of the cell.

Best results in maintaining the triple point are achieved when the thermal conductivity between the cell and the block is good. A small amount of denatured ethanol should be put into the block well around the TPW cell to fill the gaps and the re-entrant well of the TPW Cell. For best results, fill the well until the level of the ethanol is slightly above the top of the TPW Cell. Consider keeping a plastic squirt bottle filled with ethanol handy while operating the 9210 so the gap can be filled as needed. Do not put so much ethanol into the well that it overflows.

The top insulation plug fits into the top of the block well over the TPW cell. It has a hole in the center through which thermometers can be inserted. The top insulation plug has two purposes. First, it helps ensure an even temperature profile in the block and cell allowing a longer lasting and more accurate triple-point realization. Second, it protects against excessive moisture condensation and ice buildup at the top of the cell and block. Condensation can lead to corrosion over the long term and freezing water can damage the block. Always operate the 9210 with the top insulation plug installed when the block temperature is near 0°C or lower.

7.3 Melting the Cell in Preparation for Freezing

The TPW cell must be completely melted before it is frozen it again. If there is any possibility of ice remaining in the cell then warm it up to about 5°C to quickly and completely melt the ice. This can be done easily by advancing the temperature controller's program to the Melt state as follows.

Press SET and DOWN simultaneously to reach the Advance Program Menu.

 *Flashes "A D V" indicating the Advance Program Menu*

 *Displays the next program step in the sequence*

If the displayed program step is anything other than "F R E E Z E" press UP or DOWN to select "F R E E Z E". Press SET to enter the Melt state.

The controller will heat or cool the block to the Melt Temperature. Allow the cell to sit at the Melt Temperature for ten minutes or as long as is necessary to ensure that any ice is completely melted. The Melt Temperature is set to 5°C by default. If necessary, it can be adjusted (see Section 5.14.6).

7.4 Supercooling the Cell

The next step is to supercool the cell so it can be frozen. The controller program should be advanced to the Freeze state.

Press SET and DOWN simultaneously to reach the Advance Program Menu.

`ADY` Flashes “ADY” indicating the Advance Program Menu

`FREEZE` Displays the next program step in the sequence

If the displayed program step is anything other than “FREEZE” press UP or DOWN to select “FREEZE”. Press SET to enter the Freeze state.

After advancing to the Freeze state the controller will cool the block down to the Freeze Temperature and remain at that temperature for the Freeze Duration.

The Freeze Temperature should be as cold as possible to allow as much of the water to freeze as possible when the cell is shaken but not so cold that the cell has the potential for freezing on its own. Normally, the Freeze Temperature is set to -4.5°C. If necessary, this can be adjusted (see Section 5.14.1).

The Freeze Duration should be no longer than is necessary for the cell to reach the Freeze Temperature or the potential for the cell freezing on its own will exist. Normally, the Freeze Duration is set to 6 minutes. If necessary, this can be adjusted (see Section 5.14.2).

After the Freeze Duration lapses the 9210 will signal for the operator to initiate the freeze. The display will flash “ready”. If the beeper is enabled (see Section 6.14.7) the 9210 will also beep. The cell is now ready for the next step.

`READY` Flashes “READY” indicating the operator needs to initiate freezing

Again, the cell must not be left in the supercooled state too long or it might freeze on its own. To help protect against this the controller will automatically return to the Melt state if the operator fails to advance the program to the Maintain state within about 15 minutes of the ready signal.

7.5 Freezing the Cell

Once the cell has been supercooled it is ready to be frozen. Remove the top insulation plug. Insert the removal tool into the TPW cell's center well so it is snug enough to be able to lift the cell out of the well. Lift the cell half way out

of the well with the removal tool then grasp the cell with your free hand and pull it the rest of the way out. Always be careful while handling the TPW cell to ensure that it is not dropped, struck, or stressed. While holding the cell upright shake the cell side to side and observe the water suddenly freeze. Only about ten percent of the water will actually freeze but it will freeze uniformly throughout the cell producing a slushy mixture. Replace the cell into the block using the removal tool. Replace the top insulation plug. The 9210 must now be advanced to the Maintain state.

7.6 Maintaining the Triple Point

Immediately after freezing the cell, the controller program must be advanced to the Maintain state. Leaving the program in the Freeze state will cause continued freezing of the cell with the possibility of breaking it.

`r E R d Y`

Flashes “r E R d Y” indicating the operator needs to initiate freezing of the cell

After freezing the cell press SET and DOWN simultaneously to reach the Advance Program Menu.

`A d V`

Flashes “AdV” indicating the Advance Program Menu

`M A I N T`

Displays the next program step in the sequence

If the displayed program step is anything other than “M A I N T” press UP or DOWN to select “M A I N T”. Press SET to enter the Maintain state.

After advancing to the Maintain state the ready indication and the beeper will stop. The controller will ramp up from the Freeze Temperature to the Maintain Temperature and hold steady at that temperature.

Allow about 15 minutes for the block to reach the Maintain Temperature and equilibrate. Now the triple point is ready to be used as a temperature standard. As long as there is a uniform distribution of liquid water and ice in the TPW cell its temperature will remain at 0.01°C with an accuracy of typically 0.0005°C or better. You may use a small amount of ethanol in the TPW cell’s center well to improve thermal contact between the cell and thermometers placed in it. For best results, follow the instructions on filling the well with ethanol in Section 7.2, Installing the TPW Cell.

The block must be kept at just the right temperature so that a uniform distribution of liquid water and ice is preserved in the TPW cell from top to bottom. If the block temperature is too warm the ice will melt and the triple point condition will be lost. If the block temperature is too cold too much of the water may freeze, the triple point condition will be lost, and the cell may be broken due to the expansion of the freezing water. The Maintain Temperature is set to 0.01°C by default. If necessary, it can be adjusted (see Section 5.14.3). If the cell tends to freeze too much over several hours increase the maintain temperature

slightly. If the cell tends to melt too quickly decrease the maintain temperature slightly. If necessary, repeat the R0 calibration periodically as explained in Section 9. The triple point condition will last longer if you do not insert warm thermometers into the cell. Use the reference holes in the block to precool them first. With proper care the triple point can be made to last 6 to 10 hours.

7.7 Melting the Cell After Use

After the necessary work using the cell is completed or too much of the water in the cell becomes melted or frozen, the cell should be warmed to a temperature at which it will quickly and completely melt. This eliminates the danger of it freezing completely and prepares the cell for the next realization cycle. The controller will automatically return to the Melt state after a certain length of time has elapsed if this feature is enabled. The Maintain Timeout option enables or disables this feature (see Section 5.14.4). The Maintain Duration parameter sets the length of time the controller will wait in the Maintain state before returning to the Melt state (see Section 5.14.5).

8 Calibration Procedure

As explained in Section 8, best results in realizing the triple point of water are obtained when the 9210 is properly calibrated. If the 9210 is only used for maintaining the TPW cell then regularly calibrating R0 as explained in section 6.16.1 is adequate. If the 9210 is to be used as a temperature standard to calibrate thermometers at other temperatures then it must be properly calibrated throughout its entire range. The complete calibration should be done at regular intervals such as once a year. The following sections explain the procedure for calibrating the 9210 over the full range.

8.1 Calibration Equipment

Calibration of the 9210 requires a standard thermometer that is adequately accurate and fits properly into one of the reference holes in the block. Recommended equipment includes a laboratory grade PRT with a length of 230 to 300 mm (9 to 12 inches) and a diameter of 4.76 or 6.35 mm (3/16 or 1/4 inches). The combined accuracy of the PRT and the readout which used to display the temperature should be 0.05°C or better.

8.2 Calibration Procedure

The accuracy of the 9210 over the full range is determined by the values of the calibration parameters R0, ALPHA, and DELTA. The calibration procedure involves measuring the error between the 9210 and the reference thermometer at several temperature throughout the range and adjusting the calibration parameters as necessary to reduce the errors to within acceptable limits. The stated accuracy of the 9210 can be found in the specification table in Section 2.1. Because of the way the calibration parameters affect the temperature the simplest way to proceed is to measure the errors at 0°C, 100°C, and then 50°C and adjust R0, ALPHA, and DELTA at each point respectively. Follow these steps:

1. If “as found” data is required then first measure the error at various temperatures throughout the range such as -10, 0, 25, 50, 75, 100, and 125°C. The errors are measured by setting the controller to the desired temperature, allowing the block to reach the temperature and stabilize, and reading the actual temperature of the block with the standard thermometer. If the measured errors are all within acceptable limits then no further action is required and following the remainder of this procedure is not necessary. If the accuracy needs to be improved continue with Step 2.
2. Set the set-point to 0°C and allow adequate time for the block to reach this temperature and stabilize. Adjust the R0 calibration parameter (see Section 5.16.1) to make the block temperature as measured with the standard thermometer match the set-point. The approximate ratio between a change in R0 and a change in temperature at 0°C is about 0.4 to 1. For

example, if the block temperature is high by 0.1°C at 0°C then reduce R0 by 0.04.

3. Set the set-point to 100°C and allow adequate time for the block to reach this temperature and stabilize. Adjust the ALPHA calibration parameter (see Section 5.16.2) to make the block temperature as measured with the standard thermometer match the set-point. The approximate ratio between a change in ALPHA and a change in temperature at 100°C is about 400 to 1. For example, if the block temperature is high by 0.1°C at 100°C then reduce ALPHA by 40.
4. Set the set-point to 50°C and allow adequate time for the block to reach this temperature and stabilize. Adjust the DELTA calibration parameter (see Section 6.16.4) to make the block temperature as measured with the standard thermometer match the set-point. The approximate ratio between a change in DELTA and a change in temperature at 50°C is about 4 to 1. For example, if the block temperature is high by 0.1°C at 50°C then decrease DELTA by 0.4.
5. Repeat Step 1 to ensure the 9210 is now accurate throughout the full range.

9 Maintenance

- The calibration instrument has been designed with the utmost care. Ease of operation and simplicity of maintenance have been a central theme in the product development. Therefore, with proper care the instrument should require very little maintenance. Avoid operating the instrument in an oily, wet, dirty, or dusty environment.
- If the outside of the instrument becomes soiled, it may be wiped clean with a damp cloth and mild detergent. Do not use harsh chemicals on the surface which may damage the paint.
- It is important to keep the well of the instrument clean and clear of any foreign matter.
- The instrument should be handled with care. Avoid knocking or dropping the instrument.
- If the comparison block is dropped, examine the comparison block for deformities before inserting it in the well. If there is any chance of jamming the comparison block in the well, file or grind off the protuberance.
- Do not drop the probes into the well. This type of action can cause a shock to the sensor or break the entrant well of a triple point of water cell.
- If a hazardous material is spilt on or inside the equipment, the user is responsible for taking the appropriate decontamination steps as out-lined by the national safety council with respect to the material.
- If the mains supply cord becomes damaged, replace it with a cord with the appropriate gauge wire for the current of the instrument. If there are any questions, contact an Authorized Service Center for more information.
- Before using any cleaning or decontamination method except those recommended by Hart, users should check with an Authorized Service Center to be sure that the proposed method will not damage the equipment.
- If the instrument is used in a manner not in accordance with the equipment design, the operation of the instrument may be impaired or safety hazards may arise.

10 Troubleshooting

This section contains information on troubleshooting and CE Comments

10.1 Troubleshooting Problems, Possible Causes, and Solutions

In the event that the instrument appears to function abnormally, this section may help to find and solve the problem. Several possible problem conditions are described along with likely causes and solutions. If a problem arises, please read this section carefully and attempt to understand and solve the problem. If the problem cannot otherwise be solved, contact an Authorized Service Center for assistance (see Section 1.4). Be sure to have the model number and serial number of your instrument available.

Problem	Possible Causes and Solutions
Incorrect temperature reading	<p>Incorrect R0 parameter. Find the value for R0 on the Report of Calibration that was shipped with the instrument (or from subsequent calibrations of the instrument). Reprogram the parameter into the 9210 memory (see Section 5.16.1, R0). Allow the instrument to stabilize and verify the accuracy of the temperature reading.</p> <p>Controller locked up. The controller may have locked up due to a power surge or other aberration. Initialize the system by performing the Factory Reset Sequence.</p> <p>Factory Reset Sequence. Hold the SET and EXIT buttons down at the same time while powering on the instrument. After the instrument displays <code>-i n i t-</code>, release the buttons. The display shows <code>-i n i t-</code>, then displays <code>9210</code>, then displays the firmware version, and then displays <code>R0 E0</code>. After performing the master reset sequence, all of the configuration parameters are reset to their default values. Reprogram the R0 parameter into the 9210 memory (see Section 5.16.1, R0) and any other applicable configuration parameters. Allow the instrument to stabilize and verify the accuracy of the temperature reading.</p>
Blank display after mains power applied	<p>Blown fuse. A fuse may have blown due to a power surge or failure of a component. Replace the fuse once. If the fuse blows a second time, it is likely caused by the failure of a component. Always replace the fuse with one of the same rating, voltage, and type. Never replace the fuse with one of a higher current rating.</p>
The Instrument heats or cools too quickly or too slowly	<p>Incorrect scan and scan rate settings. The scan and scan rate settings may be set to unwanted values. Check the Scan and Scan Rate settings. The scan may be off (if the unit seems to be responding too quickly). The scan may be on with the Scan Rate set low (if unit seems to be responding too slowly).</p>

Problem	Possible Causes and Solutions
The display shows any of the following: <i>Err 1</i> , <i>Err 2</i> , <i>Err 3</i> , <i>Err 4</i> , or <i>Err 5</i>	Controller problem. The error messages signify the following problems with the controller. <i>Err 1</i> - a RAM error <i>Err 2</i> - a NVRAM error <i>Err 3</i> - a Structure error <i>Err 4</i> - an ADC setup error <i>Err 5</i> - an ADC ready error Initialize the system by performing the Factory Reset Sequence describe above.
The display shows <i>Err 6</i>	Defective control sensor. The control sensor may be shorted, open or otherwise damaged. Disconnect the control sensor from the instrument. Measure the resistance of the control sensor. The resistance between pins 2 and 3 should be 1-2 ohms. The resistance between pins 1 and 4 should be 1-2 ohms. The resistance between pins 1 or 4 and 2 or 3 should be approximately 110 ohms at room temperature (25 °C). If it measures close to this, re-connect the sensor, and reapply power to the instrument. If the error message returns, there is a problem with the controller.

10.2 CE Comments

10.2.1 EMC Directive

Hart Scientific’s equipment has been tested to meet the European Electromagnetic Compatibility Directive (EMC Directive, 89/336/EEC). Selection of Light Industrial or Heavy Industrial compliance has been based on the intended use of the instrument. Units designed for use in a calibration laboratory have been tested to Light Industrial Standards. Units designed to be used in the “field” have been tested to both Light Industrial and Heavy Industrial Standards. The Declaration of Conformity for your instrument lists the specific standards to which the unit was tested.

10.2.2 Low Voltage Directive (Safety)

In order to comply with the European Low Voltage Directive (73/23/EEC), Hart Scientific equipment has been designed to meet the IEC 1010-1 (EN 61010-1) and IEC 1010-2-010 (EN 61010-2-010) standards.