

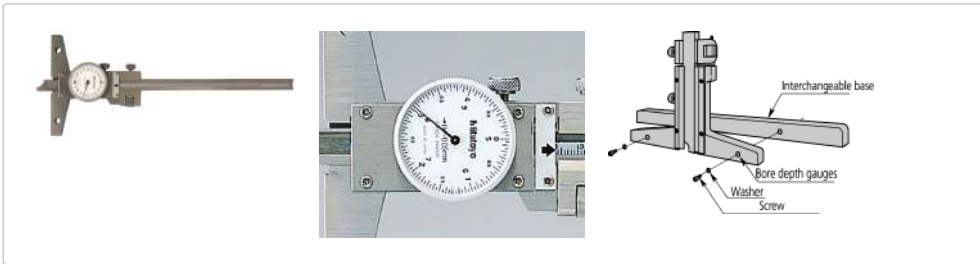

## Dial Depth Gauge 0-6", With Fine adjustment

Item number: 527-311-50



### Description

This dial depth gauge offers you the following benefits:

- The dial is very easy-to-read.
- Its base and measuring faces are hardened and micro-lapped for robustness.
- You can make fine adjustments.

### Features

Graduation:	<b>0,001"</b>
Accuracy:	<b>±0.001"</b>
Mass:	<b>280 g</b>
Base size :	<b>100 x 6.5 mm (W x T) mm</b>
Digital/Analog:	<b>Analog</b>
Inch-Metric:	<b>Inch</b>

### Dimensions

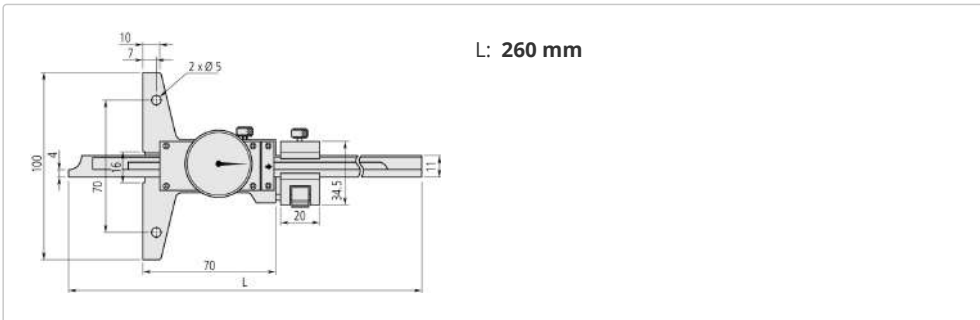

### Accessories

#### Optional accessories:



**Extension Base, Depth Gauge**  
**180mm width for up to 300mm Range**  
**900370**

Suggested retail price: **57.00 €\***



**Extension Base, Depth Gauge**  
**260mm width for up to 300mm Range**  
**900371**

Suggested retail price: **78.00 €\***



**Extension Base, Depth Gauge**  
**320mm width for up to 300mm Range**  
**900372**

Suggested retail price: **89.00 €\***