

# 6135A/PMU

Calibration System

## Operators Manual

## LIMITED WARRANTY AND LIMITATION OF LIABILITY

Each Fluke product is warranted to be free from defects in material and workmanship under normal use and service. The warranty period is one year and begins on the date of shipment. Parts, product repairs, and services are warranted for 90 days. This warranty extends only to the original buyer or end-user customer of a Fluke authorized reseller, and does not apply to fuses, disposable batteries, or to any product which, in Fluke's opinion, has been misused, altered, neglected, contaminated, or damaged by accident or abnormal conditions of operation or handling. Fluke warrants that software will operate substantially in accordance with its functional specifications for 90 days and that it has been properly recorded on non-defective media. Fluke does not warrant that software will be error free or operate without interruption.

Fluke authorized resellers shall extend this warranty on new and unused products to end-user customers only but have no authority to extend a greater or different warranty on behalf of Fluke. Warranty support is available only if product is purchased through a Fluke authorized sales outlet or Buyer has paid the applicable international price. Fluke reserves the right to invoice Buyer for importation costs of repair/replacement parts when product purchased in one country is submitted for repair in another country.

Fluke's warranty obligation is limited, at Fluke's option, to refund of the purchase price, free of charge repair, or replacement of a defective product which is returned to a Fluke authorized service center within the warranty period.

To obtain warranty service, contact your nearest Fluke authorized service center to obtain return authorization information, then send the product to that service center, with a description of the difficulty, postage and insurance prepaid (FOB Destination). Fluke assumes no risk for damage in transit. Following warranty repair, the product will be returned to Buyer, transportation prepaid (FOB Destination). If Fluke determines that failure was caused by neglect, misuse, contamination, alteration, accident, or abnormal condition of operation or handling, including overvoltage failures caused by use outside the product's specified rating, or normal wear and tear of mechanical components, Fluke will provide an estimate of repair costs and obtain authorization before commencing the work. Following repair, the product will be returned to the Buyer transportation prepaid and the Buyer will be billed for the repair and return transportation charges (FOB Shipping Point).

THIS WARRANTY IS BUYER'S SOLE AND EXCLUSIVE REMEDY AND IS IN LIEU OF ALL OTHER WARRANTIES, EXPRESS OR IMPLIED, INCLUDING BUT NOT LIMITED TO ANY IMPLIED WARRANTY OF MERCHANTABILITY OR FITNESS FOR A PARTICULAR PURPOSE. FLUKE SHALL NOT BE LIABLE FOR ANY SPECIAL, INDIRECT, INCIDENTAL, OR CONSEQUENTIAL DAMAGES OR LOSSES, INCLUDING LOSS OF DATA, ARISING FROM ANY CAUSE OR THEORY.

Since some countries or states do not allow limitation of the term of an implied warranty, or exclusion or limitation of incidental or consequential damages, the limitations and exclusions of this warranty may not apply to every buyer. If any provision of this Warranty is held invalid or unenforceable by a court or other decision-maker of competent jurisdiction, such holding will not affect the validity or enforceability of any other provision.

Fluke Corporation  
P.O. Box 9090  
Everett, WA 98206-9090  
U.S.A.

Fluke Europe B.V.  
P.O. Box 1186  
5602 BD Eindhoven  
The Netherlands

11/99

To register your product online, visit [register.fluke.com](http://register.fluke.com)

# Table of Contents

Chapter	Title	Page
<b>1</b>	<b>Introduction and Specifications.....</b>	<b>1-1</b>
	Introduction.....	1-3
	About this Chapter.....	1-3
	Standard Accessories.....	1-5
	Safety Information.....	1-6
	About the Manual Set.....	1-8
	Contact Fluke Calibration.....	1-9
	Performance Verification and Repair Information.....	1-9
	Calibration System Overview.....	1-10
	Components of the Calibration System.....	1-12
	Client PC.....	1-12
	Server PC.....	1-13
	6135A Three Phase Power Standard.....	1-14
	Symmetricom GPS Receiver.....	1-16
	6135A/PMU System Timing Unit.....	1-17
	6135A/PMU System Software Status Panel.....	1-19
	PMUCal Software.....	1-20
	Overview.....	1-20
	Monitor Screen.....	1-20
	Navigation Menu.....	1-21
	The System Status Panel.....	1-22
	General Specifications.....	1-23
	Input Power.....	1-23
	Dimensions.....	1-23
	Environment.....	1-23
	Standard and Agency Approvals.....	1-23
	Electrical Source Accuracy Specifications.....	1-23
	Performance Specifications for C37.118.1 Tests.....	1-23
	PMU Test: Limits to Range of Influence Quantities.....	1-24
	General Test limits.....	1-24
	Steady State Tests.....	1-24
	Modulation Tests.....	1-24
	Frequency Ramp Tests.....	1-24
	Input Step Change Tests.....	1-24

<b>2</b>	<b>Installation Instructions .....</b>	<b>2-1</b>
	About this Chapter .....	2-3
	Unpack and Inspect.....	2-3
	Install the Calibration System.....	2-4
	Pre-Installation Preparation .....	2-4
	Installation Procedure .....	2-5
	Install the PMUCal Software.....	2-5
	Configure the Client PC.....	2-6
	Configure Windows Firewall .....	2-6
	Network Connection Instructions.....	2-10
	Direct Connection Instructions .....	2-11
	Set Up the File Storage Directory.....	2-17
	Install the Test Files.....	2-19
<b>3</b>	<b>Software Operation .....</b>	<b>3-1</b>
	About this Chapter .....	3-3
	UUT Calibration Procedure .....	3-3
	Overview .....	3-3
	Calibration Procedure Information.....	3-4
	Calibration Compliance to IEEE C37.118.1-2011 .....	3-4
	About Synchrophasor Calibration .....	3-6
	Time to Complete a UUT Calibration .....	3-7
	Calibration Test Measurements .....	3-7
	Calibration Procedure Preparation.....	3-7
	UUT Configuration .....	3-8
	UUT and Simulator Personality Profiles.....	3-8
	UUT Personality Profile.....	3-8
	Simulator Personality Profile .....	3-11
	Testing Methods .....	3-12
	Automated Testing .....	3-14
	General and Custom Interactive Test Methods .....	3-14
	General Interactive Testing .....	3-15
	Custom Interactive Testing .....	3-15
	Interactive Test Sequence of Events.....	3-16
	Run the Test .....	3-16
	Set Up the Interactive Graph.....	3-17
	Analyze the Data on the Interactive Graph .....	3-17
	Modes of Operation .....	3-18
	Simulation Mode .....	3-19
	PMU Test Mode .....	3-19
	Standard Compliance Tests and Test Files .....	3-19
	Standard Compliance Tests and Subtests .....	3-21
	Steady State Compliance Tests .....	3-21
	Dynamic Compliance Tests .....	3-22
	Standard Compliance Tests File Naming Convention .....	3-23
	Automated Test List Files .....	3-25
	Test Results and Results Files.....	3-25
	About Result Files and the Active Results File .....	3-25
	Results Files Naming Convention .....	3-26
	Result File Save Options .....	3-27
	Results File Storage Directory.....	3-28
	Raw Data Files .....	3-28
	Test Report and Calibration Report.....	3-28



<b>4</b>	<b>UUT Calibration Setup .....</b>	<b>4-1</b>
	About this Chapter .....	4-3
	Safety Information .....	4-3
	General Operation Information .....	4-4
	Turn On the Calibration System .....	4-4
	Turn Off the Calibration System .....	4-4
	Calibration System Warm-up .....	4-4
	Connect the Calibration System to a UUT .....	4-4
	Prepare the UUT for Calibration .....	4-5
	Current Connections .....	4-6
	Voltage Connections .....	4-7
	UUT Data Cable Connection .....	4-8
	GPS Signal Cable Connection .....	4-8
	Communicate with the UUT .....	4-9
	Set Up a UUT Personality Profile .....	4-11
	Configure the UUT Phase Order .....	4-14
	UUT Connection Test .....	4-16
<b>5</b>	<b>Automated Testing .....</b>	<b>5-1</b>
	About this Chapter .....	5-3
	Automated Testing Overview .....	5-3
	Getting Started .....	5-3
	Run an Automated Test .....	5-4
	Incomplete Tests .....	5-6
	Make a New Automated Test .....	5-8
<b>6</b>	<b>General Testing .....</b>	<b>6-1</b>
	About this Chapter .....	6-3
	General Testing .....	6-3
	Test Configuration Instructions .....	6-6
	General Test Parameters .....	6-6
	Test Type Parameter .....	6-7
	Test Parameters .....	6-7
	Steady State Test Parameters .....	6-8
	Frequency Ramp Test Parameters .....	6-9
	Modulation Test Parameters .....	6-12
	Step Test Parameters .....	6-14
	Measurement Latency Test Parameters .....	6-15
	Run a Single Test .....	6-16
	Run a Custom Interactive Test .....	6-16
<b>7</b>	<b>Interactive Graphs, Results, and Reports .....</b>	<b>7-1</b>
	Introduction .....	7-3
	Interactive Graph .....	7-3
	Graph Configuration Window .....	7-4
	Make an Interactive Graph .....	7-4
	Example Interactive Graph Configurations .....	7-7
	One Source and One Input Graph Configuration Example .....	7-7
	Two Sources and One Input Graph Configuration Example .....	7-7
	Two Source and Two Inputs Graph Configuration Example .....	7-8
	Y-Axis Analysis Results Configuration Example .....	7-9
	Change the View of an Interactive Graph .....	7-10
	Zoom-in and Zoom-out of a Plot .....	7-10

	Undock and Dock a Panel .....	7-11
	Change the Displayed Data .....	7-11
	Change the look of the Plot .....	7-12
	Test Results .....	7-13
	Test Results Viewer .....	7-13
	View Test Results in the Results Viewer .....	7-13
	Log of Tests .....	7-14
	Test Reports .....	7-15
	Report Templates .....	7-15
	Create One Report .....	7-16
	Create Multiple Reports .....	7-16
	View a Report .....	7-18
<b>8</b>	<b>Troubleshooting, Maintenance, and Care .....</b>	<b>8-1</b>
	About this Chapter .....	8-3
	Troubleshooting .....	8-4
	General .....	8-4
	6135A/PMU System Timing Unit .....	8-4
	Server PC .....	8-5
	6135A Three Phase Power Standard .....	8-5
	GPS Receiver .....	8-6
	Network .....	8-6
	Calibration Software .....	8-7
	UUT .....	8-7
	Test Reports .....	8-9
	Cleaning .....	8-10
	Performance Verification and Repair Information .....	8-10
<b>9</b>	<b>Performance Verification .....</b>	<b>9-1</b>
	About this Chapter .....	9-3
	Prerequisites .....	9-3
	Equipment Required .....	9-3
	Procedures .....	9-3
	Verify Signal Alignment with the UTC .....	9-3
	Verify the Accuracy of the Timing Inputs .....	9-4
	Verify Step Timing Accuracy .....	9-5
	L1V Test .....	9-5
	L2V Test .....	9-7
	L3V Test .....	9-7
	<b>Appendices</b>	
	A Glossary .....	A-1

# List of Tables

Table	Title	Page
1-1.	Standard Equipment and Accessories .....	1-5
1-2.	Symbols.....	1-6
1-3.	Referenced Manuals.....	1-8
1-4.	Flule Calibration Service Centers .....	1-9
1-5.	Client PC Requirements.....	1-12
1-6.	Server PC Connections .....	1-14
1-7.	6135A Connections .....	1-16
1-8.	GPS Satellite Status Indicator Light.....	1-17
1-9.	The Timing Unit Connections.....	1-17
1-10.	Timing Unit Front Panel Indicator Lights.....	1-18
1-11.	System Software Status Panel .....	1-19
1-12.	Top Menu .....	1-21
1-13.	System Status Panel .....	1-22
3-1.	Accuracy Requirements .....	3-5
3-2.	Test Method Comparison .....	3-12
4-1.	The Startup Menu.....	4-10
4-2.	The PMU Connection Configuration Screen .....	4-12
4-3.	PMU Phase Order Screen.....	4-15
5-1.	Setup Automated Test Window .....	5-8
6-1.	The Test Configuration Screen .....	6-4
6-2.	General Test Parameters.....	6-6
6-3.	Steady State Test Configuration Screen.....	6-9
6-4.	Frequency Ramp Test Configuration Screen .....	6-11
6-5.	Modulation Test .....	6-13
6-6.	Modulation Test Configuration Screen .....	6-15
7-1.	Iterative Graph Configuration Window .....	7-5
8-1.	Flule Calibration Service Centers .....	8-10
9-1.	Oscilloscope Settings .....	9-3
9-2.	Time Differences.....	9-4
9-3.	Oscilloscope Setup .....	9-5
9-4.	Trigger Values.....	9-6



# List of Figures

Figure	Title	Page
1-1.	The 6135A/PMU Calibration System .....	1-4
1-2.	The Calibration System .....	1-10
1-3.	The Calibration System Connections .....	1-11
1-4.	The 6135A System and Phases .....	1-15
1-5.	The Monitor Screen .....	1-20
2-2.	Ethernet Connections .....	2-10
2-3.	First Time Setup .....	2-17
2-4.	Test File Selection .....	2-19
3-2.	The Calibration Process .....	3-4
3-3.	Accuracy Requirements (Illustration) .....	3-5
3-4.	Synchrophasor Angles .....	3-6
3-5.	Simplified Block Diagram of the 6135A/PMUCAL .....	3-7
3-6.	UUT Personality Screen .....	3-9
3-7.	UUT Personality Profile Screen .....	3-10
3-8.	UUT Personality Profile .....	3-11
3-10.	Automated Test Sequence .....	3-14
3-11.	Custom Interactive Testing Window .....	3-15
3-12.	Test Configuration Window .....	3-16
3-13.	Test Progress Screen .....	3-16
3-14.	Graph Configuration Window .....	3-17
3-15.	The Interactive Graph Screen .....	3-18
3-16.	Mode of Operation Indicator .....	3-18
3-17.	Default Test File Structure .....	3-20
3-18.	Steady State Compliance Sub-test Naming Convention .....	3-23
3-19.	Dynamic Compliance Subtest Naming Convention .....	3-24
3-20.	Latency Subtest Naming Convention .....	3-24
3-21.	Automated Test List Naming Convention .....	3-25
3-22.	Active Results File Path and File .....	3-25
3-23.	Example Test Results .....	3-26
3-24.	Master Test Results File Naming Convention .....	3-27
3-25.	Results File Selection Window .....	3-28
3-26.	Test Results File Storage Directory .....	3-28
4-1.	UUT Connection Procedure .....	4-5
4-2.	Current Connections (Three Sets of Current Shown) .....	4-6
4-3.	Voltage Connections (Three Sets of Voltage Shown) .....	4-7

4-4.	The UUT and Server PC Network Cable Connections .....	4-8
4-5.	Calibrator GPS Connection .....	4-8
4-6.	Test Menu .....	4-16
4-7.	Plot .....	4-17
4-8.	Voltage Phases Correct .....	4-18
4-9.	Problem - Voltage Phases Swapped .....	4-19
4-10.	Problem - Voltage Phase B is Not Connected .....	4-20
4-11.	Current Phases Correct .....	4-21
4-12.	Problem - All Outputs Forced Off .....	4-22
5-1.	Load Automated Test .....	5-4
5-3.	Results File Selection .....	5-5
5-3.	Test Status Window .....	5-5
5-4.	Load Results File Dialog Box .....	5-6
5-5.	Test Status .....	5-7
6-1.	Test Type Selection .....	6-7
7-1.	Interactive Graph Example .....	7-3
7-2.	Interactive Graph Window Information .....	7-4
7-3.	Example Graph Configuration (One Source, One Input) .....	7-7
7-4.	Example Interactive Graph Configuration (Two Sources, One Input) .....	7-7
7-5.	Example Graph Configuration .....	7-8
7-6.	Example Interactive Graph Configuration .....	7-9
7-7.	Example Vertical or Horizontal Zoom .....	7-10
7-8.	Example Quadrant Zoom-in .....	7-11
7-9.	Undock and Dock a Panel .....	7-11
7-10.	Change the Data Displayed in the Panel .....	7-12
7-11.	Example Change the Look of a Plot .....	7-12
7-12.	The Test Results Viewer .....	7-13
7-13.	Test Log Example .....	7-14
7-14.	Template Selection .....	7-16
7-15.	List of Results .....	7-17
7-16.	Report Selection .....	7-18
7-17.	Example Report .....	7-20
8-1.	System Connections .....	8-3
9-1.	Illustration of Plot .....	9-6

# Chapter 1

## *Introduction and Specifications*

Title	Page
Introduction.....	1-3
About this Chapter .....	1-3
Standard Accessories .....	1-5
Safety Information .....	1-6
About the Manual Set .....	1-8
Contact Fluke Calibration .....	1-9
Performance Verification and Repair Information .....	1-9
Calibration System Overview .....	1-10
Components of the Calibration System .....	1-12
Client PC .....	1-12
Server PC.....	1-13
6135A Three Phase Power Standard .....	1-14
Symmetricom GPS Receiver .....	1-16
6135A/PMU System Timing Unit.....	1-17
6135A/PMU System Software Status Panel.....	1-19
PMUCal Software.....	1-20
Overview .....	1-20
Monitor Screen .....	1-20
Navigation Menu .....	1-21
The System Status Panel .....	1-22
General Specifications .....	1-23
Input Power .....	1-23
Dimensions .....	1-23
Environment .....	1-23
Standard and Agency Approvals .....	1-23
Electrical Source Accuracy Specifications .....	1-23
Performance Specifications for C37.118.1 Tests.....	1-23
PMU Test: Limits to Range of Influence Quantities .....	1-24
General Test limits .....	1-24
Steady State Tests.....	1-24
Modulation Tests .....	1-24
Frequency Ramp Tests .....	1-24
Input Step Change Tests.....	1-24





## Introduction

The Fluke Calibration 6135A/PMUCAL Phasor Measurement Unit Calibration System (the Product or Calibration System) is a measurement and calibration device used to calibrate and test a PMU (Phasor Measurement Unit).

Features of the Calibration System:

- Simulate static and dynamic conditions that a UUT can experience in a power grid.
- Test a UUT against the performance standards written in *IEEE C37.118.1- 2011 (Synchrophasor Measurements for Power Systems)* and *IEEE C37.118.2 (Synchrophasor Data Transfer for Power Systems)*.
- Quickly set up and configure a UUT for calibration with a single, side mounted input panel.
- Remotely calibrate and test a UUT from a desktop PC using the PMU Calibration Software.
- Manually run single tests or use the factory built-in automated test procedures.
- Produce formal calibration reports in a format that can be easily printed or shared electronically.

The Calibration System is made up of six individual devices that are interconnected inside a server rack (see Figure 1-1). See the “Components of the Calibration System” for more information about each individual device.

The Fluke 6105A and two 6106A together comprise a 6135A. The Fluke 6135A is a source of precision three phase voltage and current signals. These precise signals must be related to Universal Coordinated Time (UTC) to be useful for calibration of PMU UUTs. The 6135A/PMU System Timing Unit uses accurate time from the GPS receiver to align the 6135A output frequency and phase angles to meet the requirements of the PMU calibration standard: *IEEE C37.118.1 - 2011*.

A Client software application package on a laptop or desktop computer (not shown) lets the operator communicate with the Server PC via a WAN (wide area network) connection. The Server PC controls the equipment as required by calibration procedures located on the Client computer.

For an alphabetical list of terms and abbreviations used in this chapter and manual, see “The Glossary” in Appendix A of this manual.

## About this Chapter

This Chapter supplies information about the Calibration System. Read this Chapter before installing the Calibration System. For an alphabetical list of terms and abbreviations used in this chapter and manual, see “The Glossary” in Appendix A of this manual.

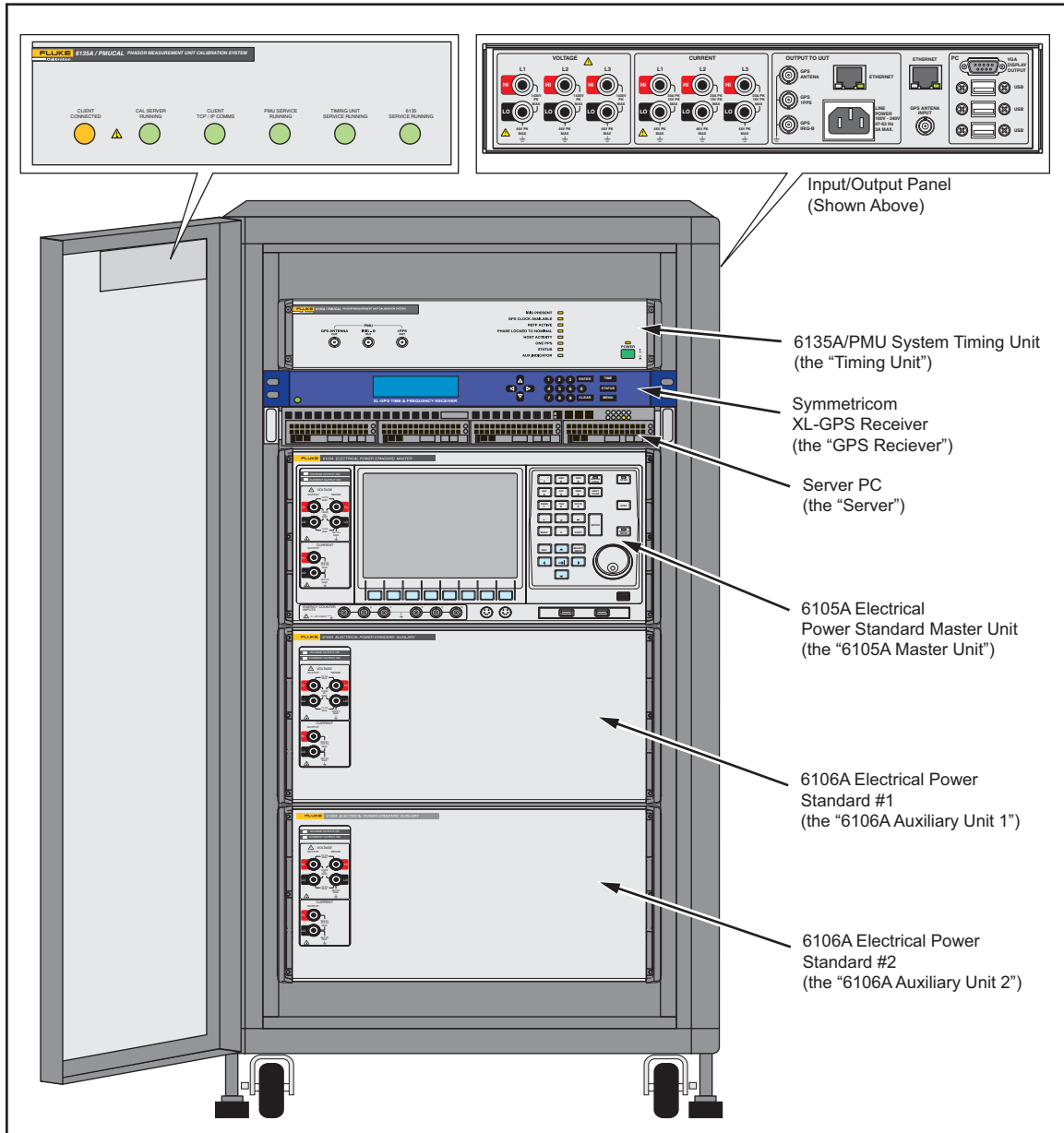

gtu009.eps

**Figure 1-1. The 6135A/PMU Calibration System**

## **Standard Accessories**

The Calibration System comes with items in Table 1-1. The accessories and manuals can be found in the boxes inside the shipment crate. To order replacement parts or accessories, contact Fluke Calibration and reference the part numbers and item names in Table 1-1.

**Table 1-1. Standard Equipment and Accessories**









Item	Part Number	Quantity
Printed Safety Information	3998483	1
CD-ROM with Calibration System software, Safety Information, and Operators Manual	3998490	1
Voltage and current leads kit (located in black bag)	1887637	3
CD-ROM disks with National Instruments interface drivers and Symmetricom XL-GPS Receiver drivers	Contact Fluke	2
Country dependent mains-power cords	Contact Fluke	3

## Safety Information

A **Warning** identifies condition and procedures that are dangerous to the user. A **Caution** identifies conditions and procedures that can cause damage to the Product or the equipment under test.

The symbols used in this manual and on the Calibration System are explained in Table 1-2

Table 1-2. Symbols

Symbol	Description	Symbol	Description
	Risk of danger. Important information. See manual.		DC (Direct Current)
	Hazardous voltage. Voltage >30 V dc or ac peak might be present.		AC or DC (Alternating or Direct Current)
	Power ON / OFF		Earth ground
	Conforms to relevant North American Safety Standards.		Product conforms with the requirements of the applicable EC directives.
	This product complies with the WEEE Directive (2002/96/EC) marking requirements. The affixed label indicates that you must not discard this electrical/electronic product in domestic household waste. Product Category: With reference to the equipment types in the WEEE Directive Annex I, this product is classed as category 9 "Monitoring and Control Instrumentation" product. Do not dispose of this product as unsorted municipal waste. Go to Fluke's website for recycling information.		

### Warning

**To prevent possible electrical shock, fire, or personal injury:**

- **Read all safety information before you use the Product.**
- **Use the Product only as specified, or the protection supplied by the Product can be compromised.**
- **Do not use the Product if it operates incorrectly.**
- **Do not use and disable the Product if it is damaged.**
- **Do not use test leads if they are damaged. Examine the test leads for damaged insulation, exposed metal, or if the wear indicator shows. Check test lead continuity.**
- **Use this Product indoors only.**
- **Do not use the Product around explosive gas, vapor, or in damp or wet environments.**
- **Use only the mains power cord and connector approved for the voltage and plug configuration in your country and rated for the Product.**
- **Replace the mains power cord if the insulation is damaged or if the insulation shows signs of wear.**

- **Carefully read all instructions.**
- **Do not connect to live output terminals. The Product can supply voltages that can cause death. Standby mode is not sufficient to prevent electrical shock.**
- **Do not touch voltages > 30 V ac rms, 42 V ac peak, or 60 V dc.**
- **Do not operate the Product with covers removed or the case open. Hazardous voltage exposure is possible.**
- **Disconnect the mains power cord before you remove the Product covers.**
- **Use only specified replacement fuses.**
- **Properly terminate the sense leads to prevent exposure to hazardous voltages on the sense terminals. The voltage sense terminals are at output voltage when the two-wire function is set.**
- **Do not touch exposed metal on banana plugs, they can have voltages that could cause death.**
- **Connect an approved three-conductor mains power cord to a grounded power outlet.**
- **Do not put the Product where access to the mains power cord is blocked.**
- **Do not use a two-conductor mains power cord unless you install a protective ground wire to the Product ground terminal before you operate the Product.**
- **Make sure that the Product is grounded before use.**
- **Do not use an extension cord or adapter plug.**
- **Make sure that the space around the Product meets minimum requirements.**
- **Have an approved technician repair the Product.**
- **The open space around the Product must not be less than 4 inches (100 mm) as described in the product installation instructions.**
- **Remove all three system input power cords from the Power Distribution Unit power inlets to isolate the mains for assembly and disassembly. Do not rely on the Power Distribution Unit secondary protection breakers to isolate the Product from the mains.**
- **Load and unload the Product from its transit case on a flat surface.**
- **Use two or more personnel to remove the Product from the crate.**

- **Do not try to lift the Product, it weighs approximately 150 kg (330 pounds).**
- **Lower the system feet when the Product is stationary.**
- **Connect the line power cord to the UUT before the line power cord to the Input/Output Panel line power outlet is connected.**
- **Disconnect L1, L2, and L3 voltage and current outputs from the Input/Output Panel before the signal connections to a UUT are connected or disconnected.**
- **Do not attempt to connect or disconnect any electrical connections to the UUT if the "Client Heartbeat" LED on the front of the Product is flashing Amber. This indicates the product is operating under remote control and outputs may have hazardous voltages present. Always treat the Input/Output Panel connectors, L1, L2, and L3, as if they have hazardous voltages.**
- **Make sure any exposed voltage connections on UUT are protected from accidental contact. There may be hazardous voltages present.**

### **About the Manual Set**

The Calibration System comes with an Operators Manual and Safety Information. These manuals are supplied on the CD and can be downloaded from Fluke Calibration's website at <http://us.flukecal.com/literature/manuals/search>.

This Operators Manual supplies all the information to safely unpack, install, configure, and use the Calibration System.

The Safety Information supplies safety information specific to the Calibration System and is translated into many languages.

This Operators Manual contains references to documents and specifications that are not included with the Calibration System. See Table 1-3 for the list of referenced manuals.

**Table 1-3. Referenced Manuals and Specifications**

<b>Document Number</b>	<b>Title</b>
6100B/6105A	Electrical Power Standards Users Manual
XL-GPS	Symmetricom XL-GPS User Guide
IEEE C37.118.1-2011	Synchrophasor Measurements for Power Systems Specification
IEEE C37.118.2	Synchrophasor Data Transfer for Power Systems Specification
IEEE C37.242	Guide for Synchronization, Calibration, Testing, and Installation of (PMU) for Power System Protection and Control Specification

## Contact Fluke Calibration

To contact Fluke, call one of the following telephone numbers:

- Technical Support USA: 1-877-355-3225
- Calibration/Repair USA: 1-877-355-3225
- Canada: 1-800-36-FLUKE (1-800-363-5853)
- Europe: +31-40-2675-200
- Japan: +81-3-6714-3114
- Singapore: +65-6799-5566
- China: +86-400-810-3435
- Brazil: +55-11-3759-7600
- Anywhere in the world: +1-425-446-6110

To see product information and download the latest manual supplements, visit Fluke Calibration's website at [www.flukecal.com](http://www.flukecal.com).

To register your product, visit <http://flukecal.com/register-product>.

## Performance Verification and Repair Information

Annual performance verification and adjustment is recommended to verify performance to the Calibration System specifications. Fluke Calibration is the only Service Center that can fully adjust and repair the Calibration System. If shipping the complete system is difficult, it might be more convenient to send just the 6135A Three Phase Power Standard to Fluke for calibration and verify the rest of the system with a few simple time measurements using an oscilloscope as instructed in Chapter 9. To schedule and send the Calibration System or just the 6135A Three Phase Power Standard to Fluke for calibration or repair:

1. Contact a Fluke Calibration Service Center and schedule the Calibration or repair.
2. Pack and secure the Calibration System in the shipping crate that Calibration System came in.
3. Send the Calibration System to one of the Service Centers in Table 1-4.

**Table 1-4. Fluke Calibration Service Centers**

Your Location	Shipping Address
North America	<b>Fluke Calibration Service Center</b> 1420 75th St. SW. Everett WA 98203
Europe	<b>Fluke Calibration Service Center</b> Fluke UK Ltd 52 Hurricane Way Norwich Norfolk, NR6 6JB United Kingdom

## Calibration System Overview

The Calibration System is a measurement and calibration device that calibrates and tests a PMU. The Calibration System simulates static and dynamic conditions that a UUT can experience in a power grid and can test a UUT against the performance standards written in *IEEE C37.118.1-2011 (Synchrophasor Measurements for Power Systems)* and *IEEE C37.118.2 (Synchrophasor Data Transfer for Power Systems)*.

The Calibration System is made up of six individual devices that are interconnected inside a server rack (see Figure 1-2). Figure 1-3 shows a system wiring schematic of how each device is interconnected. See “Components of the Calibration System” in this chapter for more information about each individual device.

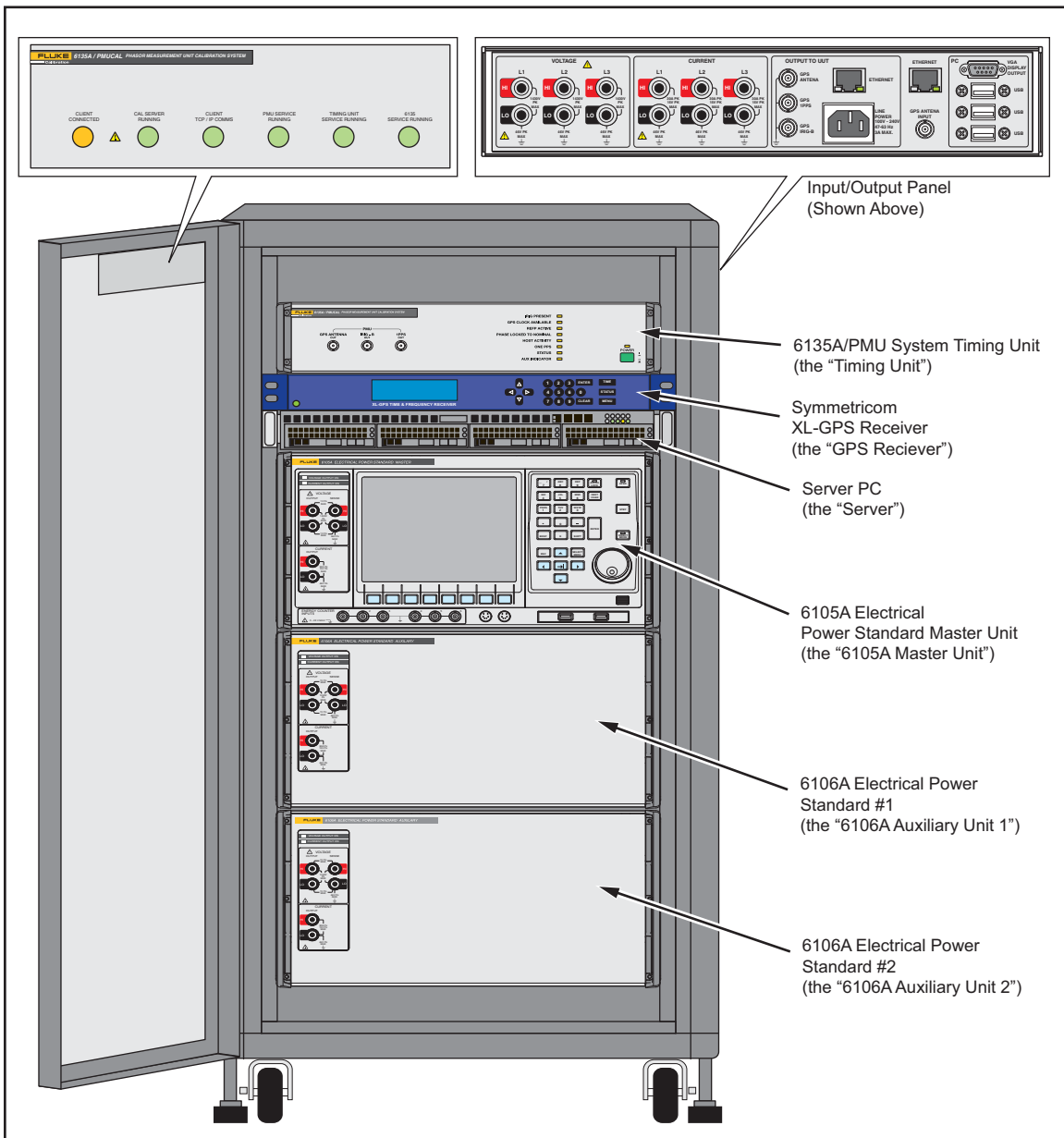
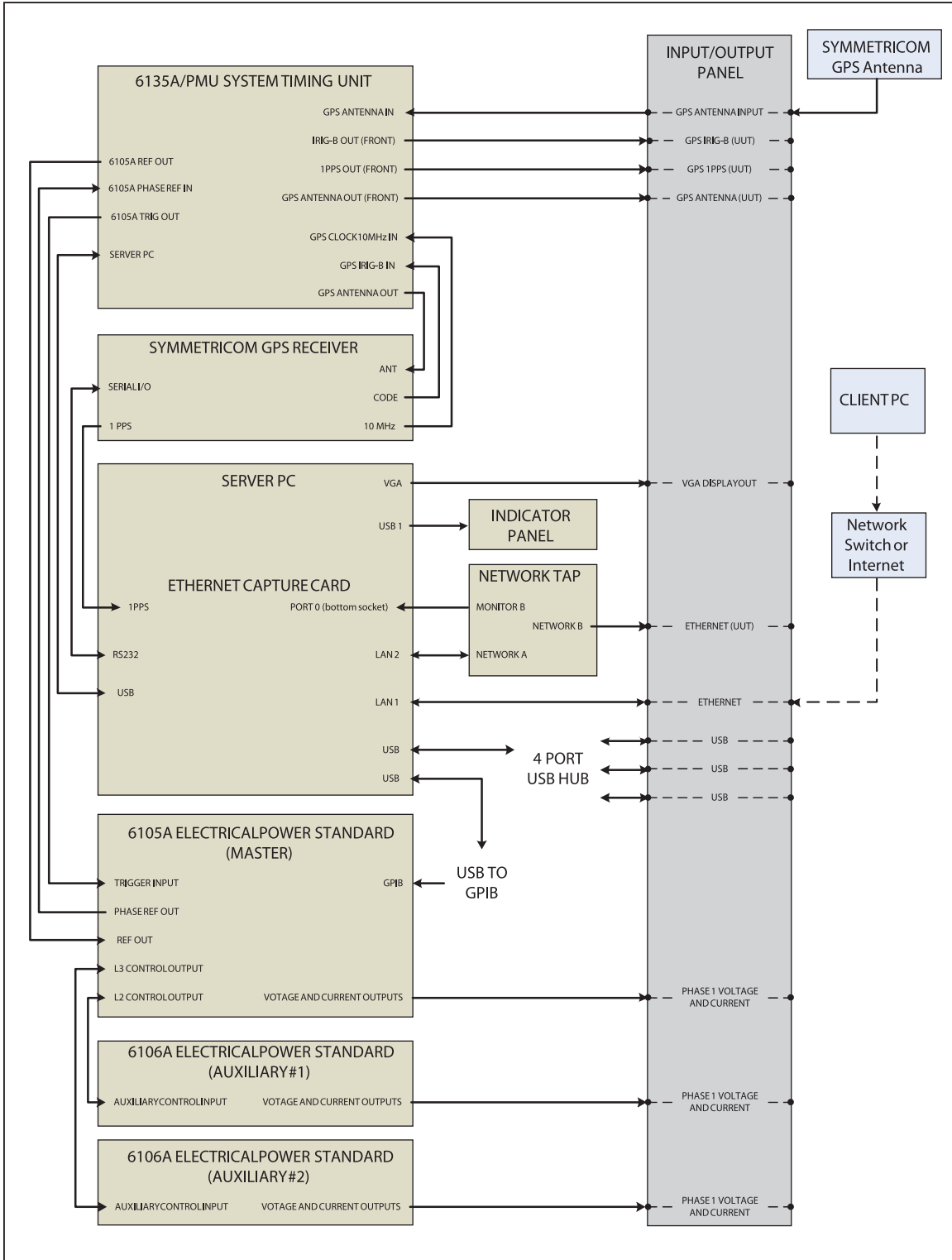

Figure 1-2. The Calibration System

gtu009.eps





gtu179.eps

Figure 1-3. The Calibration System Connections

## Components of the Calibration System

### Client PC

The Client PC is the personal computer used to operate the Calibration System.

*Note*

*The Client PC is not supplied with the Calibration System.*

The Client PC must meet the minimum requirements listed in Table 1-5 and have the Calibration Software installed (see “Install the Calibration Software” in Chapter 2).

The Client PC can be directly connected to the Server PC or network (see Figure 1-3). See Chapter 2 for instructions on how to set up a network or a direct connection.

To use the Client PC with the Calibration System, the Client PC must meet the minimum requirements in Table 1-5.

**Table 1-5. Client PC Minimum Requirements**

PC Component	Minimum Requirement	Additional Information
Operating System	Microsoft Windows 7	-
Processor Speed	2 GHz	-
Memory (RAM)	4 GB	-
Hard Drive Free Space	500 GB	Report data is stored on the Client PC Over time some results data may need to be copied to an archive and removed to ensure the Client PC has sufficient free space.
Network Connection	Bandwidth of 300 KB a second	-
DVD Drive	32X Speed	Used to install the Calibration Software.
Microsoft Excel	2010 or newer	Used for test reports.

## Server PC

The Server PC (shown in Figure 1-6) is a server computer that receives commands from the Client PC and controls the Calibration System. The default settings made by Fluke at the time of shipping are:

- PC name: **PMUCal**
- ID Address: **192.168.0.250**

Network administrators can set up IP addresses to configure the Server PC to work on the network if necessary, but take note of the cautions listed below. To work on the Server PC, plug in a monitor, a mouse, and a keyboard into the Input Panel. Log on to the Server PC with:

- Username: **PMUCal**
- Password: **FlukeCal123**

### Caution

**To prevent damage to the Calibration System:**

- **Only use the Server PC for Calibration System operation.**
- **Anti-virus programs can disrupt or block Server/Client communications. Installation of these programs on the Server PC should be avoided if possible.**
- **Do not enable Windows automatic updates. The automatic updates feature can force a PC reboot at any time which could occur while the system is in operation. Periodically check for updates and perform a manual update.**
- **The Server PC should use a fixed IP address (static) and not use auto-allocation (dynamic).**
- **Do not change the configuration of the Server PC.**

When more than one Calibration System is connected to the same network, the IP addresses and Server PC names of at least one system must be changed so that each system has unique identification.

The Server PC connections are available at the Input/Output Panel on the side of the cabinet. See Table 1-6 .

Table 1-6. Server PC Connections

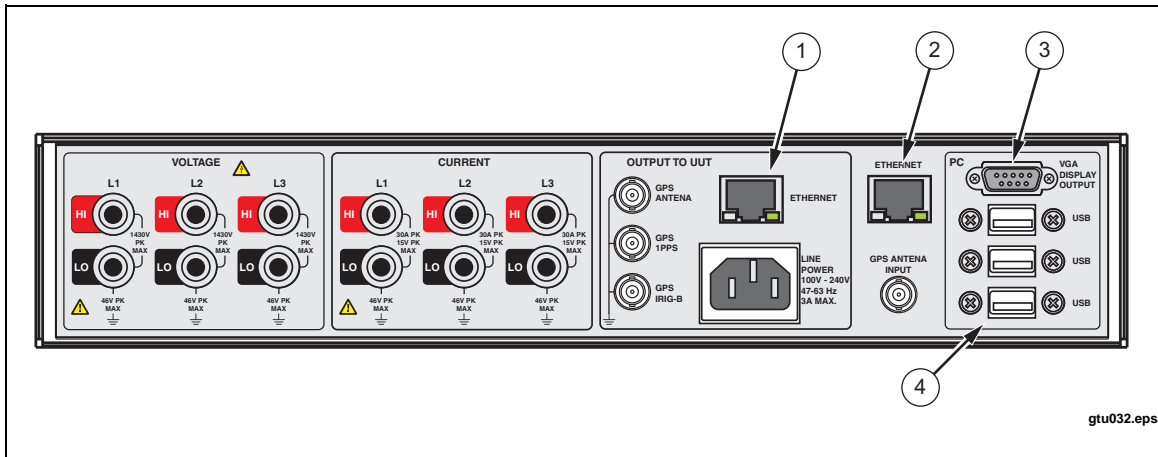

Item	Name	Description
①	ETHERNET (OUTPUT TO UUT)	Connect to the UUT.
②	ETHERNET	Connect to the local network.
③	VGA DISPLAY OUTPUT	Connect to a VGA monitor.
④	USB (x3)	Connect a keyboard and mouse to operate the Server PC.

**6135A Three Phase Power Standard**

The 6135A Three Phase System (the 6135A System) shown in Figure 1-4 supplies the Calibration System with three individual sources of ac voltage and current to the UUT. The 6135A System contains one 6105A Electrical Power Standard (L1) and two 6106A Electrical Power Standards (L2 and L3). The complete 6135A System is connected to and controlled by the 6135A/PMU System Timing Unit (the Timing Unit) and the Server PC (see Figure 1-3).

When the Calibration System is turned on, the Server PC automatically puts the 6135A System in remote mode. In remote mode, you cannot use the front-panel controls on the 6105A Master unit. It is possible to disconnect the 6135A System from the Calibration System to use it for applications other than UUT calibration.

The 6135A units are ordered by phase (see Figure 1-4). Connect the UUT to the Calibration System Input/Output Panel in this sequence to a prevent phase mismatch:

1. Phase A to L1
2. Phase B to L2
3. Phase C to L3

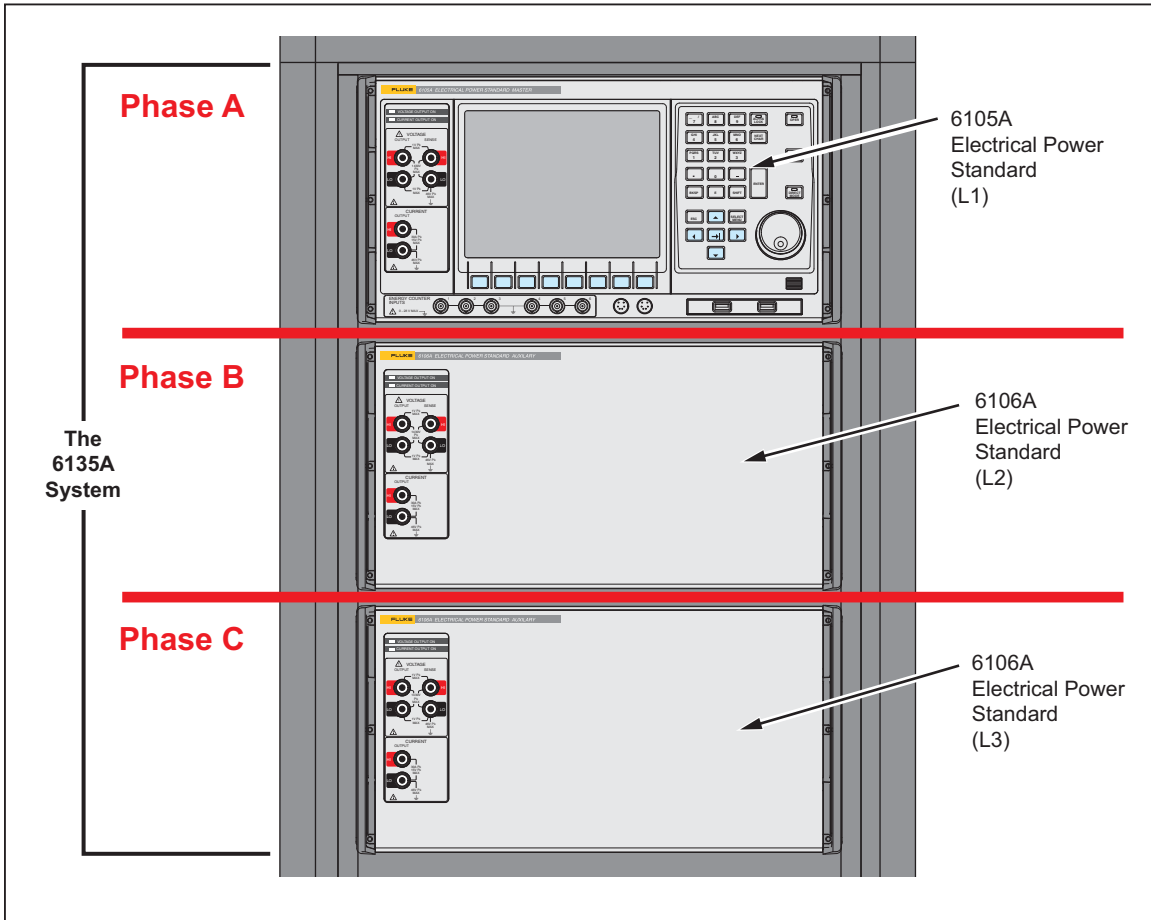

gtu102.eps

Figure 1-4. The 6135A System and Phases

The voltage and current outputs on the front panels of the 6135A System are connected to the Input/Output Panel.

**⚠ Caution**

**To prevent damage to the system or the UUT, do not manually adjust the controls on the front panel of the 6105A.**

The UUT is directly connected to the outputs on the Input/Output Panel as shown in Table 1-7. For instructions on how to connect a UUT to the 6135A System, see “Connect the Calibration System to a UUT” in Chapter 4.

Table 1-7. 6135A Connections

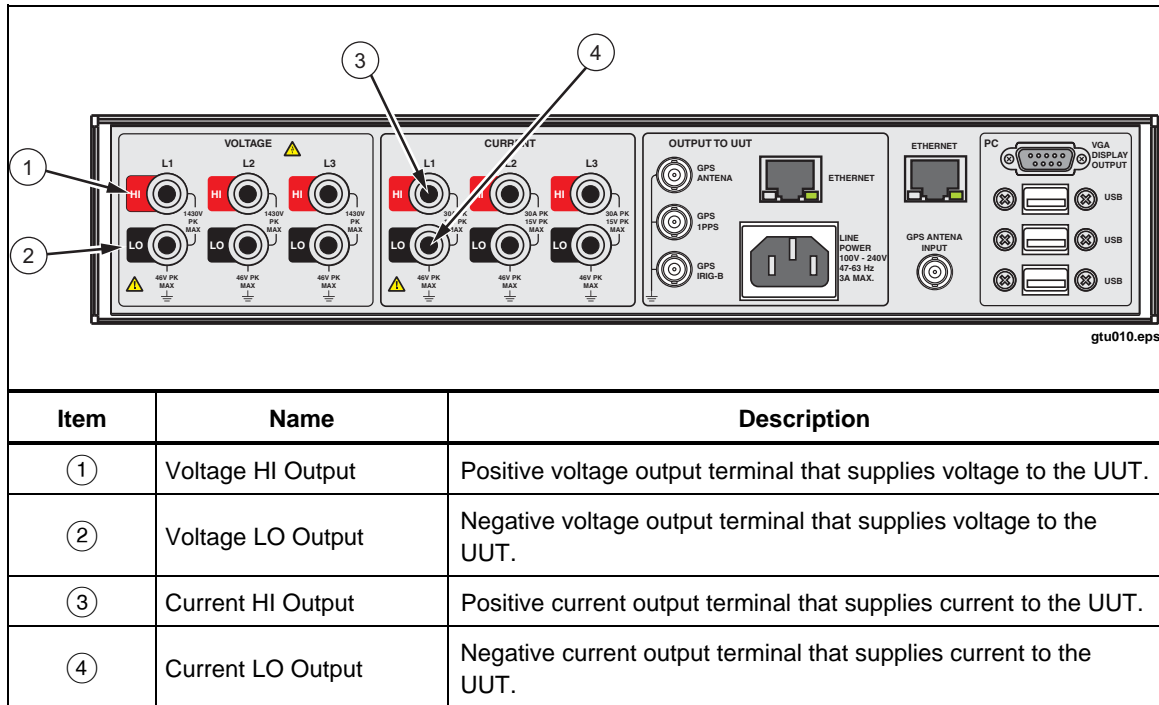

**Symmetricom GPS Receiver**

The Symmetricom XL-GPS Receiver (the GPS Receiver) shown in Table 1-8 supplies the Product and the UUT with a UTC (Universal Time Coordinated) time source. The UUT uses the time source to timestamp each report the UUT makes.

*Note*

*A GPS antenna must be installed in order to use the GPS Receiver. For installation instructions, see “Install the Calibration System” in Chapter 2.*

The GPS Receiver is connected directly to the Timing Unit. The Timing Unit is connected between the GPS receiver and the UUT. This lets the Timing Unit control the GPS signal to the UUT. The GPS time information is transmitted directly to the Calibrator through an IRIG-B connection on the rear panel. The Timing Unit and the GPS Receiver are kept in synchronization by a 10 MHz clock signal from the GPS Receiver.

When you turn-on the Calibration System, the GPS Receiver is configured to automatically lock onto satellites with a “good” signal indication. The Status Indicator LED and display text on the front of the GPS Receiver shows the communication status of GPS Receiver. See Table 1-8 for more information on the Status Indicator LED.

**Table 1-8. GPS Satellite Status Indicator LED**

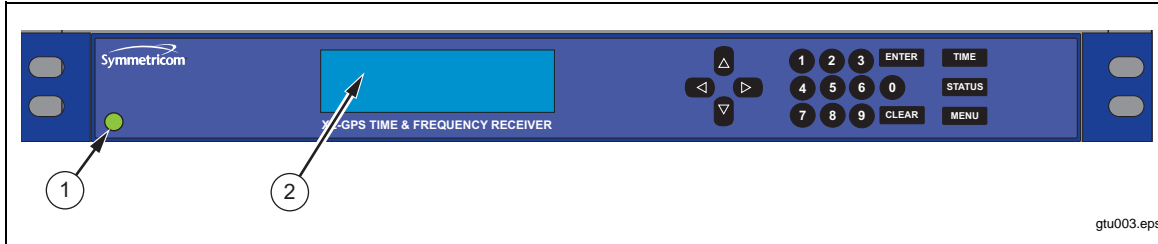

Item	Name	Light and Display Indications	Description
①	Satellite Lock Indicator	<p><b>FLASHING GREEN</b> = Satellite lock-on in progress.</p> <p><b>SOLID GREEN</b> = Locked on to four or more satellites.</p> <p><b>SOLID RED</b> = System cannot lock-on to a satellite. See “GPS Receiver” in Chapter 8.</p>	LED illuminates when the GPS Receiver is locked on to a satellite.
②	Locked Text	<p><b>Unlocked</b> = Not locked onto a satellite.</p> <p><b>Locked</b> = Locked on to four or more satellites.</p>	Text that shows the satellite connection status.

**6135A/PMU System Timing Unit**

The 6135A/PMU System Timing Unit (the Timing Unit) is the timing and modulation control device in the Calibration System. This device is connected to the Server PC, the 6135A System, the GPS Receiver, and the UUT (see Figure 1-3).

When you run a test, the PMUCal Software sends test parameters to the Server PC. The Server PC then transmits test parameters to the Timing Unit. The Timing Unit uses the UTC time signal from the GPS Receiver to precisely control the 6135A System output frequency, voltage, and current to the UUT.

The UUT is directly connected to the outputs on the Input/Output Panel as shown in Table 1-9.

**Table 1-9. The Timing Unit Connections**

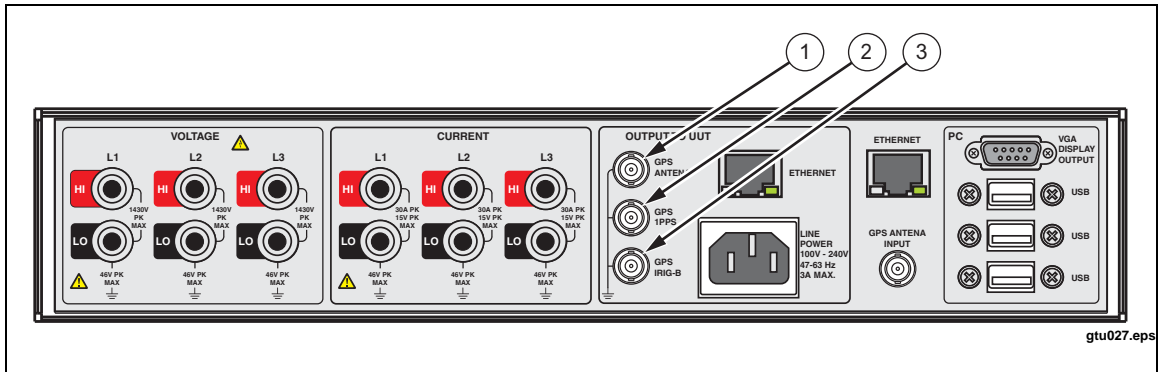

Item	Name	Description
①	GPS Antenna Out	GPS Antenna signal output to the UUT.
②	IRIG-B Out	IRIG-B GPS signal output to the UUT.
③	1PPS Out	1PPS signal output to the UUT. The signal is set to pulse on the UTC second from the GPS Receiver.

The Status Indicator LEDs on the front of the Timing Unit shows the communication status of Timing Unit and the equipment connected. See Table 1-10 for information on the Timing Unit Status Indicator LEDs.

**Table 1-10. Timing Unit Front-Panel Indicator LEDs**

<b>Name</b>	<b>LED Indications</b>	<b>Description</b>
IRIG Present	<b>On</b> = Connected to IRIG. <b>Off</b> = Not connected to IRIG.	LED illuminates when the Timing Unit senses an IRIG signal from the GPS Receiver.
GPS Clock Available	<b>On</b> = Connected to 10 MHz Clock. <b>Off</b> = Not connected to 10 MHz Clock.	LED illuminates when the Timing Unit senses a 10 MHz Clock signal from the GPS Receiver.
REFP Active	<b>On</b> = Connected to Phase Ref Input. <b>Off</b> = Not connected Phase Ref Input.	LED illuminates when the Timing Unit senses a Phase Ref Input from the 6135A System.
Phase Locked to Nominal	<b>On</b> = Locked to 1PPS Reference Signal. <b>Off</b> = Not locked to 1PPS Reference Signal.	LED illuminates when the Timing Unit is locked to the 1PPS reference signal from the GPS Receiver.
Host Activity	<b>Flashing</b> = Data transfer to Server PC. <b>Off</b> = No data transfer to Server PC.	LED is a visual indication of data sent between the Server PC and the Timing Unit. The Host Activity Indicator light will flash when data is sent or received.
One PPS	<b>Flashing</b> = Read UTC time OK. <b>Off</b> = Not reading UTC time.	LED is a UTC time visual that flashes on each UTC second.
Status	<b>On</b> = Calibrator OK. <b>Off</b> = Calibrator not on or not OK.	LED is a visual indication of the Calibration Systems status. If the Timing Unit is functional, the light will flash in a simulated "heartbeat" pattern. If the light is solid on or off and not flashing, this could be an indication that your system has malfunctioned. Refer to the troubleshooting chapter in this manual for more information.
AUX Indicator	<b>Flashing</b> = Lost connection to Server PC. <b>On</b> = Unit is in Manufacturing Test Mode (factory use only).	LED is a visual indicator that shows if the Timing Unit has lost connection to the Server PC. This LED is used for troubleshooting.



## 6135A/PMU System Software Status Panel

The 6135A/PMU System Software Status Panel (the Status Panel) is located on the system cabinet door and indicates which software services are active. Table 1-11 shows the Status Panel and describes the indicators.

**Table 1-11. System Software Status Panel**

Item	Name	Description
①	Client Connected	Flashes Amber twice a second to show when a Client PC is connected.  <b>⚠️⚠️ Warning</b> <b>To prevent injury and unexpected exposure to hazardous voltage, do not touch or expose any voltage conductors when the Client Connected light is flashing.</b>
②	Cal Server Running:	Flashes once a second to show that the Server is running. The indicator flashes regardless of Client connection status.
③	Client TCP/IP	Illuminates when the Client software sends commands during Client start-up. Client TCP/IP is normally in the off state.
④	PMU Service Running	Shows the status of the PMU Service loop running on the Server. It should illuminate once the Client software connects to the Server. Once illuminated, this indicator should remain illuminated while the Client application is running.
⑤	Timing Unit Service Running	Shows the status of the System Timing Unit Service loop running on the Server. It will be illuminated while the Client software is connected to the Server.
⑥	6135 Service Running	Shows the status of the 6135 Service loop running on the Server. It will be illuminated while the Client software is connected to the Server.

## PMUCal Software

### Overview

The PMUCal Software is the control interface to the Calibration System to test and calibrate a UUT. The PMUCal Software is a program that is installed the Client PC. Read the subsequent sections to learn about the basic menus and indicators of the PMUCal Software.

### Monitor Screen

The Monitor screen (Figure 1-5) is a default startup screen and shows error messages and log messages. The Calibration Software has a navigation menu on the top and a system status panel on the right. See Table 1-12 and Table 1-13 for more information on the navigation menu and system status panel.

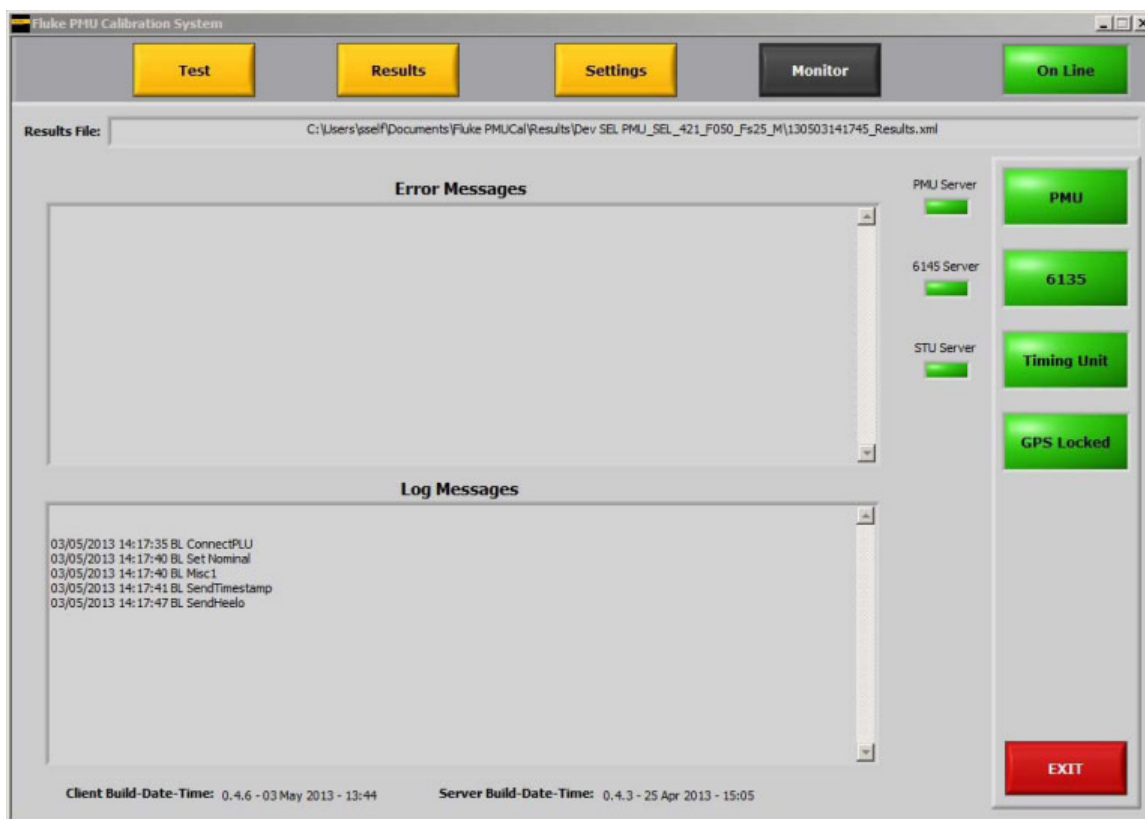







Figure 1-5. The Monitor Screen

gtu013.jpg

**Navigation Menu**

The navigation menu supplies you with all the buttons necessary to navigate the Calibration Software. See Table 1-12 for detailed information on each button in the navigation menu.





**Table 1-12. The Navigation Menu**

Button Name	Description
	Navigates to the test menu screen to run a test.
	Navigates to the results screen to view test results.
	Navigates to a menu screen that has configuration settings for UUT personalities, startup, folder and file locations, and data to retain.
	Navigates to the monitor screen that displays debugging and troubleshooting information.
Mode of Operation Indicator	<p>Shows the current Mode of Operation. The mode name appears above the indicator light. There are two modes of operation indicators (refer to “Calibration Software Modes of Operation” in Chapter 4 for more information on each mode):</p> <ul style="list-style-type: none"> <li> <b>Simulate Mode</b> – When in Simulation Mode, the name Simulate is shown above the indicator. The indicator is always illuminated green when in Simulation Mode.                             <div style="text-align: center;">  </div> </li> <li> <b>UUT Test Mode</b> – When in UUT Test Mode, the name OnLine is shown above the indicator. The indicator will only be illuminated green when all three system status indicators are green (see Table 1-13).                             <div style="text-align: center;">  </div> </li> </ul>

### The System Status Panel

The system status panel a single source of system status information. See Table 1-13 for more information on each indicator in the system status panel.

**Table 1-13. The System Status Panel**

Indicator Name	Description
 A green rectangular button with the text "PMU" in black.	Illuminates when the Client PC receives UUT data from the Server PC.
 A green rectangular button with the text "6135" in black.	Illuminates when the Client PC connects to the 6135A System through the Server PC. Flashes when the 6105 is being configured for a test run.
 A green rectangular button with the text "Timing Unit" in black.	Illuminates when the Client PC connects to the 6135A/PMU System Timing Unit through the Server PC.
 A green rectangular button with the text "GPS Locked" in black.	Illuminates when the Client PC cannot connect to the GPS receiver through the Server PC.
 A yellow rectangular button with the text "GPS Unlocked" in black.	Illuminates when the GPS receiver has failed to lock or has lost lock.

## General Specifications

### Input Power

Voltage .....	100 V to 240 V with up to ±10 % fluctuations
Frequency .....	47 Hz to 63 Hz
Maximum consumption .....	3,500 VA Max

### Dimensions

<b>Size</b>	
Height .....	1,170 mm (46 in)
Width .....	600 mm (24 in)
Depth .....	800 mm (32 in)
<b>Weight</b> .....	170 kg (374 lb)
<b>Weight in shipment crate</b> .....	210 kg (462 lb)

### Environment

<b>Warm-Up Time</b> .....	1 hour
<b>Temperature and Performance</b>	
Operating .....	5 °C to 35 °C
Storage .....	0 °C to 50 °C
Transit temperature range .....	0 °C to 50 °C. Transit outside this temperature range (-20 °C to 0 °C, or 50 °C to 60 °C) must be limited to <100 hours

### Relative Humidity

Operating .....	<80 % 5 °C to 30 °C ramping down linearly to 50 % at 35 °C
Storage .....	<95 %, non-condensing 0 °C to 50 °C

**Operating Altitude**..... 0 m to 2,000 m

**Storage Altitude** ..... 0 m to 12,000 m

### Standard and Agency Approvals

**Safety** ..... Complies with IEC 61010-1, Overvoltage Category II, Pollution degree 2

**EM/RFI/EMC**..... IEC 61326-1: Controlled EM Environments, FCC part 15 sub-part B class A

## Electrical Source Accuracy Specifications

See specifications in the 6100B/6105A Users Manual.

## Performance Specifications for C37.118.1 Tests

Parameter	TVE (%)	FE (Hz)	RFE (Hz/s)
Steady State	0.1	0.0005	0.001
Dynamic, Modulation	0.03	0.001	0.02
Dynamic, Ramp	0.1	0.0005	0.01

Parameter	Delay Time (s)
Step Time Accuracy	0.0002
Measurement reporting latency test accuracy (s)	0.00005
THD of fundamental (% of setting)	0.02

## PMU Test: Limits to Range of Influence Quantities

### General Test limits

Influence Quantity	Range (voltage)	Range (current)
PMU Nominal Frequency	50 Hz or 60 Hz	50 Hz or 60 Hz
PMU Nominal Magnitude	10 V to 240 V	0 A to 10 A
Signal Magnitude (percent of PMU nominal)	10 % to 120 %	10 % to 200 %
Signal Frequency Range	44.0 Hz to 65.9 Hz	44.0 Hz to 65.9 Hz
Test Duration (single test)	1 to 65535 seconds	1 to 65535 seconds

### Steady State Tests

Influence Quantity	Range
Phase Angle	$\pm 180^\circ$
Harmonic Distortion - Harmonic order <sup>[1]</sup>	2 to 100
Harmonic Distortion - Harmonic index <sup>[2]</sup>	0 % to 40 %
Out-of-Band Interference Frequency	5 Hz to 180 Hz
Out-of-Band Interference Magnitude (percent of PMU nominal voltage) <sup>[3]</sup>	0 % to 40 %

Notes:  
 [1] - Maximum harmonic frequency is 6 kHz.  
 [2] - Within the 6135A Amplitude / Frequency profile limits. See the the 6100B/6105A user's manual for details.  
 [3] - Limited to 30 % of 6135A range setting. See the 6100B/6105A user's manual for details.

### Modulation Tests

Influence Quantity	Range
Signal Magnitude	100 % of PMU nominal voltage / current
Signal Phase Angle	$\pm 180^\circ$
Modulation Frequency	0.1 Hz to 12 Hz
Amplitude Modulation Index	0 to 0.1
Phase Modulation Index (radians)	0 to 0.1 radians
Settling Time	0 to 10 seconds

### Frequency Ramp Tests

Influence Quantity	Range
Signal Magnitude	100% of PMU nominal voltage / current
Frequency Ramp	44.0 Hz to 65.9 Hz
Ramp Rate	0.1 Hz/s to 6 Hz/s
Phase shift	$\pm 180^\circ$
Transition Time	0 to 255 reports

### Input Step Change Tests

Influence Quantity	Range
Signal Magnitude	100% of PMU nominal voltage / current
Frequency	44.0 Hz to 65.9 Hz
Phase Shift	$\pm 180^\circ$
Phase Step Magnitude	$0^\circ$ to $\pm 180^\circ$
Amplitude Step Magnitude <sup>[1]</sup>	0 to $\pm 50\%$
Delay Before Step	255 seconds
Number of Steps <sup>[2]</sup>	1 to 40

Notes:  
 [1] - Positive amplitude step cannot exceed the 6135A range limit. See the 6100B/6105A Users Manual for details.  
 [2] - PMU response and delay times are small relative to PMU reporting intervals so multiple steps are staggered to increase the resolution of the measurement.

# **Chapter 2**

## ***Installation Instructions***

<b>Title</b>	<b>Page</b>
About this Chapter .....	2-3
Unpack and Inspect.....	2-3
Install the Calibration System.....	2-4
Pre-Installation Preparation .....	2-4
Installation Procedure .....	2-5
Install the PMUCal Software .....	2-5
Configure the Client PC.....	2-6
Configure Windows Firewall .....	2-6
Network Connection Instructions.....	2-10
Direct Connection Instructions.....	2-11
Set Up the File Storage Directory.....	2-17
Install the Test Files.....	2-19





## About this Chapter

This chapter contains information on how to safely install and configure the Calibration System. To become familiar with the Calibration System, read Chapter 1 before installation begins. For an alphabetical list of terms and abbreviations used in this chapter and manual, see “The Glossary” in Appendix A of this manual.

## Unpack and Inspect

The Calibration System is shipped in a wood shipment crate. Use the shipment crate to transport or ship the calibrator to Fluke Calibration for adjustment or repair.

### Note

*After the Calibration System is removed from the crate, store the crate in a dry, safe area for future use.*

To unpack, put the crate in a flat, level area with sufficient room to lower the crate ramp and maneuver the Calibration System. Visually examine the crate for shipment damage indications.

### Note

*If the crate has visible shipment damage, do not open the crate. Photograph the damage and contact the shipment company and Fluke (refer to “Contact Fluke Calibration” in Chapter 1).*

To unpack the Calibration System:

1. Unfasten the door to the shipment crate.
2. Remove the door from the shipment crate.
3. Set the door upside down on the ground to use as a ramp.
4. Remove the wooden braces.
5. Inspect system cabinet for shipment damage and ensure that the cabinet door is secure.

### **⚠ Warning**

**The Calibration System weighs approximately 170 kg (375 lb). To prevent personal injury or damage to the Calibration System use two or more people to move the Calibration System out of the crate and slowly down the ramp.**

### Note

*The tight packaging inside the shipment crate can make it hard to move the Calibration System out of the crate. The bottom frame on the front of the Calibration System is a good location to hold and pull.*

6. Visually examine the Calibration System for damage.
7. Remove and open the three accessory boxes found in the top shelf inside the shipment crate.
8. Examine to make sure all the standard accessories in Table 1-1 are in your accessories kit.
9. Reassemble the shipment crate.
10. Store the shipment crate in a safe area for future use.

## Install the Calibration System

This section supplies information on how to install the Calibration System. Use this section for the initial installation and also when the Calibration System comes back from annual adjustment or repair.

### Pre-Installation Preparation

Placement preparation is important for a successful Calibration System installation. The Calibration System needs to have access to three independent power outlets, a roof mounted GPS antenna, and a network connection for remote operation. Use the considerations in this section to help determine where to put the Calibration System.

#### Electrical Considerations:

- The maximum total power requirement for the Product is approximately 3500 VA. Three power cords are provided to share the load of the Product between three standard power outlets. Refer to the “General Specifications” section of this manual for input power requirements.
- The Calibration System must have a grounded power supply.
- The central earth connection for the equipment in the system is located in the bottom rear of the cabinet which is connected to earth via a connection on the Power Distribution Unit (PDU) and the power cords.
- The equipment in the cabinet and the PMU being tested are powered by the PDU in the rear of the cabinet. The equipment within the cabinet and the PMU being tested are protected by resettable breakers in the PDU.

#### Environmental Considerations:

Refer to the “General Specifications” section of this manual for environmental condition limits.

#### Cooling Considerations:

Product must be located at least 4 inches (100 mm) away from any objects that could restrict air flow. Make sure that the intake air to the Product is within the operating temperature limits in the environmental specification.

#### Caution

**To prevent damage to the Product from overheating, make sure the space around the Product is not less than 4 inches (100 mm).**

#### *Note*

*Do not put or store objects on top of the Calibration System as the top of the server rack can become very warm.*

#### Other Considerations:

The Calibration System needs to connect to a separate PC to operate. Install the Calibration System in an area where there is direct access to a PC or a network connection.

For first time installations:

1. Install the Symmetricom roof mounted GPS Antenna. For instructions, refer to the Symmetricom XL-GPS Users Guide.
2. Connect the GPS Antenna cable from the GPS Antenna to where the Calibration System is to be located. For instructions, refer to the Symmetricom XL-GPS Users Guide.

### **Installation Procedure**

After the Calibration System has been unpacked and the pre-installation is complete, install the Calibration System as follows:

1. Carefully move the Calibration System to the installation location.
2. Lower the system feet to prevent Product movement.
3. Open the rear server cabinet door.
4. Route the mains power cords through the top or bottom removable entry holes of the server cabinet and plug them into the power distribution unit.
5. Close the rear server cabinet door.
6. Connect the GPS Antenna cable to the GPS ANTENNA INPUT on the Calibration System Input/Output panel.
7. Continue to the “Install the PMUCal Software” section in this chapter for instructions on how to install the Calibration Software.

### **Install the PMUCal Software**

The Calibration is operated by a software program (PMUCal Software) that must be installed on a PC (the Client PC). For more information and a list of minimum requirements, see “Client PC” in Chapter 1.

To install the PMUCal Software:

1. Put PMUCal Software installation disk into the DVD drive in the Client PC.

*Note*

*The Calibration Software installation program should automatically open (auto-play) after the DVD has been put into the DVD drive. If it the program does not open, launch Windows Explorer and view the contents of the DVD drive. Find and run the ClientInstaller.bat file.*

2. Set the installation destination for the PMUCal Software and the National Instruments Software (see Figure 2-1).
3. Click **Next >>**.

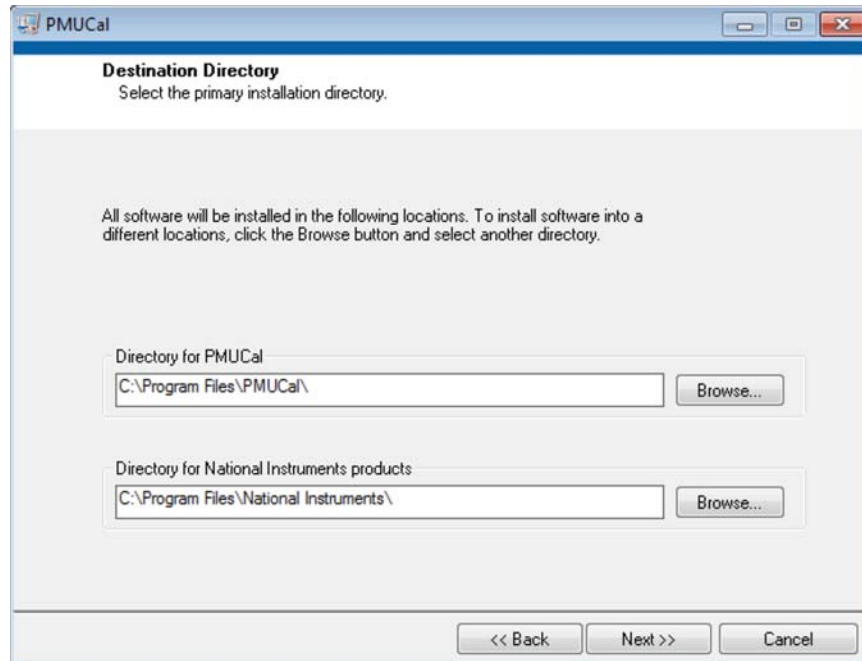

gtu044.jpg

Figure 2-1. Installation Destination Directory Screen

1. Read the **License Agreements** and click **Accept** or **Decline**.
2. Click **Next >>** to start the installation.
3. Click **Finish** to exit the installation software.
4. Click **Restart** to restart your computer.
5. Continue to the subsequent sections to configure the Calibration Software.

## **Configure the Client PC**

### **Configure Windows Firewall**

Before the Client PC can connect to the Calibration System, the Calibration Software program must be authorized to communicate through the Windows firewall as follows:

1. Open the **Windows Start Menu** and type **windows firewall** in the search box. Push Enter on your keyboard or click on the Network and Sharing Center link.

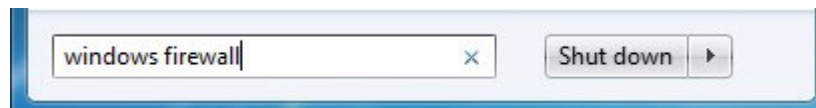

gtu160.jpg

2. Click **Allow a Program or Feature through Windows Firewall**.

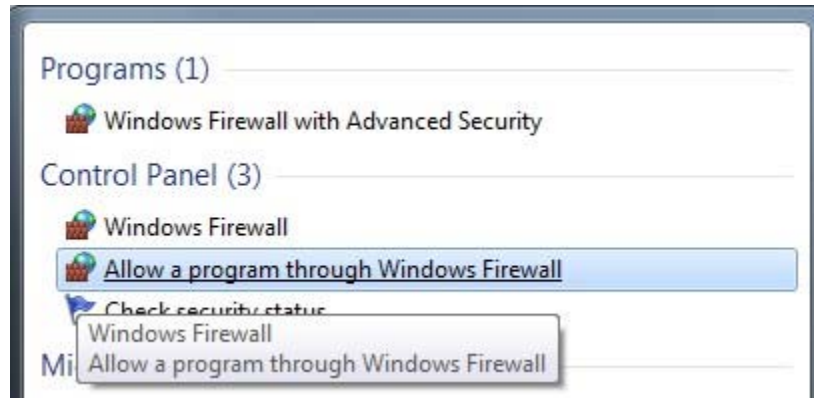

gtu161.jpg

3. On the Allowed Programs window, click **Change settings** (if button is enabled).

### Allow programs to communicate through Windows Firewall

To add, change, or remove allowed programs and ports, click Change settings.

What are the risks of allowing a program to communicate?

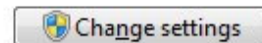

**i** For your security, some settings are managed by your system administrator.

Allowed programs and features:

Name	Domain	Home/Work (Pri...	Public	Group Policy

gtu162.jpg

4. Click **Allow another program....**

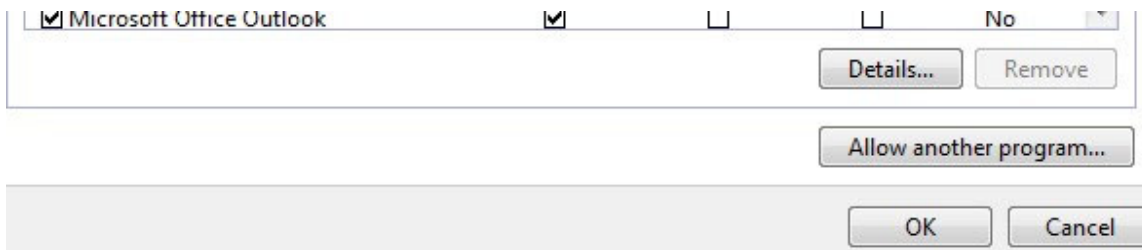

gtu163.jpg

5. Select **PMUCalClient** from the list.

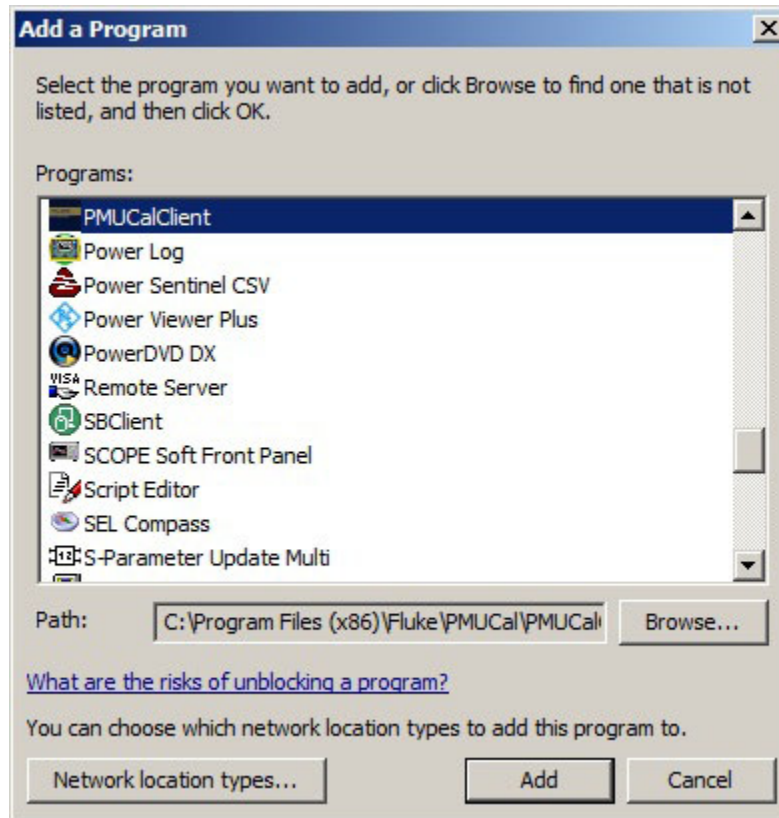

gtu164.jpg

6. Click **Add**.

7. Scroll down to **PMUCalClient** and make sure all check boxes are checked.

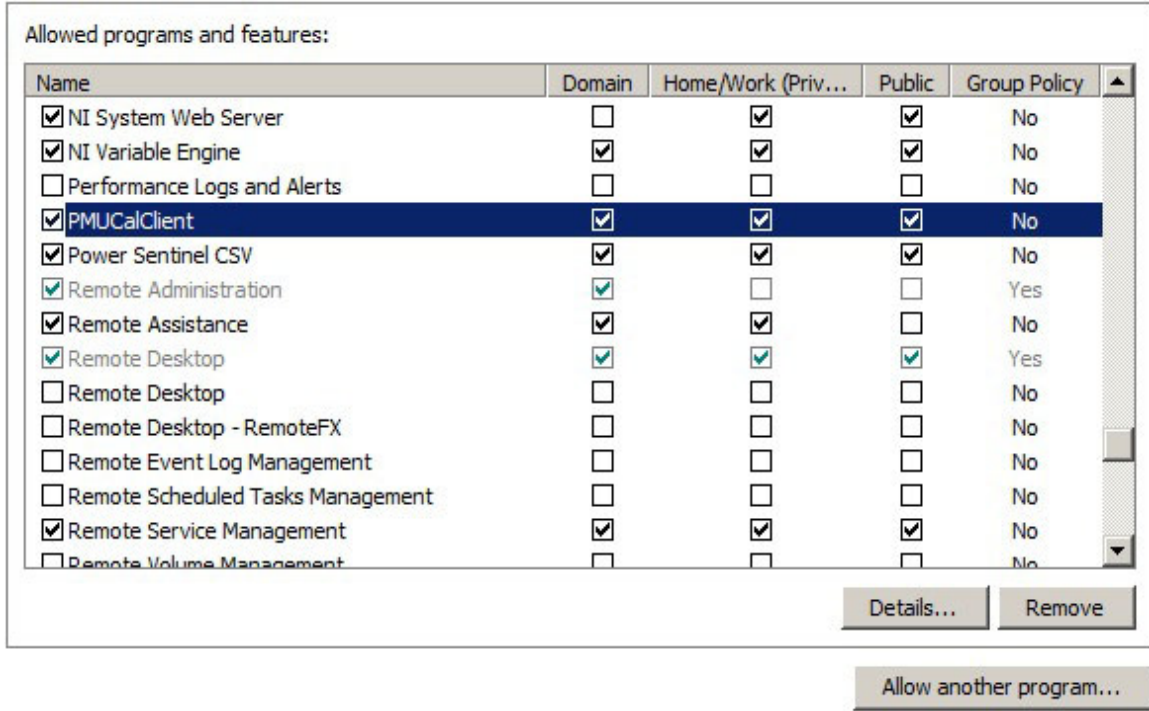

gtu165.jpg

*Note*

*The Domain column only shows if the PC is connected to a network that is part of a domain.*

8. Click **OK**.
9. Restart the Client PC.
10. Use the instructions in the subsequent sections to make a network or a direct PC connection.

## Network Connection Instructions

The Client PC and the Calibration System can be connected to a network. If a network is not available, use the instructions in the “Direct Connection Instructions” section to make a PC to PC connection.

Connect the Calibration System to the network using a standard Category 5 (CAT-5) straight-through Ethernet cable to the Input/Output Panel Ethernet connector (above GPS antenna connection).

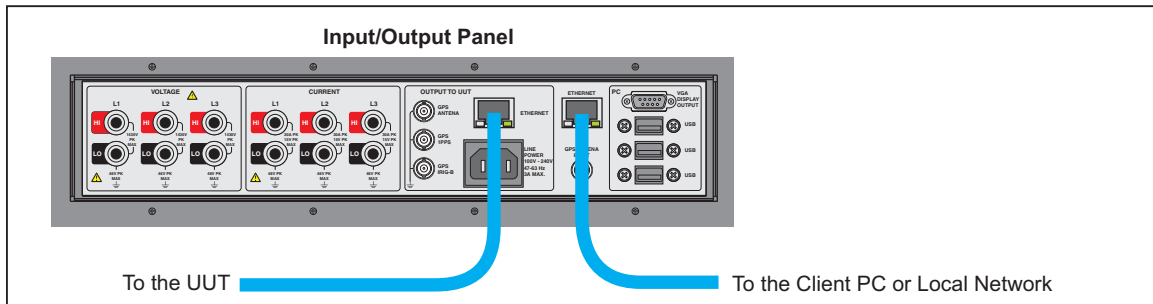

Figure 2-2. Ethernet Connections

gtu141.eps

Set up a network connection to the Calibration System as follows:

1. Connect the Client PC to the network if necessary.
2. Connect the Calibration System Ethernet connection to the LAN. To do this, connect one side of an Ethernet cable to right most Ethernet Port on the Input/Output Panel as shown in Figure 2-2. Connect the other end to a network access point.
3. Use the instructions in Chapter 4 to connect to a UUT.



**Direct Connection Instructions**

When a network is not available, the Calibration System can be connected directly to a PC.

To set up a direct connection:

1. Connect the Client PC directly to the Server PC. To do this, connect one end of an Ethernet cable to right most Ethernet port on the Input/Output Panel. Connect the other end of the cable to the Client PC the as shown in Figure 2-2.
2. Turn on the Calibration System (see “Turn On the Calibration System” in Chapter 4).
3. On the Client PC, assign the IP address of the Calibration System as follows:
  - a. Open the **Windows Start Menu** and type “**network and sharing**” in the search box.



gtu166.jpg

- b. Click **Network and Sharing Center**.



gtu167.jpg

- c. On the Network and Sharing Center menu, click **Change Adapter Settings**. The Network Adapter menu opens.



gtu168.jpg

- d. On the Network Adapter menu, right-click on the **Local Adapter** and then select **Properties** from the list.



gtu169.jpg

- e. On the Local Area Connection Properties menu, highlight **Internet Protocol Version 4 (TCP/IPv4)** then click the **Properties** button.

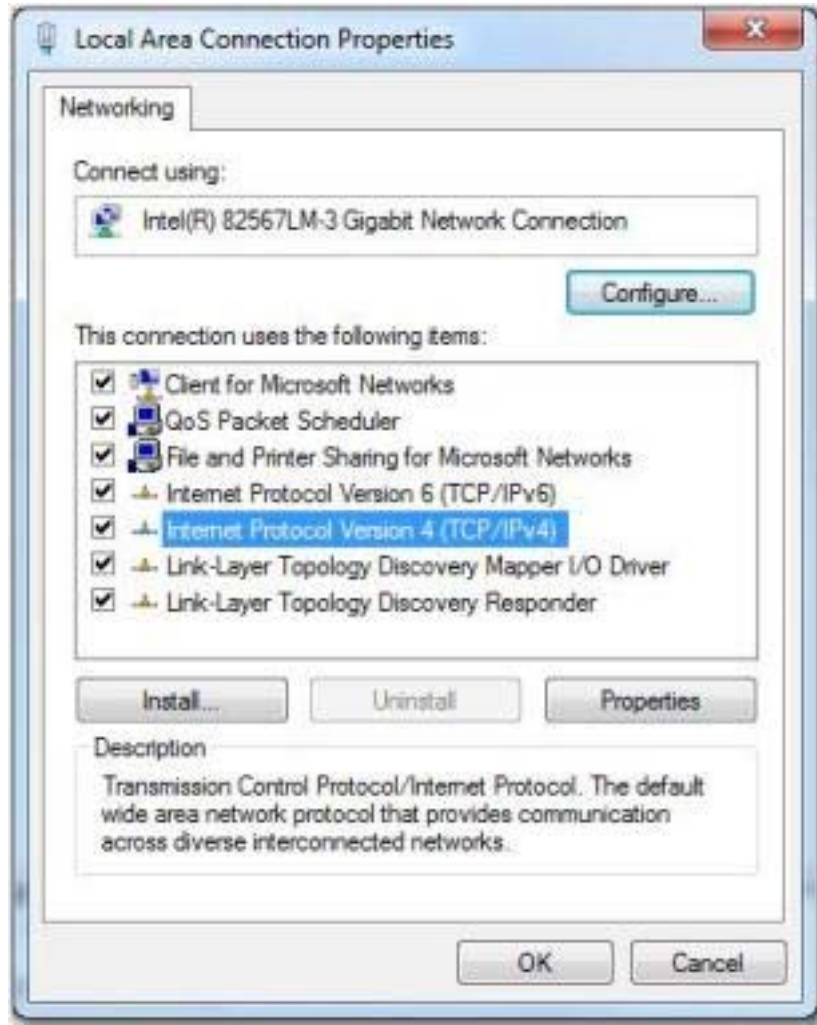

gtu170.jpg

- f. Select the **Alternate Configuration** tab.

*Note*

*The Alternate Configuration tab only shows if the PC is set up to automatically obtain an IP address (DHCP). If the PC has an IP assigned by the network administrator, use the address in the General tab. Record the current addresses so they will not be lost.*

- g. Select the radio button to the left of **User configured**. Fill in the fields as follows:
- IP address: **192.168.0.1**
  - Subnet mask: **255.255.255.0**
  - Default gateway: **192.168.0.250**

*Note*

*If the "Alternate Configuration" tab is not shown on the menu, it is OK to use these IP addresses in the General tab.*

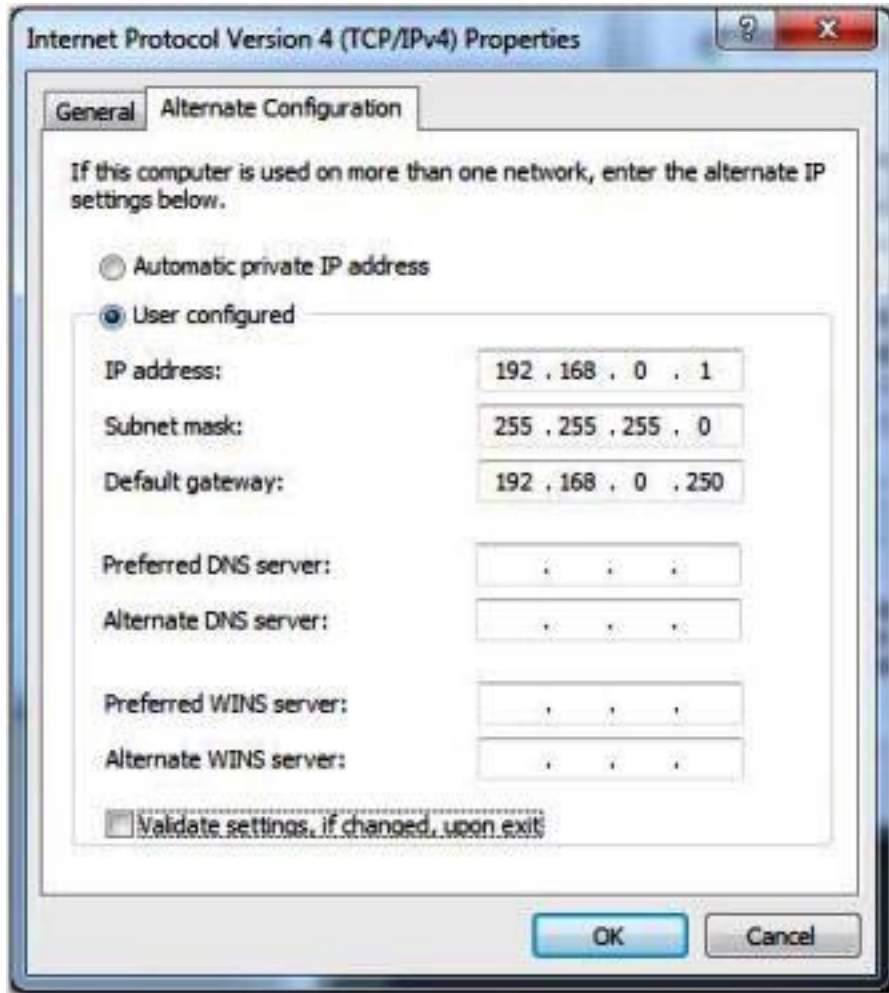

gtu171.jpg

- h. Uncheck **Validate settings, if changed, upon exit** and click **OK**.
- i. Wait 5 minutes for the Client PC to make a connection to the Server PC.

*Note*

*After the connection is made, Windows automatically opens the Set Network Locations dialog that lets you set a network location. Set the network location to "Work" or "Home Network". If this dialog does not automatically open, continue to the "Set Location of Network" section.*

4. Change the location of the network as follows:

*Note*

*Skip this step if the location of the network was previously set.*

- a. Open the **Windows Start Menu** and type “network and sharing” in the search box.

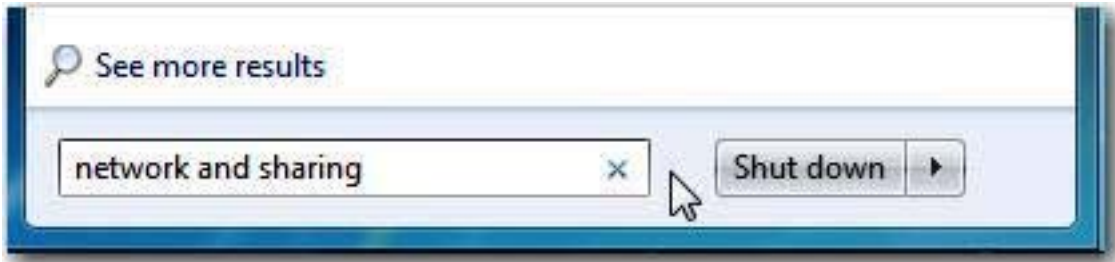

gtu172.jpg

- b. Click **Network and Sharing Center**.

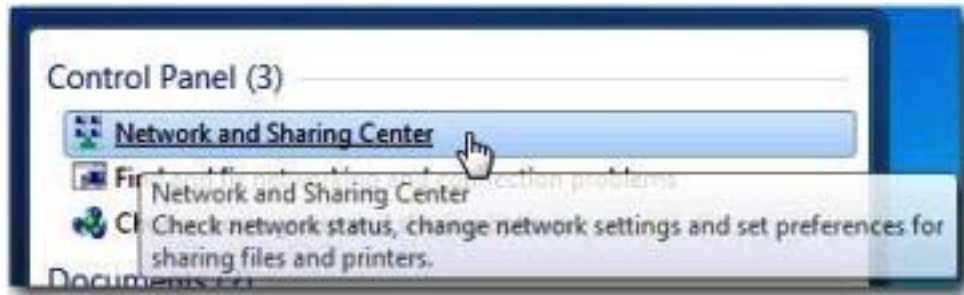

gtu173.jpg

- c. Click on the network listed in active network.

*Note*

*If the active network shows “Public Network” and it cannot be changed, check the adapter setting again. Use the instructions in the previous section.*

- d. On the Network and Sharing Center menu, make sure the network location is set to “**Home Network**” or “**Work Network**”.

*Note*

*If the network location is set to “Public Network”, the Calibration System should be able to connect to the Calibration System Server using the Auto Discovery.*



gtu174.jpg

- e. Open the Calibration Software and set up the file storage directory (refer to “Set Up the File Storage Directory”).

### Set Up the File Storage Directory

After the Calibration Software is installed, it is necessary to set up the file storage location. This is where the software settings, test files, results files, and report files are saved to (refer to Chapter 4 for more information on these files).

*Note*

*System data files are not stored in the same location as the Calibration System software.*

When the Calibration Software is opened for the first time, the software automatically opens the Folder Location Settings menu (see Figure 2-3 and Table 2-1) to set up the file storage location. After the folder location is set, the separately supplied test files must be installed using the option from the Folder Locations Settings menu.

*Note*

*The Calibration Software cannot be used until the file storage location is set.*



**Figure 2-3. First Time Setup**

gtu113.jpg

1. After clicking on OK in the message shown in Figure 2-3, the Folder Location Settings screen will be displayed. Refer to Table 2-1.

*Note*

*Fluke recommends that you use the default folder locations. If a different folder is necessary, click on the folder icon to the right of the Working Directory Path and choose a new folder. A Windows Explorer dialog box opens.*

2. Choose the directory (the working top level folder) and subfolder locations (see Table 2-1). To have the PMUCal Software automatically make the subfolders, check the “Create all subfolders under this Working Folder” check box. To manually set the subfolder locations, uncheck the “Create all subfolders under this Working Folder” check box.

*Note*

*The ability to manually set the subfolders is disabled when the “Create all subfolders under this Working Folder” is checked.*



Table 2-1. Folder Location Settings

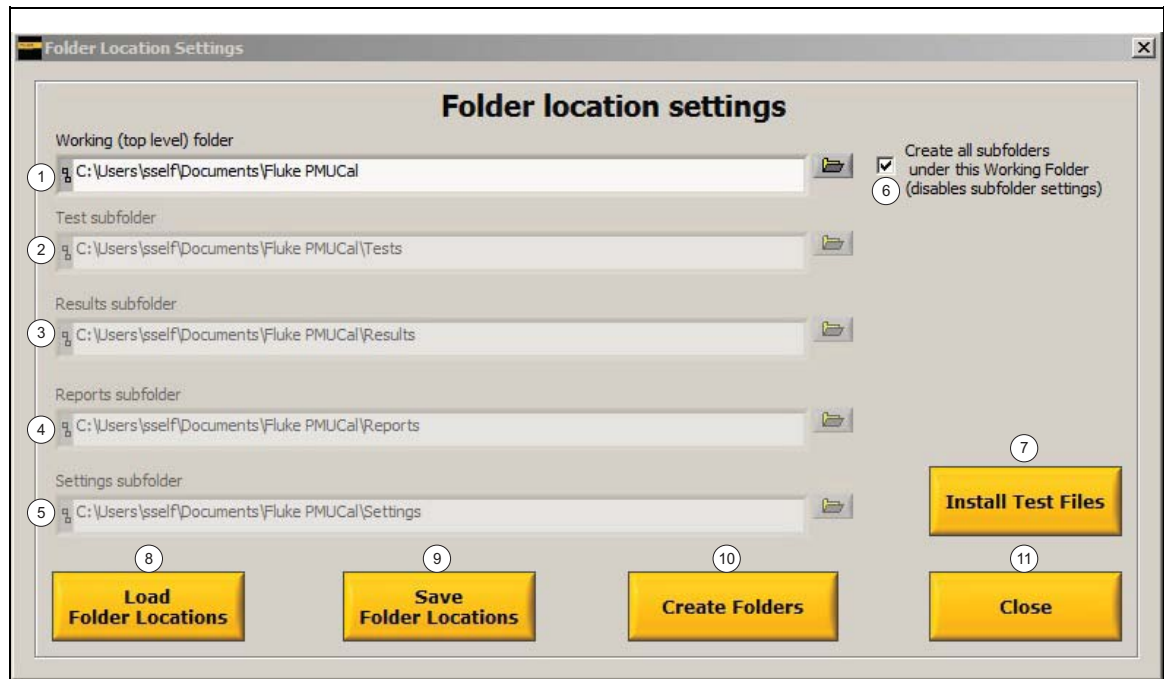

tu135.eps

Item	Name	Description
①	Working (top level) folder	Path of the top-level directory that contains the settings, tests, results, and reports subdirectories.
②	Test Subfolder	Path of the directory that contains the compliance tests made with the test maker tool (refer to “About the Test Files and Test Results Data Files” in Chapter 4).
③	Results Subfolder	Path of the directory that contains test results (refer to “About the Test Files and Test Results Data Files” in Chapter 4).
④	Reports Subfolder	Path of the directory that contains test reports.
⑤	Settings Subfolder	Path of the directory that contains all the calibration software settings.
⑥	Create all subfolders under this Working Folder (Selection box)	Automatically makes default settings, test, results, and reports subdirectories when selected.
⑦	Install Test Files	Installs test files.
⑧	Load Folder Locations	Loads the directory paths previously saved to a path configuration file.
⑨	Save Folder Locations	Saves the current directory paths shown to a path configuration file.
⑩	Create Folders	Applies current folder settings.
⑪	Close	Closes dialog box.



**Install the Test Files**

The test files used by the system are supplied separately. They can be found in a .zip file in the Test Files folder on the Calibration System software installation CD-ROM.

To install the test files:

1. Click on the **Install Test Files** button.
2. Follow the prompts to the location of the files. This will be in the Test Files folder of the Calibration System software installation CD-ROM.
3. Highlight the required zip file as shown in Figure 2-4.
4. Click on **Select File** to start the installation process.
5. A “File transfer complete” message will appear once the test files have been successfully installed.

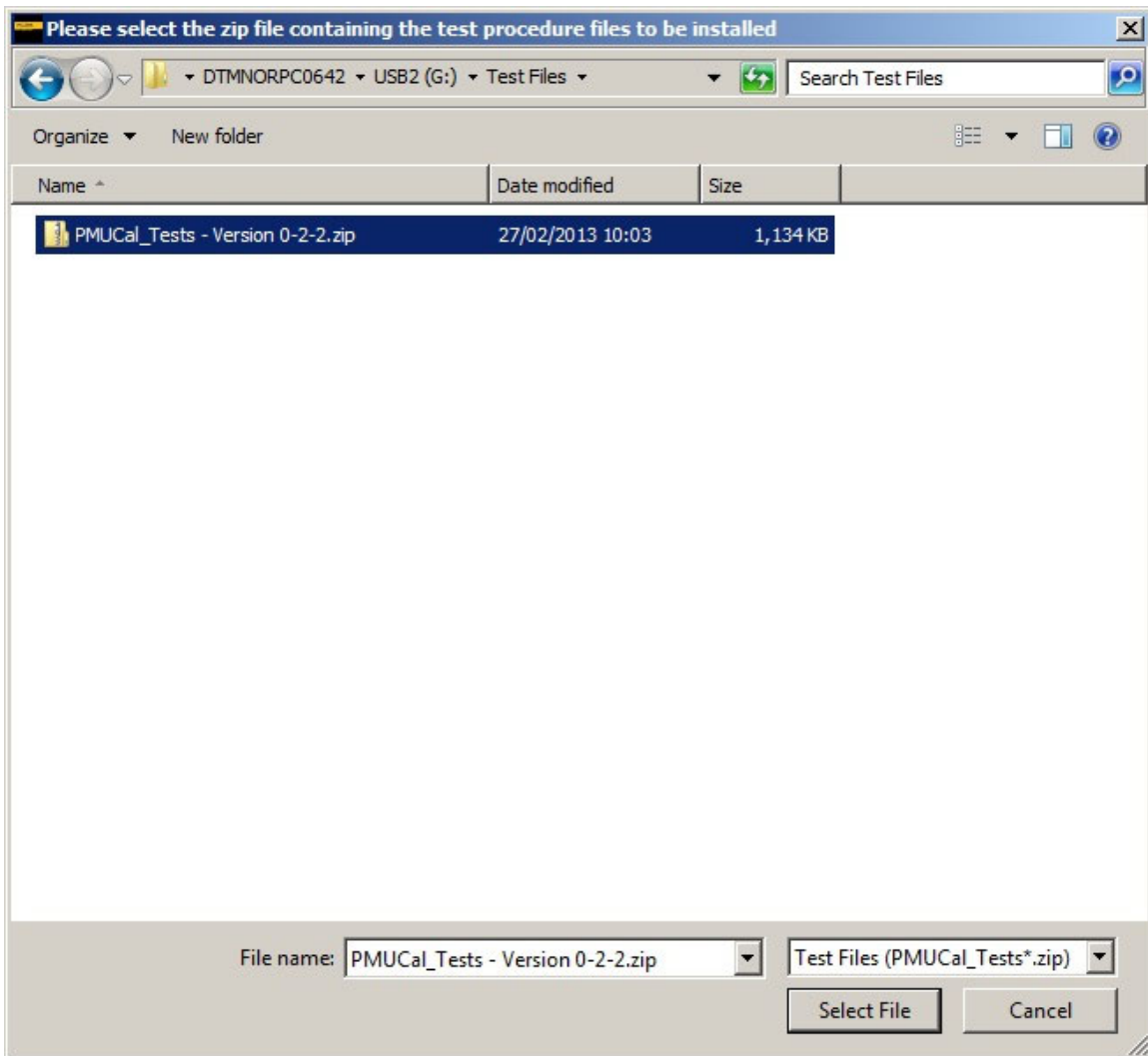

**Figure 2-4. Test File Selection**

gtu144.jpg

After both the folders have been created and tests installed, click “Close” to close the folder location settings dialog box. Use the instructions in Chapter 4 to use the Startup menu to connect to the Server PC and a UUT.

Folder location settings can be changed or new test files installed at a later date as follows:

1. Open the Calibration Software.
2. Click **Settings** in the Main Menu.
3. Click **File and Folder Settings**.

# Chapter 3

## Software Operation

Title	Page
About this Chapter .....	3-3
UUT Calibration Procedure .....	3-3
Overview .....	3-3
Calibration Procedure Information .....	3-4
Calibration Compliance to IEEE C37.118.1-2011 .....	3-4
About Synchrophasor Calibration .....	3-6
Time to Complete a UUT Calibration .....	3-7
Calibration Test Measurements .....	3-7
Calibration Procedure Preparation .....	3-7
UUT Configuration .....	3-8
UUT and Simulator Personality Profiles .....	3-8
UUT Personality Profile .....	3-8
Simulator Personality Profile .....	3-11
Testing Methods .....	3-12
Automated Testing .....	3-14
General and Custom Interactive Test Methods .....	3-14
General Interactive Testing .....	3-15
Custom Interactive Testing .....	3-15
Interactive Test Sequence of Events .....	3-16
Run the Test .....	3-16
Set Up the Interactive Graph .....	3-17
Analyze the Data on the Interactive Graph .....	3-17
Modes of Operation .....	3-18
Simulation Mode .....	3-19
PMU Test Mode .....	3-19
Standard Compliance Tests and Test Files .....	3-19
Standard Compliance Tests and Subtests .....	3-21
Steady State Compliance Tests .....	3-21
Dynamic Compliance Tests .....	3-22
Standard Compliance Tests File Naming Convention .....	3-23
Automated Test List Files .....	3-25
Test Results and Results Files .....	3-25
About Result Files and the Active Results File .....	3-25
Results Files Naming Convention .....	3-26
Result File Save Options .....	3-27
Results File Storage Directory .....	3-28
Raw Data Files .....	3-28
Test Report and Calibration Report .....	3-28



## About this Chapter

This chapter supplies information on the PMUCal Software supplied with the Calibration System. The beginning of the chapter provides information on the UUT calibration procedure that is controlled by the PMUCal Software. This information is followed by functionality and feature information to help understand the different testing methods and modes of operation available. For an alphabetical list of terms and abbreviations used in this chapter and manual, see “The Glossary” in Appendix A of this manual.

## UUT Calibration Procedure

### Overview

UUT calibration is a performance verification procedure to make sure that a UUT is in accordance with the performance requirements specified in *IEEE C37.118.1-2011, Synchrophasor Measurements for Power Systems Specification*. The Product compares phasors from the UUT with the reference voltage and current phasors it generates.

#### Note

*The word “reference” or “actual” in this manual refers to the calibrated source output signals from the 6135A System to the UUT. The word “measured” refers to the measured signals from the UUT outputs.*

The basic UUT calibration procedure is illustrated in Figure 3-1. This illustration shows the procedure to calibrate or test a UUT. Each topic references to helpful information and procedural instructions in this manual.

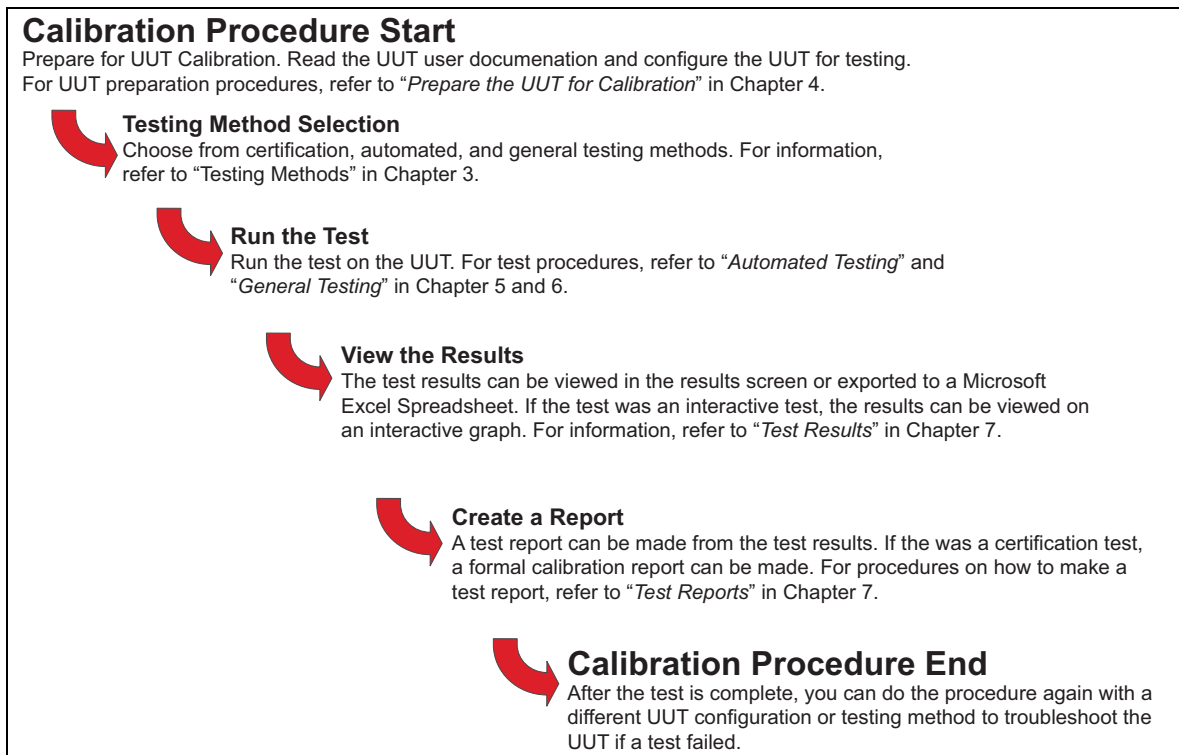

Figure 3-1. Calibration Procedure with References

gtu083.eps

### Calibration Procedure Information

The UUT calibration procedure illustrated in Figure 3-2 is a remotely operated procedure that is controlled by the PMUCal Software. To certify a UUT, the PMUCal Software is configured to run preprogrammed automated certification tests (the certification tests). A certification test is an automated test file that contains a noneditable list of sequenced tests (refer to “Automated Testing” in this chapter). A certification test contains more than 1,000 individual sequenced tests derived from the standards. Each certification test is configured for a nominal UUT frequency, a UUT reporting rate, and a UUT class.

When a test is run, the PMUCal Software sends data to the Server PC to configure the test. The Server PC uses the data to configure and initialize the Calibration System. At the set test start time, the Server PC starts the test and actively controls all of the Calibration System outputs.

While the test is in progress, the Server PC records the reference data from the 6135A System and the measured data from the UUT. The reference and measured data is sent to the Client PC and the maximum test values are saved to the active test results file (see “Standard Compliance Tests and Test Files” in this chapter).

When the test is complete, the Calibration Software updates the active test results file which can viewed on the Results screen or can be exported to Microsoft Excel file. If the test done was a certification test and all tests passed, a formal certification report can be generated.

For more information on Automated Testing and Interactive Testing, refer to “Testing Methods” in this chapter.

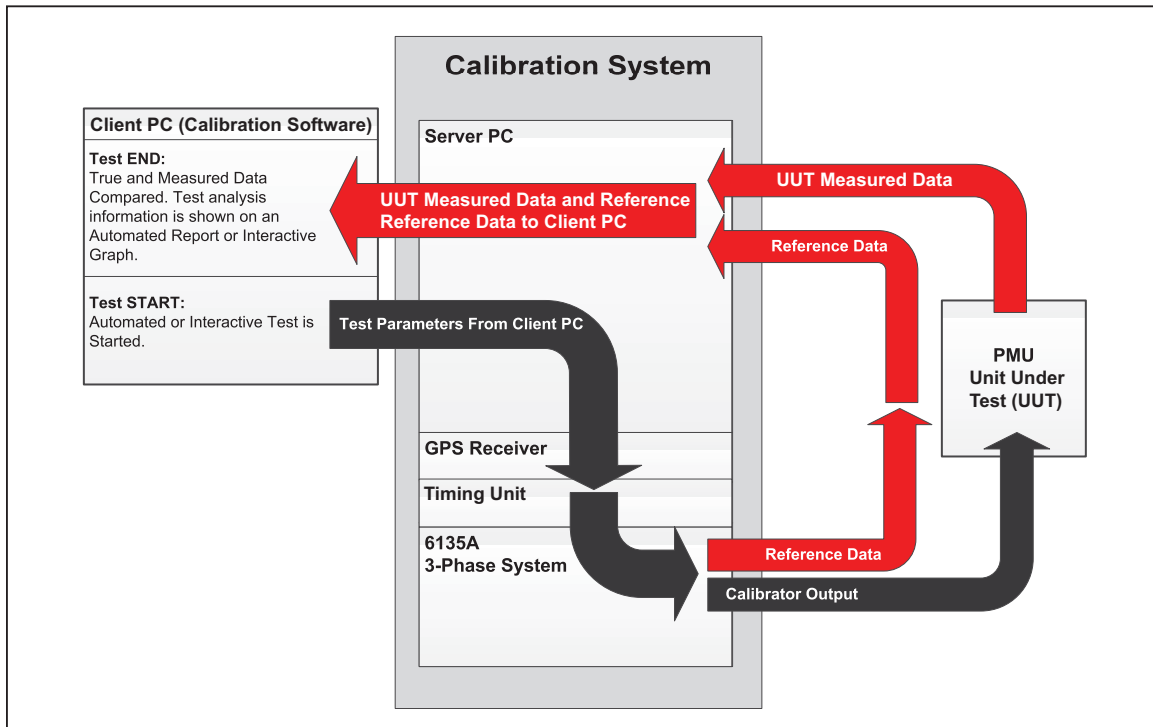

Figure 3-2. How the Calibration System Calibrates a UUT

gtu057.eps

### Calibration Compliance to IEEE C37.118.1-2011

The Fluke 6135A PMU Calibration System was developed to provide PMU manufacturers and third party calibration organizations with a system to demonstrate compliance to *IEEE C37.118.1-2011* (the Standard). The Calibration System is more than 10 times more accurate than the PMU test limits in the Standard.

The Standard defines three types of test: Static performance, Dynamic performance, and reporting Latency. The tests are all represented mathematically in the Standard. With one dynamic test type exception and Latency tests, the PMU must meet test criteria for Total Vector Error (TVE), Frequency Error (FE) and Rate of Change of Frequency Error (RFE). The Figure 3-3 shows the errors of synchrophasor magnitude, phase angle, or time that would individually contribute to 1 % TVE.

The three factors that affect TVE are: timing error, magnitude error, and phase angle error. Table 3-1 and Figure 3-3 shows the accuracy required for each individual contribution assuming the other two are zero.

The 6135A System Users Manual describes how all the output signals are calibrated for magnitude and for alignment with the digital phase reference signal from the 6135A System rear panel. The 6135A System specifications show that if the phase reference signal can be perfectly aligned with the UTC 1 PPS, the magnitude phase angle and timing error will be at least 100 times better than the PMU test limits. Figure 3-5 shows a simplified block diagram of the Fluke 6135A PMU Calibration System.

**Table 3-1. Accuracy Requirements**

	<b>TVE</b>	<b>Magnitude</b>	<b>Angle</b>	<b>Time (μs) (50/60 Hz)</b>
PMU	1 %	1 %	0.573°	31.7 / 26.5
Fluke PMU Calibrator	<0.1 %	<0.1 % <sup>[1]</sup>	<0.0573°	1.1
6135A at nominal frequency	N/A	0.006 % <sup>[2]</sup>	0.0056°	0.3

Notes:  
 [1] - As seen by PMU with 10 % Interharmonic added.  
 [2] - Pure sine wave.

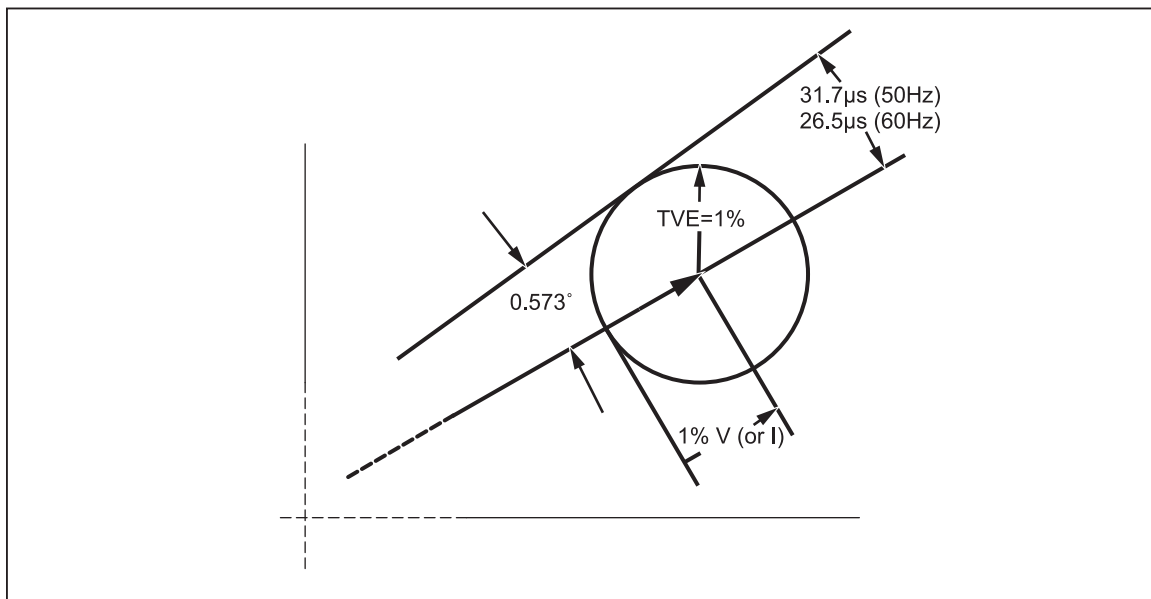

**Figure 3-3. Accuracy Requirements (Illustration)**

gtu176.eps

### About Synchrophasor Calibration

For a PMU to generate synchrophasors, a PMU must either have its own built in time reference or take Coordinated Universal Time (UTC) from an external device. UTC is most commonly obtained from a GPS device and the PMU may receive satellite data from an aerial. If the PMU does not have an integral GPS receiver, it is provided using well defined synchronization data such as IRIG-B.

A PMU can be configured for nominal 50 Hz or 60 Hz grids and as Measurement or Protection devices (M or P). Protection devices control switch gear to automatically isolate faults. PMU configured as Measurement devices report to a central Phasor Data Concentrator for off-line monitoring and post event analysis. PMU are configured to report at specified reporting rates or Frame Rate (FS). In reality, the grid rarely operates at exactly nominal frequency and contains unwanted distortion components. The PMU must report Synchrophasors (a time-stamped Phasor) for the voltage and current fundamental frequency component at the selected reporting rate despite the non-perfect nature of the input. This means that input filtering is necessary. For the P class, the filter is fixed irrespective of FS and that some aliasing of distortion will inevitably result is reflected in the P Class PMU test limits. The rate that an M class PMU reports determines the anti-aliasing filtering that can be applied and thus the PMU bandwidth.

The mathematical formula for a synchrophasor is:

$$x(t) = X_m \text{Cos}(\omega t + \phi)$$

The cosine function at the nominal system frequency is synchronized to UTC when  $t=0$  and  $\phi=0$ . The Synchrophasor angle is 0 degrees when the maximum of  $x(t)$  occurs at the UTC second rollover. The second rollover is known as the 1 PPS (pulse per second) time signal. See Figure 3-4.

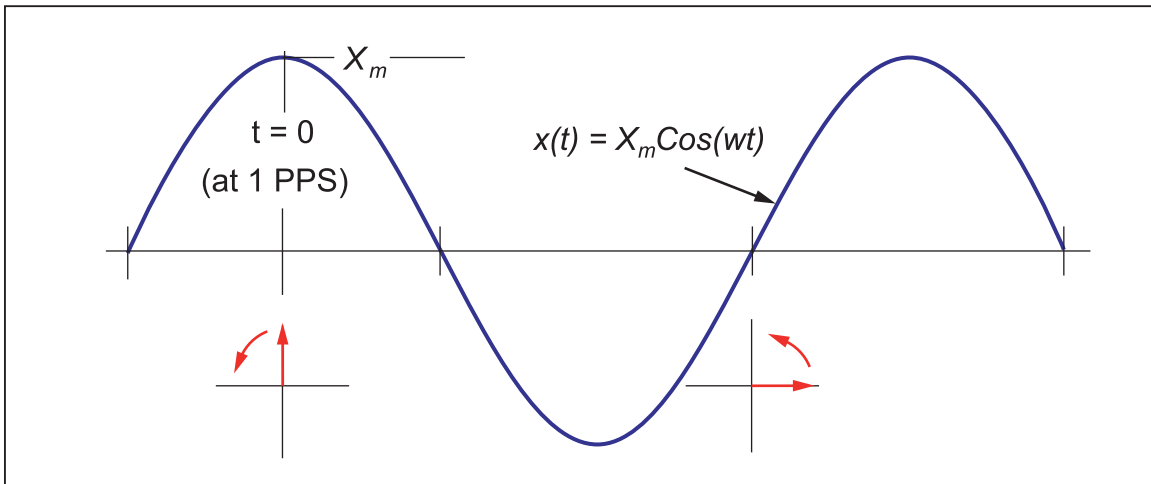
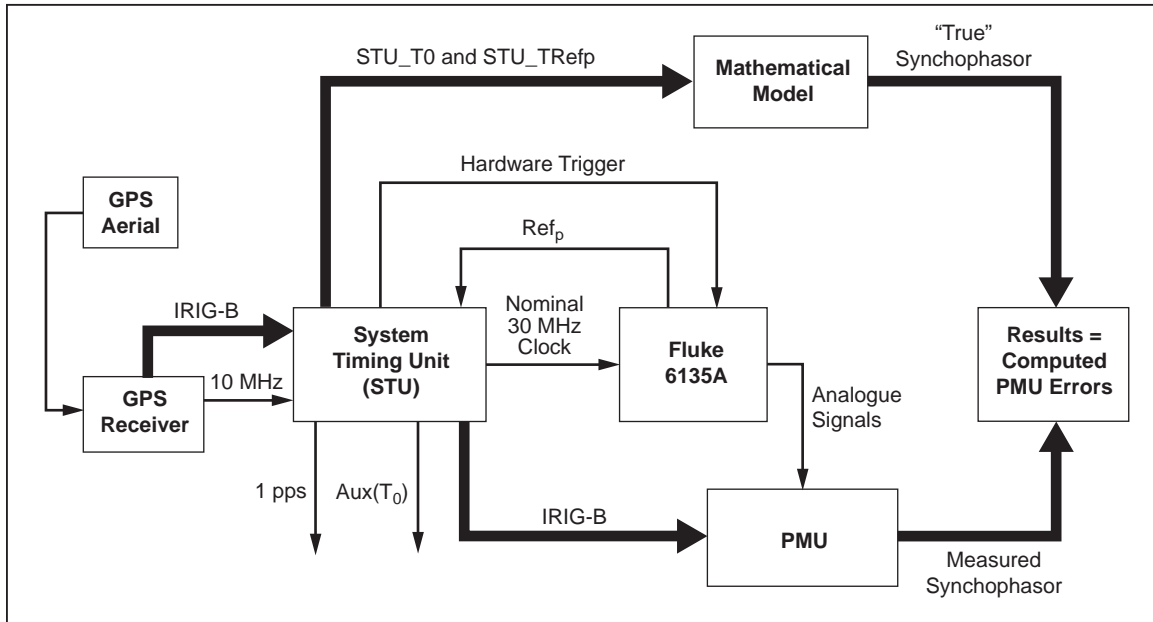

Figure 3-4. Synchrophasor Angles

gtu175.eps





**Figure 3-5. Simplified Block Diagram of the 6135A/PMUCAL**

gtu177.eps

### **Time to Complete a UUT Calibration**

To fully calibrate a UUT, each UUT configuration must be tested. A UUT configuration consists of one nominal frequency setting, one reporting rate setting, and one class setting. If one of these settings changes, it is considered a configuration change. On average, 6 hours to 10 hours of continuous automated testing is necessary to verify the performance of one configuration. M Class UUTs and UUTs with higher reporting rates take longer to test because they have more tests to run.

Some UUTs have a configurable range of nominal frequencies, reporting rates, and classes that can be changed in the UUT configuration. These additional configurations must be tested and verified to certify the UUT.

### **Calibration Test Measurements**

The measurements in this section are unique to UUT calibration. A simplified definition of each measurement is in the Glossary of this Operators Manual and expanded definitions are in *IEEE C37.118.1-2011, Synchrophasor Measurements for Power Systems Specification*. The test report and interactive graph uses these measurements to show errors between the reference and measured data.

The common measurements are:

- Total Vector Error (TVE)
- Frequency Error (FE)
- Rate of Change of Frequency Error (RFE)
- Step test results:
  - Response Time
  - Delay Time
  - Overshoot

Refer to the Glossary for definitions of each common measurement.

### **Calibration Procedure Preparation**

Before the calibration procedure is started, it is necessary to configure the UUT and also set up the UUT personality in the PMUCal Software. The information in this section describes the differences between the UUT configuration and the UUT personality

profile. For instructions on how to make or edit a UUT personality, see “Set Up a Personality Profile” in Chapter 4.

### **UUT Configuration**

The UUT configuration is the internal configuration settings of the UUT.

#### *Note*

*It is not possible to change the UUT configuration items with the PMUCal Software. To change the UUT configuration, refer to the UUT user documentation.*

The UUT configuration includes:

- The nominal frequency of the UUT (F0).
- The reporting rate of the UUT (Fs).
- Class of the UUT. If necessary, contact the UUT vendor for instructions on how to configure the UUT for P or M class performance.
- Current turns (CT) and potential turns (PT) ratio. Must be set to a 1:1 ratio.

When a connection is made to a UUT, the PMUCal Software requests the UUT configuration information from the UUT and loads it into the configuration. If any of the configuration information needs changed, disconnect the UUT, reconfigure it, and then try again.

#### *Note*

*If changes are made to the UUT configuration after you set up the UUT personality profile (refer to “UUT and Simulator Personality Profiles”), you must reconnect using the PMU Personality dialog in the Settings menu to get the updated UUT configuration information.*

Refer to the UUT user documentation for instructions on how to change the UUT configuration.

### **UUT and Simulator Personality Profiles**

#### **UUT Personality Profile**

The UUT personality profile is a file that stores unique information about the UUT that can be changed with the PMUCal Software. The UUT configuration items are shown on the UUT personality profile screen for reference. Figure 3-6 and 3-7 shows the UUT personality profile screens.

#### **⚠ Caution**

**To prevent inaccurate test results, it is important to use accurate UUT information when you make a UUT personality profile. To make the test results, the Calibration Software compares the test results to the IEEE C37.118.1-2011 performance limits for nominal frequency, reporting rate, and class in the UUT personality profile. If incorrect information is in the UUT personality profile, the results will be compared to the incorrect IEEE C37.118.1-2011 performance limits. The IEEE C37.118.1-2011 performance limits are significantly different for each class.**

The screenshot shows a software window titled "PMU Personality" with two tabs: "PMU Information" (selected) and "Phase Order". The main content area is titled "PMU Personality" and contains the following fields and sections:

- Manufacturer:** Default PMU Manufacturer
- Model:** Default PMU Model
- Identifier:** Default PMU
- Serial Number:** (empty field)
- PMU Connection Details:**
  - ConnectionType: TCP
  - IP: 192.92.92.92
  - Port: 4712
  - ID: 1
  - Version: 2
- PMU Settings:**
  - PMU Class:  M-Class,  P-Class
  - Nominal Voltage: 70.0
  - Nominal Current: 5.0

At the bottom of the window are five yellow buttons: "Load", "Save", "Connect to PMU and get PMU Config", "Done", and "Cancel".

gtu032.jpg

Figure 3-6. UUT Personality Screen (Information Tab)

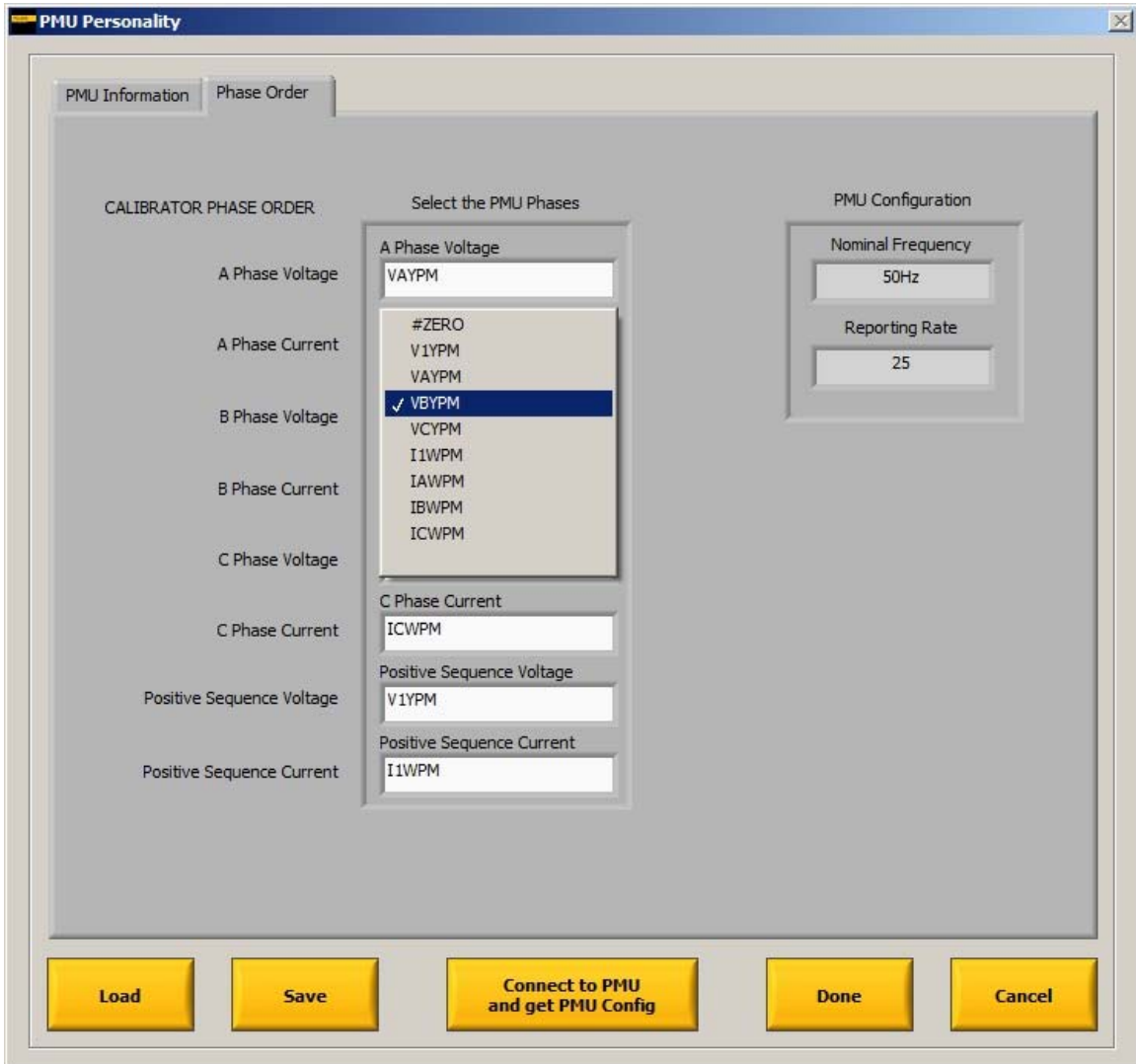
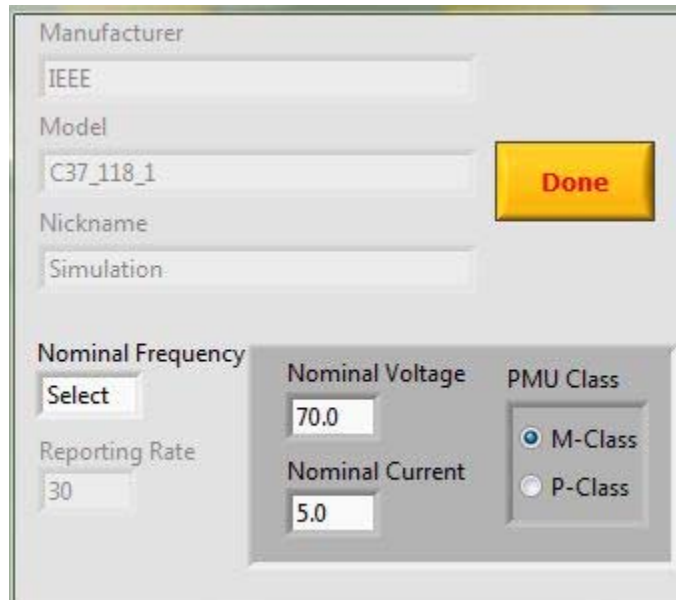

Figure 3-7. UUT Personality Screen (Phase Order)

gtu033.jpg

**Simulator Personality Profile**

The Calibration Software has a default simulator personality profile (the simulator profile) to change the personality of the built-in UUT simulator. The simulator profile loads each time you choose Simulation Mode on the main startup window. Unlike the UUT profile, the simulator profile lets the operator change the UUT configuration items such as nominal frequency, reporting rate, class, nominal voltage, and nominal current.



**Figure 3-8. UUT Personality Profile**

gtu069.jpg

## Testing Methods

A UUT can be tested with one of three methods: automated testing, general interactive testing, or custom interactive testing. To certify and verify a UUT's performance, the automated testing method must be used. Selection of a testing method depends on the test requirements and what format test results must be in. The testing methods and test features are compared in Table 3-2.

**Table 3-2. Testing Method Comparison**

Testing Method	Features
Certification Testing	<p>Certification testing can:</p> <ul style="list-style-type: none"> <li>• Test the UUT against all the performance standards in IEEE C37.118.1-2011 for each class, nominal frequency, and reporting rate.</li> <li>• Make a formal certification report.</li> </ul> <p style="text-align: center;"><i>Note</i></p> <p><i>The certification test sequence is defined by the requirements in IEEE C37.118.1-2011, Synchrophasor Measurements for Power Systems Specification and cannot be changed.</i></p>
Automated Testing	<p>Automated testing can:</p> <ul style="list-style-type: none"> <li>• Run a large number of tests without interaction.</li> <li>• Test the UUT against the performance standards in IEEE C37.118.1-2011.</li> <li>• Open and customize the test results in a formatted Microsoft Excel Spreadsheet.</li> <li>• Make a new or change an automated test list.</li> <li>• View the results compared to the test limits on the results screen.</li> <li>• Plot the data from a test run from the results log screen.</li> </ul>
General Interactive Testing	<p>General interactive testing can:</p> <ul style="list-style-type: none"> <li>• Run a single pre-configured test on the UUT.</li> <li>• See the test results in an interactive graph that can be customized.</li> <li>• View the results compared to the limits on the results screen.</li> </ul>
Custom Interactive Testing	<p>Custom interactive testing can:</p> <ul style="list-style-type: none"> <li>• Run a single pre-configured test on the UUT.</li> <li>• Make a new test or load and change a test.</li> <li>• Run tests and change test parameters before they are saved to fine-tune test configurations.</li> <li>• Help you troubleshoot a UUT.</li> <li>• View the results compared to the test limits on the results screen.</li> </ul>

Figure 3-9 illustrates the automated test and interactive test process. For instructions on how to do an automated test or a general test, see Chapter 5 and Chapter 6.

See the subsequent sections for more information on each testing method.

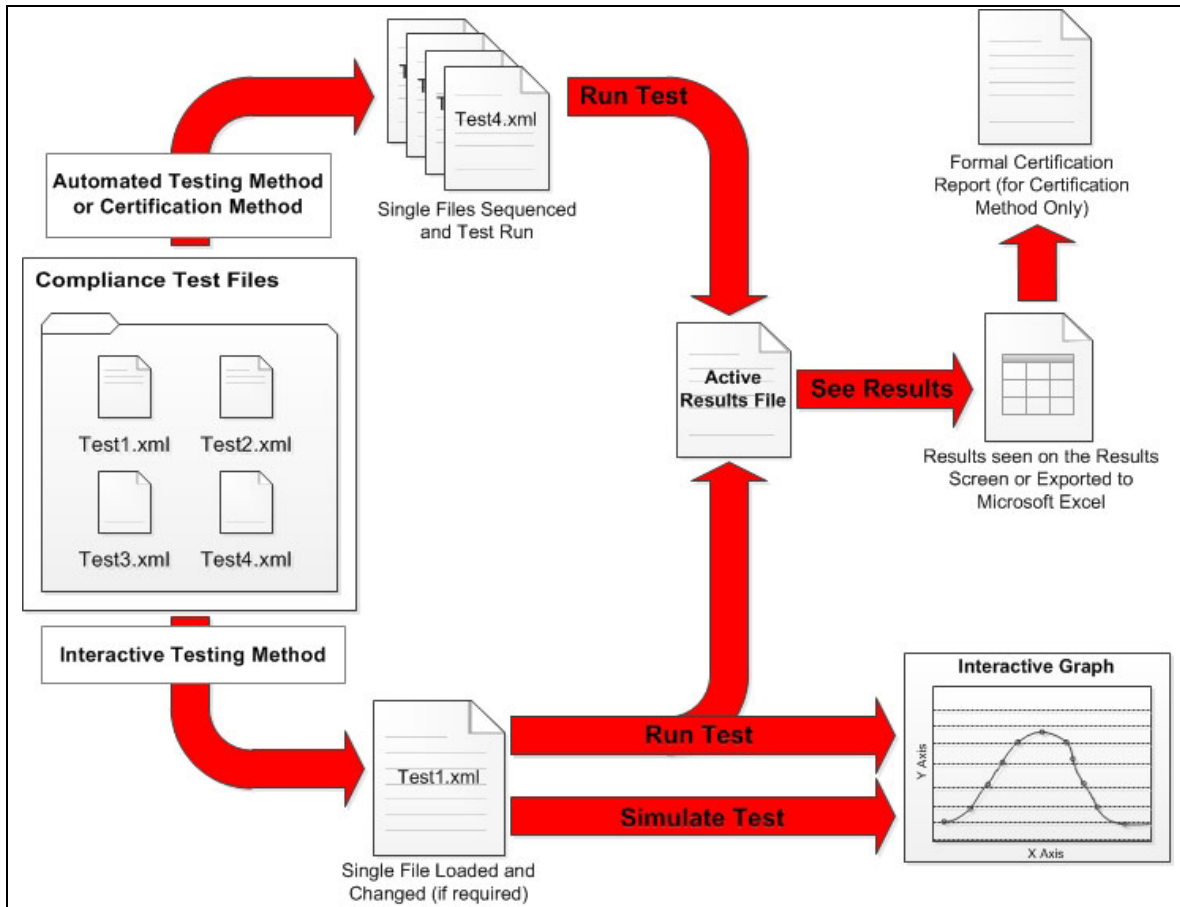

gtu042.jpg

Figure 3-9. Interactive and Automated Results

### Automated Testing

An automated test runs a list of tests one-by-one without the need for operator interaction. As the tests are completed, the Calibration Software saves or overwrites the maximum test results values to the active results file (refer to “Standard Compliance Tests and Test Files” in this Chapter). Figure 3-10 shows the automated tests setup dialog that contains the list of test files and the buttons to manage the files in the list.

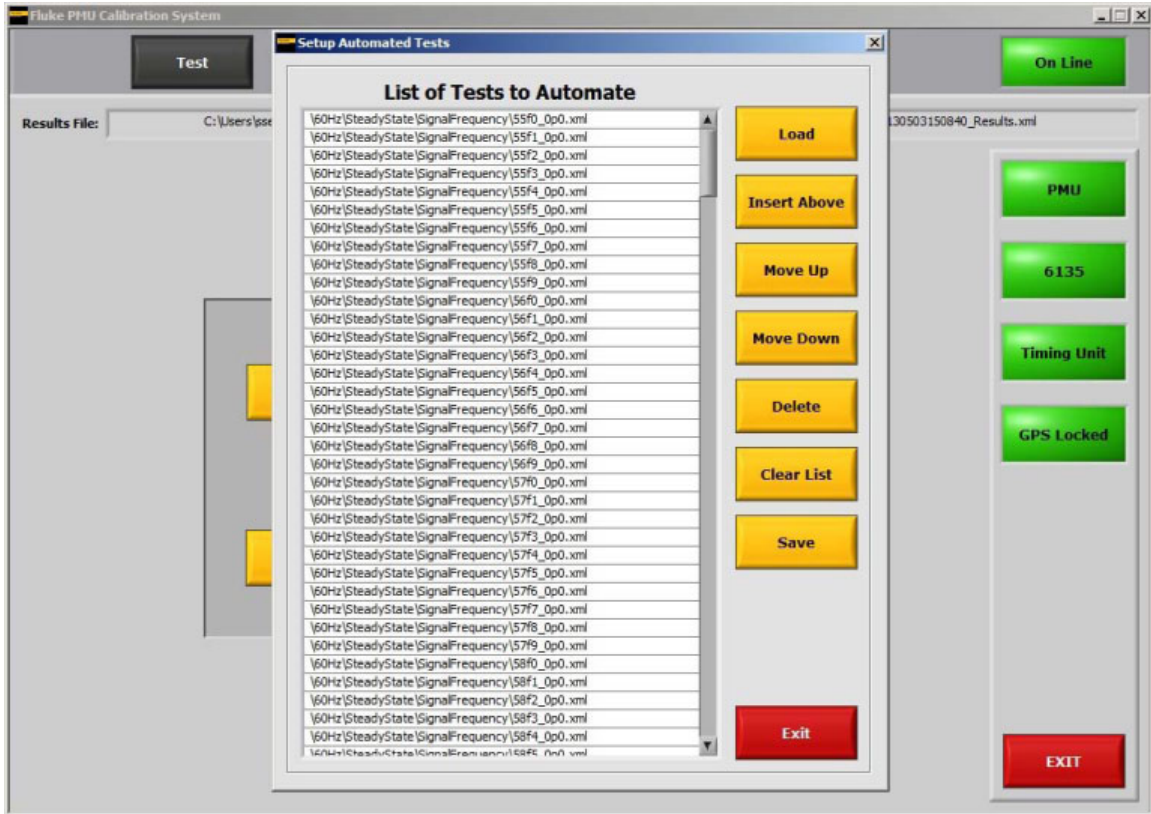

Figure 3-10. Automated Testing Menu and Screen

gtu071.jpg

The Calibration Software comes with a full set of automated test list files that are configured to run all the compliance tests listed in *IEEE C37.118.1-2011, Synchrophasor Measurements for Power Systems Specification* (see “Standard Compliance Tests and Test Files” in this chapter). The automated test list files that come with the Calibration Software can be changed to suit the calibration requirements. The operator can create new automated test list files for special purposes such as production testing or UUT design regression testing.

For instructions on how to do an automated test, see Chapter 5.

### General and Custom Interactive Test Methods

The Calibration Software supplies two methods to do an interactive test: general interactive testing and custom interactive testing. Read the subsequent sections for a comparison of the two methods.



### General Interactive Testing

General interactive testing (see Figure 3-11) is a basic test method that loads a single, preconfigured test file and interactively graphs the test results. When **Run Single Test** is clicked, the PMUCal Software loads a test from a file that you select and runs the test with the test parameters saved in the file. Use general interactive testing to show the currently loaded test parameters, load a different test file, and then closely evaluate the test data with the interactive graphing tools.

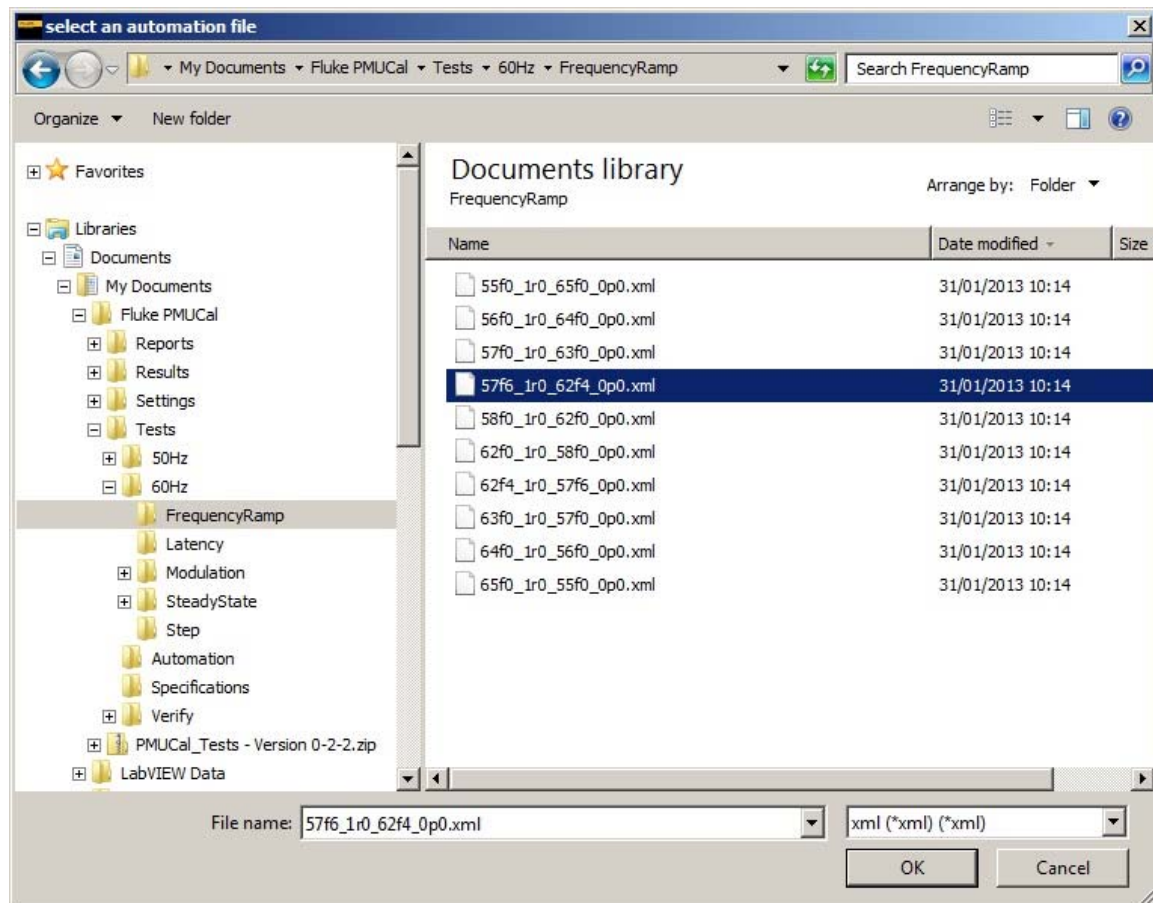

Figure 3-11. Run Single Test Window

gtu082.jpg

### Custom Interactive Testing

Custom interactive testing (see Figure 3-12) is an advanced test method to view and change test parameters and run tests instantaneously. When **Customize and Run Single Test** is clicked, the PMUCal Software opens the test configuration window.

#### Note

*Custom interactive testing is to help Engineers and Metrologists troubleshoot and calibrate a UUT. The test configuration window used for custom interactive testing is very complex and has advanced test options that can cause inaccurate results if not configured correctly.*

For instructions on how to do a general interactive or custom interactive test, see Chapter 6.

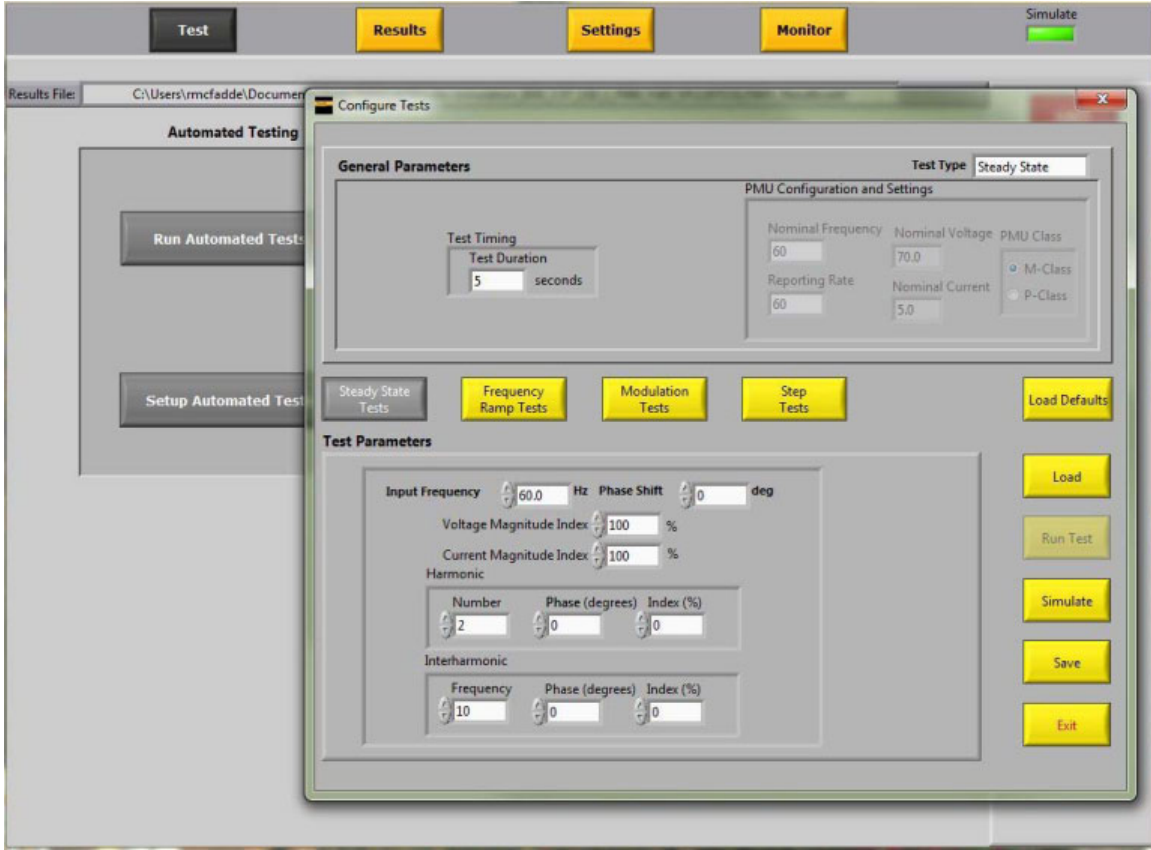

Figure 3-12. Test Configuration Window

gtu072.jpg

### Interactive Test Sequence of Events

#### Run the Test

When **Customize and Run Single Test** is clicked, the PMUCal Software opens the test configuration window. From here, the test parameters can be changed and the test can be run or simulated. When **Run Test** or **Simulate** is clicked on the test configuration window (see Figure 3-12), the PMUCal Software completes the test and saves the test results to the active results file in the results folder. While the test is in progress, a test status screen is shown (see Figure 3-13) that shows the test information as it is collected.

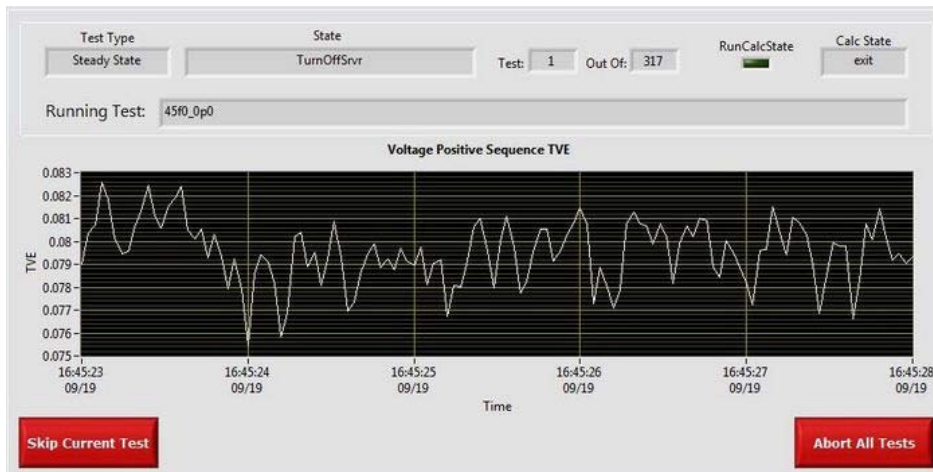

Figure 3-13. Test Progress Screen

gtu073.jpg

**Set Up the Interactive Graph**

After the test is complete, the graph configuration window (see Figure 3-14) opens that lets the operator configure the test results in the interactive graph (see “Interactive Graphs, Results, and Reports” in Chapter 8). When Plot Results is clicked, the PMUCal Software reads the test results data and makes the interactive graph.

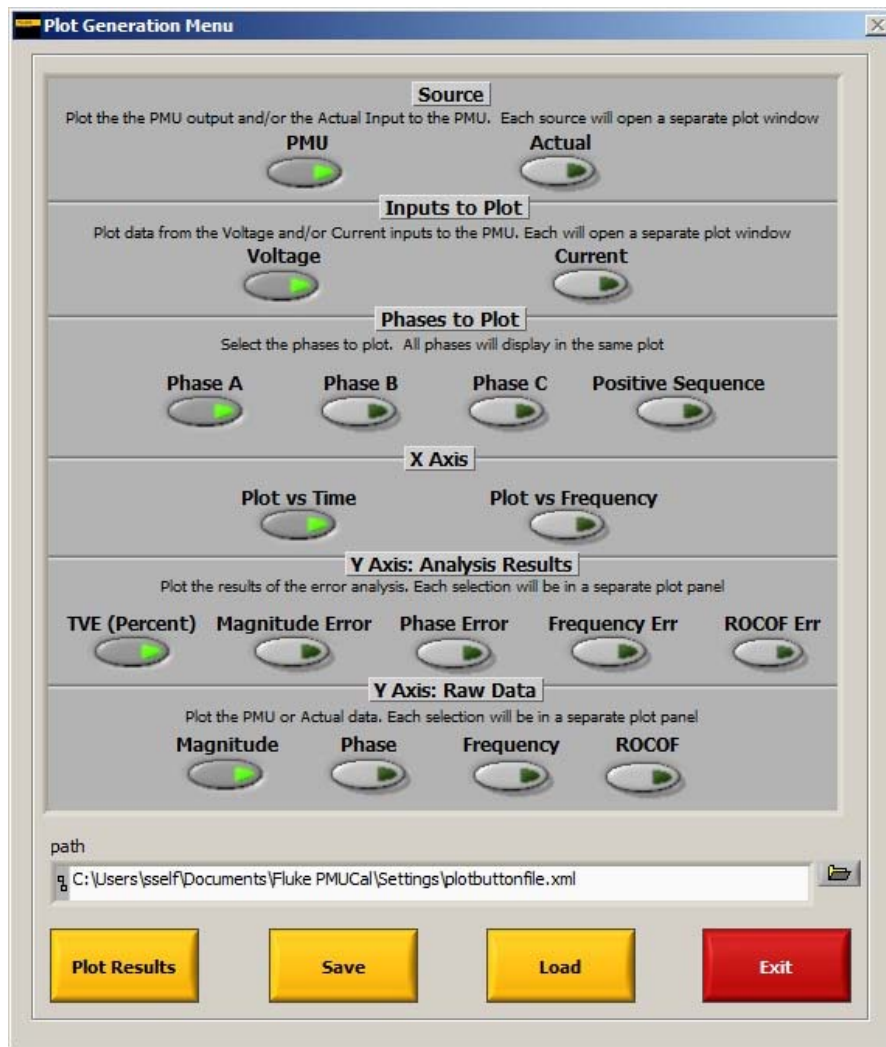

Figure 3-14. Graph Configuration Window

gtu074.jpg

**Analyze the Data on the Interactive Graph**

The interactive graph is an advanced test results viewer that used to closely analyze test results and raw output from the UUT and the Calibration System. The interactive graph has many view customizations to change the view of the data to clearly see the measurement values (set the graph dimensions, zoom-in and zoom-out both vertically and horizontally, change the plot types, and adjust the colors of the plot). For instructions on how to use these functions, see Chapter 7.

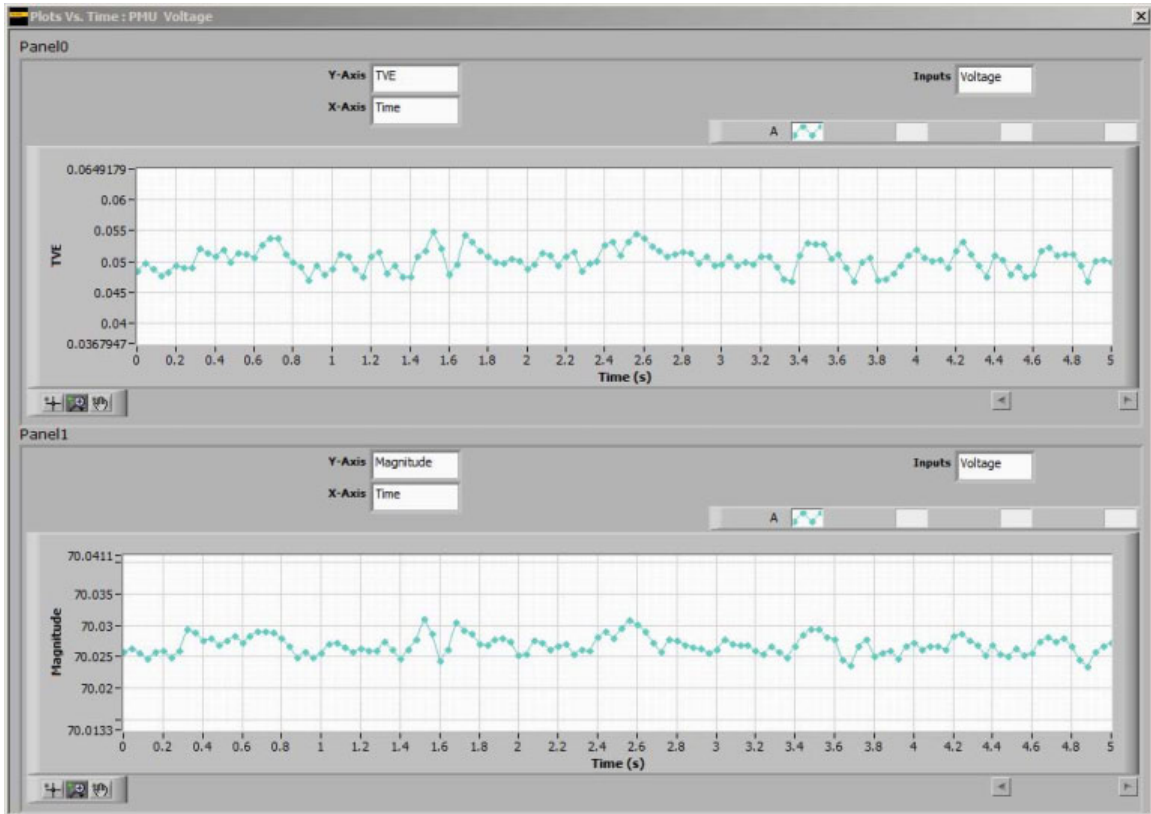

Figure 3-15. The Interactive Graph Screen

gtu075.jpg

## Modes of Operation

The Calibration Software has two modes of operation: Simulation Mode and PMU Test Mode. When the Calibration Software starts, a startup menu automatically opens to select the mode of operation. The mode of operation indicator (see Figure 3-16) on the top navigation menu shows you which mode of operation the Calibration System is in.

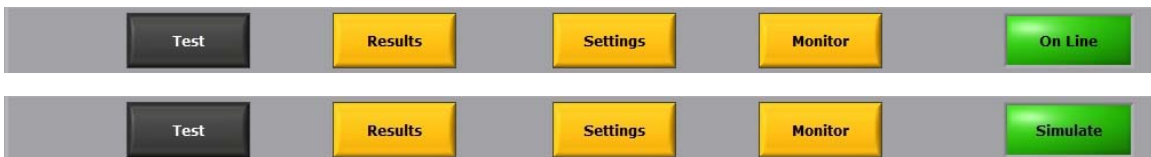

Figure 3-16. Mode of Operation Indicator

gtu062.jpg

See the subsequent sections for more information on each mode of operation.

### **Simulation Mode**

The Calibration Software comes with a fully programmed virtual PMU referred to as the PMU simulator. The PMU simulator has a default named personality profile (see “Simulator Personality Profile” in this Chapter). The PMU simulator is programmed to comply with *IEEE C37.118.1-2011, Annex C, Reference Signal Processing Models*.

You can use Simulation Mode to:

- Compare the performance of a UUT to the *IEEE C37.118.1-2011, Synchrophasor Measurements for Power Systems Specification, Annex C* model.
- Understand the Calibration Software functionality.
- Train users how to use the Calibration Software when a Calibration System is not available.

Features of Simulation Mode:

- Run an interactive and automated tests, plot and graph tests, and make reports.
- Save the test data from a simulated test to compare to a test done on a UUT.
- Set the phase inputs, nominal values, and reporting rate on a user-configurable personality.
- Use Simulation Mode with or without a connection to the Calibration System.

### **PMU Test Mode**

PMU Test Mode is the real test mode to connect to a UUT (see “Connect the Calibration System to a UUT” in Chapter 4).

*Note*

*If at any time the Calibration Software cannot make a connection to the Calibration System, the software prompts the operator to use in Simulation Mode (see Chapter 8).*

## **Standard Compliance Tests and Test Files**

The Calibration Software comes with all the test files necessary to certify and verify a UUT to *C37.118.1 - 2011*. These tests files are referred to as the standard compliance tests (the compliance tests). The folder that contains the test files is referred to as the test folder. The compliance tests are saved with fundamental test parameters in the filename to help visually identify the primary test parameters for each compliance subtest (see “Standard Compliance Test File Naming Convention” in this section). See the subsequent sections for information about how the compliance tests are made, the compliance test storage directory, and the compliance tests file naming convention. For information on how to install the test files, see Chapter 2.

Test files are organized by nominal frequency, compliance test, and compliance subtests (see Figure 3-17).

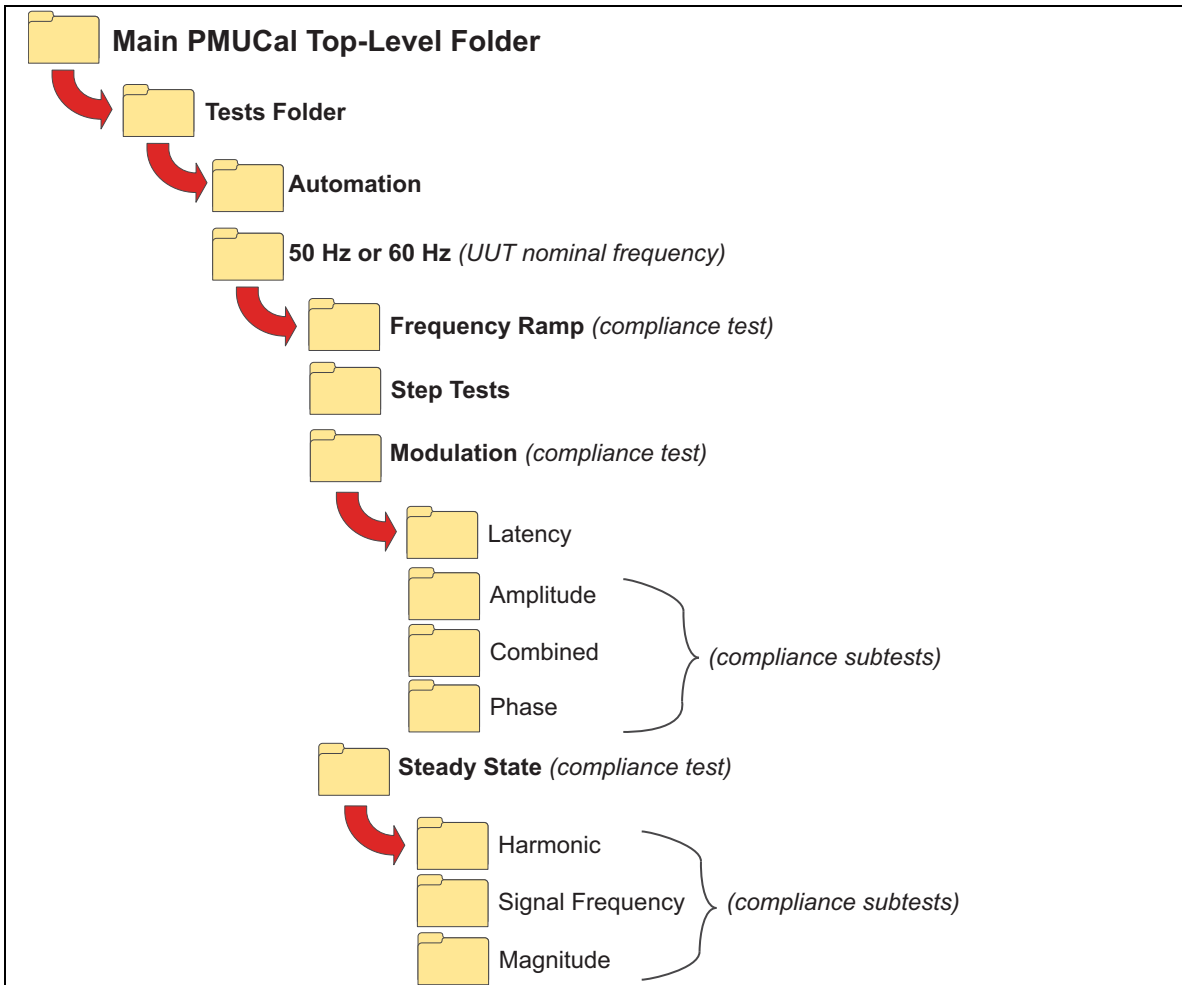

Figure 3-17. Default Test File Structure

gtu050.eps



## Standard Compliance Tests and Subtests

*IEEE C37.118.1, Synchrophasor Measurements for Power Systems Specification* is the standard that mandates which tests are required to certify and verify UUT performance. The three compliance tests types are steady state, dynamic, and message. The subsequent sections describe each test.

### Steady State Compliance Tests

A steady state compliance test is a “static test” where the magnitude, frequency, and phase offset are constant and fixed for the duration of the test. Steady state compliance tests make sure that the UUTs performance is within the range and limitations *IEEE C37.118.1-2011, “Steady State Compliance”*.

When a steady state test is started, the Timing Unit slews the nominally 30 MHz clock frequency to align the 6105A Master Unit phase reference (*Refp*) with the 1 PPS. The clock is set to exactly 30 MHz when alignment is achieved, and the 6105A Master Unit output is at the nominal frequency (50 Hz or 60 Hz) with the L1 Phase voltage at zero degrees (with reference to the 1 PPS). All other voltage and current outputs are aligned with 1 PPS but offset by the phase angles set on the 6105A Master Unit to achieve a very accurate balanced positive sequence output.

All tests begin at 1 PPS. This is zero time in the mathematical model known as *T0*. The time stamp of the start of test (*STU\_T0*) and the time of the positive edge of the Phase Reference (*STU\_TRefp*) are passed to the mathematical model of the 6105A Master Unit output. When the PMU reports, the timestamp of the synchrophasor is used in the mathematical model to calculate the “True” synchrophasor at that time. The two synchrophasors are compared to determine the PMU error.

PMU tests include static signals at frequencies between nominal and up to  $\pm 5$  Hz. This is the maximum range of frequency for any PMU configuration. In non-nominal frequency tests, the Synchrophasor  $0^\circ$  is not always aligned with 1 PPS. This does not matter as long as there is alignment at the start of the test so that the mathematically generated Synchrophasors are correct.

Some Static tests required by the *IEEE C37.118.1-2011* standard include the application of out-of-band interference. These are implemented in the Calibration System by application of Harmonics and Interharmonics. The accuracy of Harmonics and Interharmonics is reported in the 6105A Master Unit calibration certificate.

The steady state compliance tests compare Total Vector Error (TVE), Frequency Error (FE), and Rate of change of Frequency Error (RFE) with these tests:

- **Signal Frequency Range Test** – These tests verify that limits are not exceeded for a range of frequencies across the bandwidth of the UUT. The UUT bandwidth is determined by the PMU configuration.
- **Voltage and Current Signal Magnitude** - These tests verify that the voltage and current signal magnitude is not nominal.
- **Phase Angle** – These tests verify that limits are not exceeded when phase angles are constant or slowly varying.
- **Harmonic Distortion** – These tests verify limits are not exceeded in the presence of harmonics.
- **Out-of-band Interference (Interharmonics)** –These tests verify that limits are not exceeded in the presence of out-of- band interfering signals.

### Dynamic Compliance Tests

A dynamic compliance test type is where the magnitude, frequency, and phase offset vary depending on the type of test. Dynamic compliance tests make sure that the UUTs performance is within the range and limitations in *IEEE C37.118.1-2011 “Dynamic Compliance”*.

The dynamic compliance tests compare TVE, FE and RFE with these tests:

- **Modulation (Measurement Bandwidth)** – These tests verify limits are not exceeded when the input voltage and current are phase modulated and phase and amplitude modulated together. Modulation is achieved by modulating the 30 MHz clock to achieve  $\pm 0.5$  Hz from nominal at up to 5 Hz/s at the 6135A outputs. Testing starts at the 1 PPS to synchronize the mathematical model. Amplitude modulation of up to  $\pm 10$  % at up to 5 Hz/s is applied using the fluctuating harmonics feature of the 6105A Master Unit. The hardware trigger from the STU to the 6105A Master Unit ensures the actual output and mathematical model are aligned.
- **Frequency Ramp** – These tests verify limits are not exceeded when the input frequency is linearly ramped. Frequency Ramp tests vary frequency linearly by up to  $\pm 5$  Hz from nominal at 1 Hz/s. The ramp starts before the start frequency to avoid sudden frequency changes which would cause significant Rate of Change of Frequency Error within the “measurement window”. As with phase modulation the input clock frequency is ramped to change the 6105A Master Unit output frequency. The Calibration System applies a frequency correction factor in the mathematical model to compensate for phase delays in the 6105A Master Unit circuitry and ensures the “True” Synchrophasor is correct. This correction is also applied in phase modulation and static non-nominal frequency tests.
- **Step** – A different set of measures apply to Step tests. These tests verify response time, delay, maximum overshoot/undershoot, frequency response time, and rate of change of frequency response time. Limits are not exceeded when an input magnitude or phase angle step is applied. The criteria for step tests are different to the other types of test. Steps are  $\pm 10$  % Amplitude or  $\pm 10^\circ$  Phase Angle. The parameters measured in step tests are Delay Time, Response Time and Maximum Undershoot /Overshoot. The accuracy of amplitude steps is determined by the 6105A Master Unit performance. The Hardware Trigger from the Timing Unit to the 6105A Master Unit trigger input ensures steps occur at the correct time. The Timing Unit controls phase angle steps and checking this is one of the tests in the User verification process below.



**Standard Compliance Tests File Naming Convention**

The standard compliance tests are saved in a folder named with the compliance test and subtest name (for example, “..\Tests\60Hz\SteadyState\Magnitude”). Inside the folder, each compliance test is named with the primary test parameters in the filename to help visually identify the test parameters for the test. The fundamental test parameters shown in the naming convention are different for each compliance subtest. Though the naming convention is different each compliance test type, all the files use these common naming rules:

- Each test parameter is separated with an underscore “\_”.
- Each letter in the filename represents a specific test parameter.
- Each letter is a decimal place for the parameter (for example, 00F0 is 00.0).

Figures 3-18 through 3-20 illustrate the naming conventions for the steady state and dynamic test subtype.

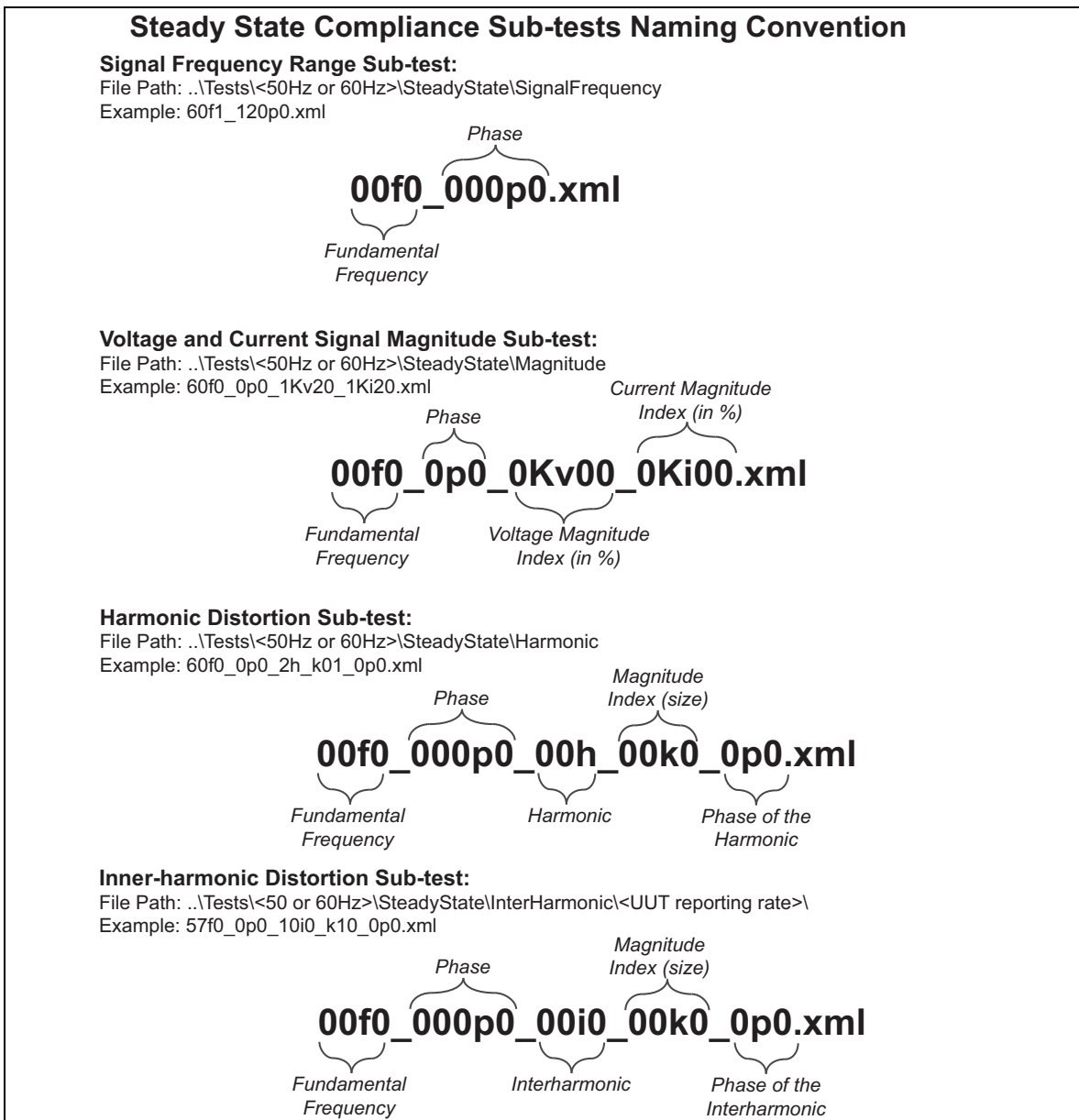

**Figure 3-18. Steady State Compliance Subtest Naming Convention**

gtu063.eps

### Dynamic Compliance Sub-tests Naming Convention

**Modulation Magnitude Sub-test:**

File Path: ..\Tests\<<50Hz or 60Hz>\Modulation\<<Amplitude or Phase or Combined>\  
Example: 60f0\_0p0\_1m7\_a00\_x10.xml

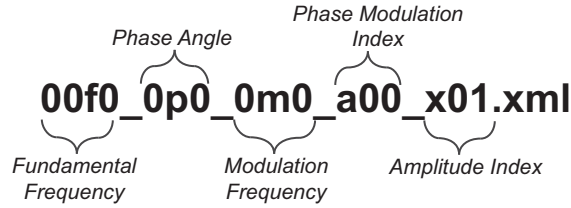

**Frequency Ramp Sub-test:**

File Path: ..\Tests\<<50Hz or 60Hz>\FrequencyRamp  
Example: 65f0\_1r0\_55f0\_0p0.xml

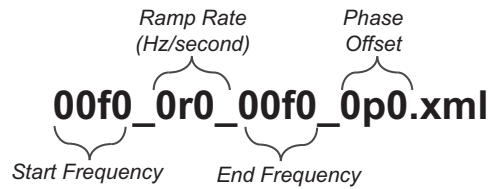

**Step Sub-test:**

File Path: ..\Tests\<<50Hz or 60Hz>\Step  
Example: 60f0\_0p0\_x0\_-10a.xml

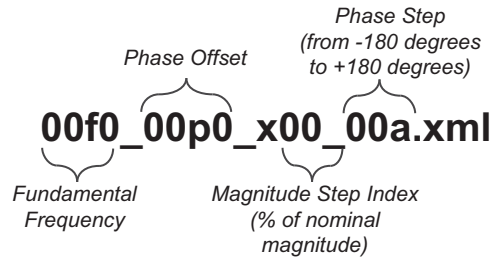

Figure 3-19. Dynamic Compliance Subtest Naming Convention

gtu064.eps

### Latency Sub-tests Naming Convention

**Measurement Latency Sub-test:**

File Path: ..\Tests\<<50Hz or 60Hz>\Latency  
Example: 60f0\_30fs\_m.xml

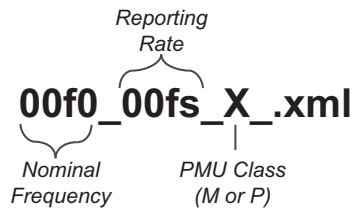
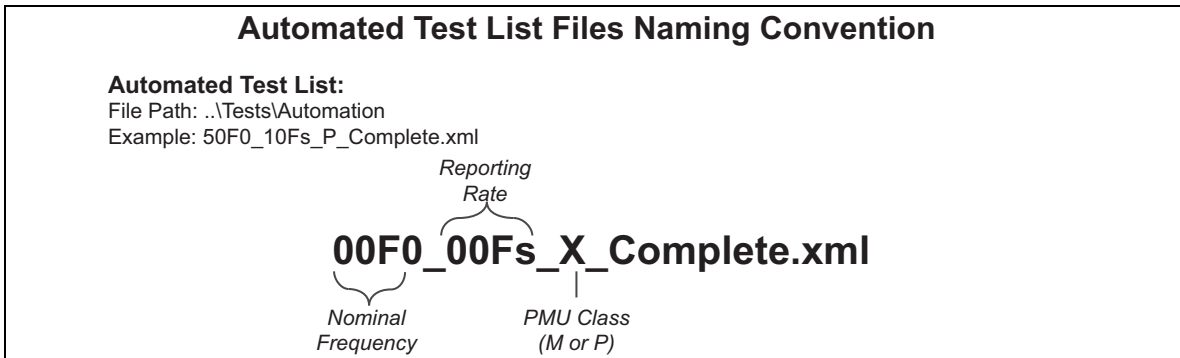

Figure 3-20. Latency Subtest Naming Convention

gtu144.eps

### Automated Test List Files

The automated test list files are saved in “Automated” folder. Figure 3-21 illustrates the automated test list naming convention.



**Figure 3-21. Automated Test List Naming Convention**

### Test Results and Results Files

The PMUCal Software writes test results to a results file in the results folder. It also creates a test log file in the results folder. The Calibration Software saves raw test data for each test completed. For each UUT report analyzed, the raw test data contains:

- Data received from the UUT.
- Reference data representing the Timing Unit signal inputs to the UUT.
- Test parameters which determines the Timing Unit signal input to the UUT.

For more information, refer to “Raw Data Files” in this section.

See the subsequent sections for information on the test results file storage directory, file directory folder structure, and file naming convention.

#### About Result Files and the Active Results File

A test results file contains test results from tests completed on a UUT, thus the results file is saved to the active UUT personality results folder (see Figure 3-26). The results file is an Extensible Markup Language (XML) file and is formatted with placeholders to save the test results for each compliance test and subtest (see Figure 3-23).

Each time the PMUCal Software is used, the operator must choose to make a new results file or save to a results file already made (refer to “Result File Save Options” in this section). After a selection is made, the results file selection window closes and the results file path is shown under the top navigation menu (see Figure 3-22). The file shown in the results file path is referred to as the “active results file”. Each time you run a new test, the data in the active results file is updated with the new maximum values for the test or subtest completed.



**Figure 3-22. Active Results File Path and File**

gtu085.jpg

The active test results file values can be seen on the results screen (see Figure 3-23). The maximum values are used to verify that the performance parameters are in the specified range limits. If test data was not recorded for a test or subtest, then data is not shown for that test. The PMUCal Software continues to update the active results file with maximum values for each test run until a new results file is chosen (refer to “Result File Save Options” in this section).

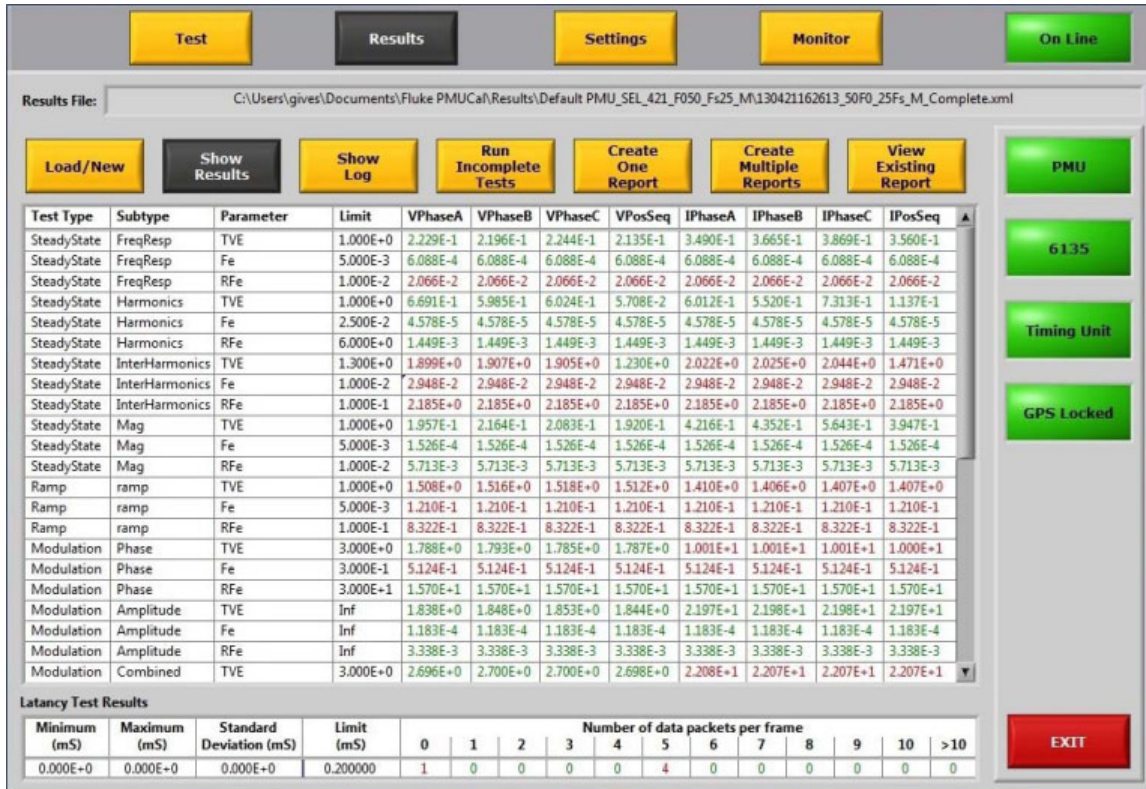
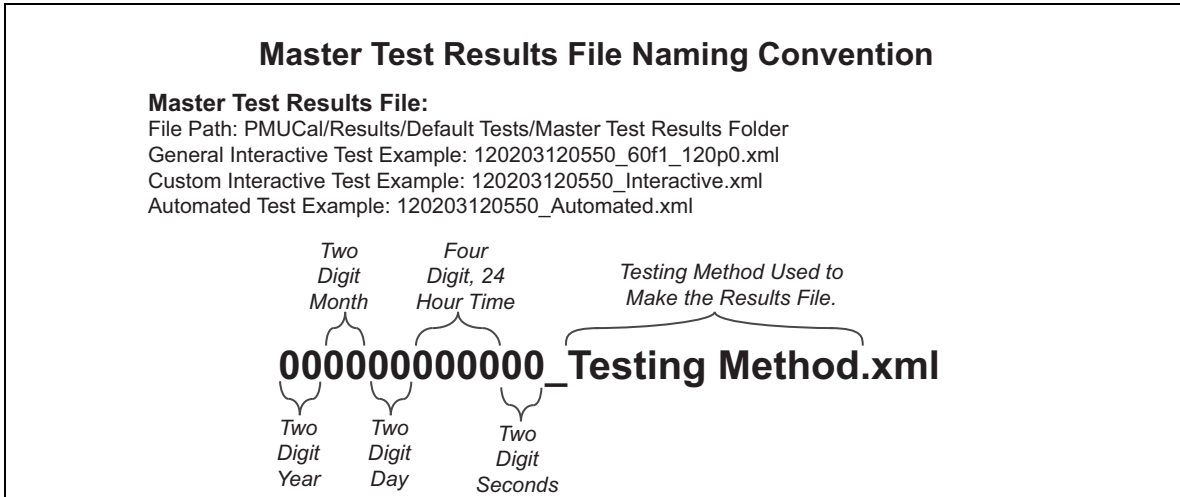

Figure 3-23. Example Test Results

gtu086.jpg

### Results Files Naming Convention

The filename of the test results file shows the date and time when the test was started and what kind of test was completed. Each results file has a timestamp followed by the name of the test method or filename of the test run. Figure 3-24 illustrates the results file naming convention.



**Figure 3-24. Master Test Results File Naming Convention**

### Result File Save Options

After connected to the UUT or the simulator, the result file selection window (see Figure 4-18) automatically opens. The results file selection window supplies you with three buttons to choose where to save the test results.

*Note*

*Each time a test is completed, the maximum test parameter values overwrite the existing values in the results file until a new results file is made or selected.*

Each button will save the test results as follows:

- If **Start a New Results File** (the green button) is clicked, the PMUCal Software makes a new results file. The button shows where the file is to be saved and also the name of the results file.
- If **Continue Using** (the yellow button) is clicked, the Calibration Software uses the last results file that test results were saved to. If a results file was not previously used or the UUT has never been tested before, the button will be disabled and no link will be shown in the path. The button shows where the file is to be saved and also the name of the results file.
- If **Browse and Select an Existing Results File** (the red button) is clicked, the PMUCal Software opens an Windows Load dialog box to navigate to and select a results file.

*Note*

*To prevent mixing test results from another UUT personality and configuration, make sure the correct file is chosen.*

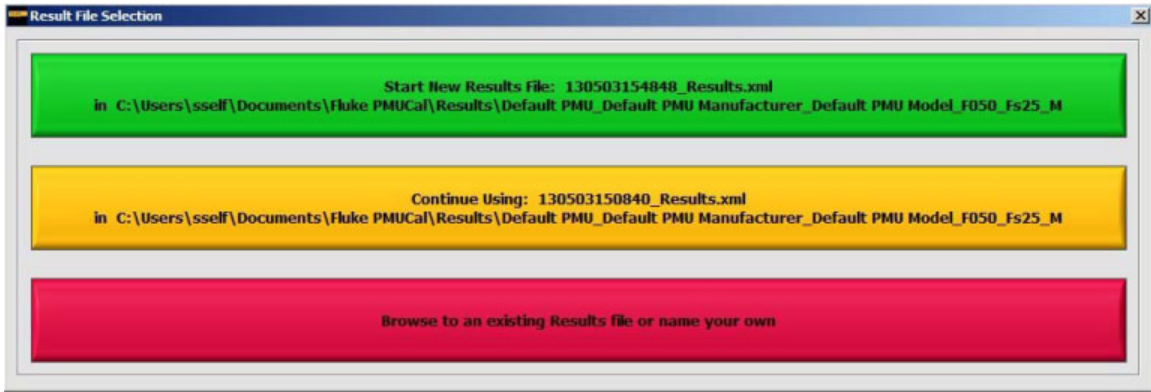

Figure 3-25. Results File Selection Window

gtu080.jpg

### Results File Storage Directory

After the initial installation of the PMUCal Software, it is necessary to choose where to make the top-level folder named **Fluke PMUCal**. Once made, the folder will contain a folder named “results”. The results folder is the storage location for all results files. Figure 3-26 illustrates the folder structure.

#### Note

After installation of the Calibration Software, the location of the top-level PMUCal folder or the results folder can be changed (see “Set Up the File Storage Directory” in Chapter 2).

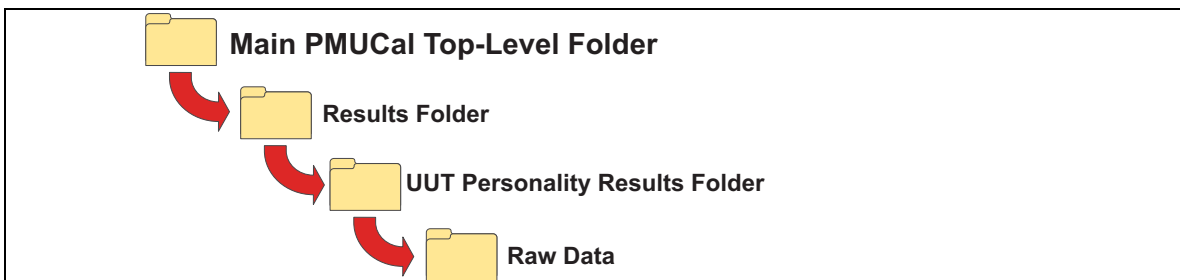

Figure 3-26. Test Results Folder Structure

gtu060.eps

### Raw Data Files

Raw test data is the full set of unedited and unformatted test data files in Comma Separated Values (CSV) format that the system collected from the test. Time-stamped raw test data files are saved to the Raw Data folder inside the UUT personality Results Folder in **\\FlukePMUCal\Results\{PMU Personality Name}**.

### Test Report and Calibration Report

For information on the test report and calibration report, refer to Chapter 7, “Interactive Graphs, Results, and Reports”.

# Chapter 4

## *UUT Calibration Setup*

<b>Title</b>	<b>Page</b>
About this Chapter .....	4-3
Safety Information .....	4-3
General Operation Information .....	4-4
Turn On the Calibration System .....	4-4
Turn Off the Calibration System .....	4-4
Calibration System Warm-up .....	4-4
Connect the Calibration System to a UUT .....	4-4
Prepare the UUT for Calibration .....	4-5
Current Connections .....	4-6
Voltage Connections .....	4-7
UUT Data Cable Connection .....	4-8
GPS Signal Cable Connection .....	4-8
Communicate with the UUT .....	4-9
Set Up a UUT Personality Profile .....	4-11
Configure the UUT Phase Order .....	4-14
UUT Connection Test .....	4-16





## About this Chapter

This chapter supplies information necessary to safely connect the Calibration System to a UUT. Each UUT has unique features that will affect this connection and configuration procedure. Before this procedure is started, read the UUT user documentation to fully understand the operation, limits, and features of the UUT.

For an alphabetical list of terms and abbreviations used in this chapter and manual, see “The Glossary” in Appendix A of this manual.

## Safety Information

### Warning

To prevent possible electrical shock, fire, or personal injury:

- Do not use test leads if they are damaged. Examine the test leads for damaged insulation, exposed metal, or if the wear indicator shows. Check test lead continuity.
- Do not touch voltages >30 V ac rms, 42 V ac peak, or 60 V dc.
- Do not connect to live output terminals. The Product can supply voltages that can cause death. Standby mode is not sufficient to prevent electrical shock.
- Only use probes, test leads, and accessories that have the same measurement category, voltage, and amperage ratings as the Product.
- Do not connect to live output terminals. The Product can supply voltages that can cause death. Standby mode is not sufficient to prevent electrical shock.
- Do not attempt to connect or disconnect any electrical connections to the UUT if the "Client Heartbeat" LED on the front of the Product is flashing Amber. This indicates the product is operating under remote control and outputs may have hazardous voltages present. Always treat the Input/Output Panel connectors, L1, L2, and L3, as if they have hazardous voltages.
- Remove the line power cord from the Product connection panel before making the power connection to the PMU under test.
- Disconnect L1, L2, and L3 voltage and current outputs from the Input/Output Panel before the signal connections to a UUT are connected or disconnected. The Product can be operated remotely so voltage may be connected to the output signal terminals unexpectedly.
- Do not use test leads if they are damaged. Examine the test leads for damaged insulation, exposed metal, or if the wear indicator shows. Check test lead continuity.

## General Operation Information

### Turn On the Calibration System

When the Calibration System is turned on, each system will initialize and connect to the other components in the system automatically. The front panel power switches on the 6135A Units put them into standby mode, but do not completely isolate power. The 6135A can safely be left in standby and will consume a small amount of power unless switched off at the rear panel.

To turn on the Calibration System:

1. Open the front panel access cover on the **Server PC** and push the **Power** button.
2. Push the **Power** button on the rear panel of the **GPS Receiver** (if required).
3. Push the **Power** button on the **6135A/PMU System Timing Unit** front panel.
4. Push the **Power** button on the two **6106A (Auxiliary) L2 and L3 units**. Wait a few minutes then push the **Power** button on the **6105A (Master) L1 unit**. If the internal cooling fan is not heard running inside each unit, check to make sure that the rear power switches are on. Do not operate the unit if the fan is not running.
5. Let the Calibration System warm-up, see “Calibration System Warm-up” in this chapter.

### Turn Off the Calibration System

To turn off the Calibration System:

1. Push the **Power** button on the **6105A (Master) unit**.
2. Push the **Power** button the two **6106A (Auxiliary) units**.
3. Push the **Power** button on the **6135A/PMU System Timing Unit** front panel.
4. Push the **Power** button on the rear panel of the **GPS Receiver** (optional).
5. Open the front panel access cover on the **Server PC** and push the **Power** button.

### Calibration System Warm-up

To guarantee accuracy, the Calibration System must be warmed up 1 hour or more to let the environmentally controlled components become stable.

## Connect the Calibration System to a UUT

Use this section to connect the Calibration System to a UUT for test or calibration. Each UUT has unique features that can change this connection and configuration procedure. Before you start this procedure, read the UUT user documentation to fully understand the limits and features of the UUT.

The basic UUT connection procedure is illustrated in Figure 4-1. This illustration lists the procedure to connect a UUT to the Calibration System. Each topic contains references to helpful information and procedural instructions.

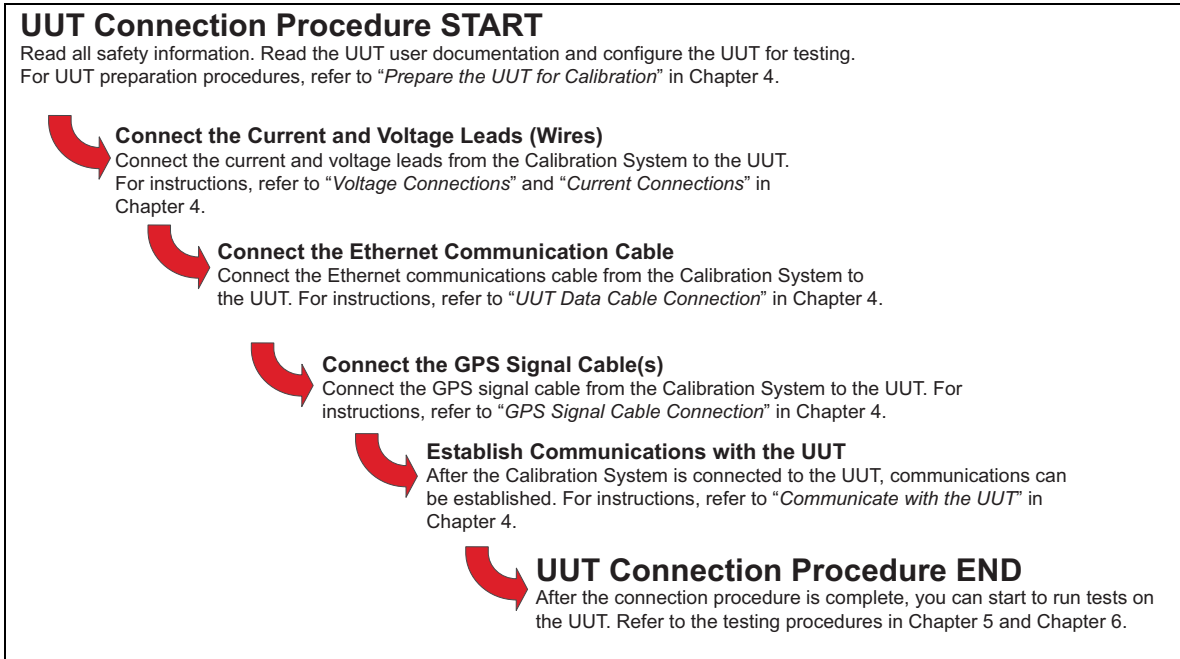

**Figure 4-1. UUT Connection Procedure**

gtu067.eps

**Prepare the UUT for Calibration**

Prepare the UUT for calibration (refer to the UUTs users documentation for instructions):

1. Read the UUT users documentation for information such as how to connect the inputs, turn-on inputs, configure the IP address and subnet-mask, assign or find the UUT ID number, and how to change the UUT configuration.
2. Turn on the communication port on the UUT and set the properties to the IEEE C37.118.2 communication standard (if required).
3. Configure the UUT to have an IP address of **192.92.92.92** and a subnet-mask of **255.255.255.0**.
4. Set the nominal frequency, reporting rate, and class (if configurable) to the values necessary for the calibration procedure.
5. Configure the bypass filters on the UUT for calibration.
6. Configure the current transformer (CT) and potential transformer (PT) turns to a ratio of 1:1.

Prepare the Calibration System:

1. Turn off the Calibration System (refer to “Turn Off the Calibration System” in this Chapter).
2. Collect all cables and connectors necessary to connect the Calibration System to the UUT.

## Current Connections

Connect the current leads from the Calibration System Input/Output Panel to the UUT as follows (refer to Figure 4-2).

### Note

*Most PMUs will have a visual current flow indicator (usually a “sense” or “phasing” dot) above the current input connectors. To prevent inaccurate UUT measurements, make sure to connect the red current wires to the current inputs with the current flow indicator. This will make sure that the current flow is in the same direction for all three current phases.*

1. Connect the **Red** current wire to the **Red Current HI Output**.
2. Connect the **Black** current wire to the **Black Current LO Output**.

On the rear panel of the UUT for each phase in turn:

1. Connect the **Red** current wire to the **Current Input** (input with the current flow indicator).
2. Connect the **Black** current wire to the **Current Input** (input without the current flow indicator).

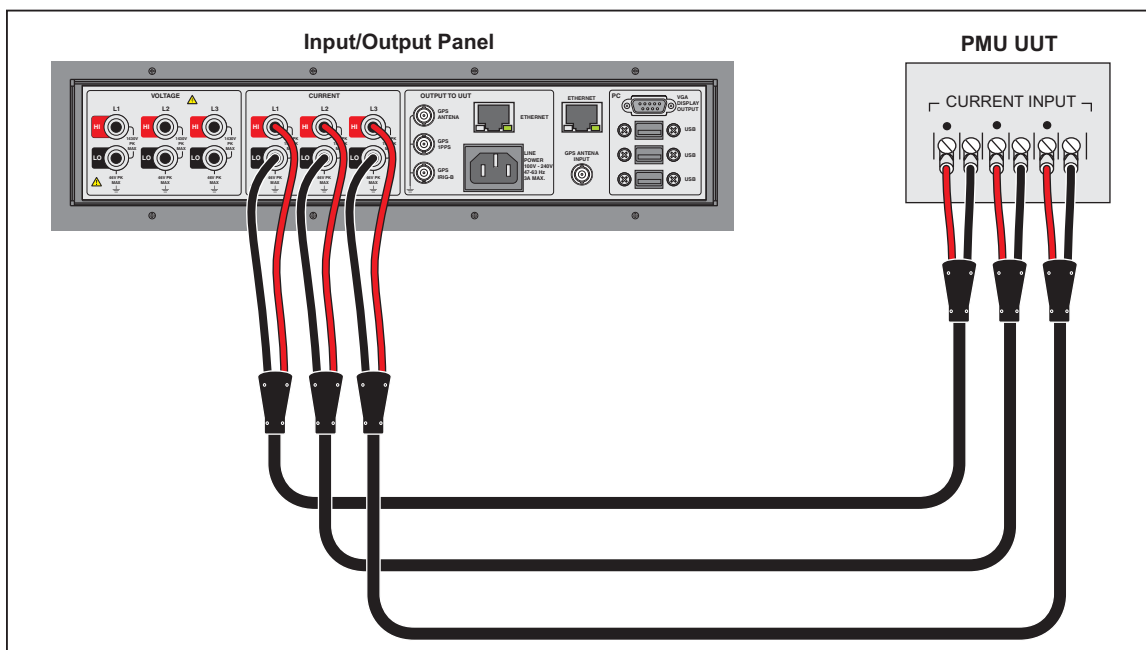

Figure 4-2. Current Connections (Three Sets of Current Shown)

gtu139.eps

### Voltage Connections

Connect the voltage leads from the Calibration System Input/Output Panel to the UUT as follows (refer to Figure 4-3):

*Note:*

*The voltage leads supplied with the system provide 4 wire connection to the front panel of the 6135A should that be required for other applications. For PMU calibration 4 wire connection is not required but for safety all connections should be made as described below.*

1. Connect the **Blue** voltage wire to the **Black Voltage Lo Output**.
2. Connect the **Black** voltage wire into the back of the **Blue** wire connector.
3. Connect the **Brown** voltage wire to the **Red Voltage LO Output**.
4. Connect the **Red** voltage wire into the back of the **Blue** wire connector.

On the rear panel of the UUT for each phase in turn:

1. Connect the **Red** voltage wire to the **Positive Voltage Input**.
2. Connect the **Black** voltage wire to the **Negative Voltage Input, Ground, or Common**.

*Note*

*If the UUT does not have a negative voltage input or ground, you can connect all of the black voltage wires together and put them in the common input terminal on the UUT.*

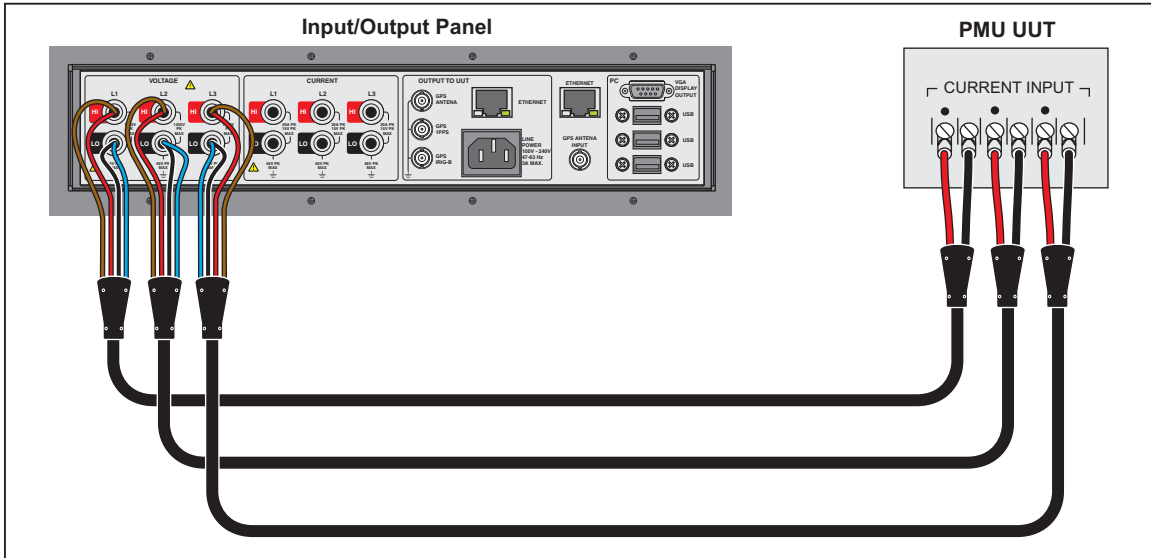

**Figure 4-3. Voltage Connections (Three Sets of Voltage Shown)**

gtu140.eps

### UUT Data Cable Connection

Connect the network Ethernet cable from the Calibration System Input/Output Panel to the UUT as follows (refer to Figure 4-4):

1. On the rear panel of the Server PC, put one end of the **Ethernet Cable** into the left most **Ethernet Port** (see Figure 4-4).
2. On the rear panel of the UUT, put the other end of the **Ethernet Cable** into the **PMU Ethernet Port**.

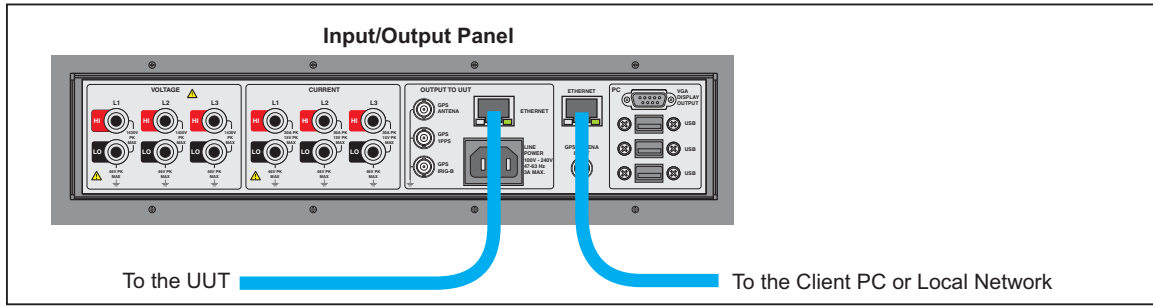

Figure 4-4. The UUT and Server PC Network Cable Connections

gtu141.eps

### GPS Signal Cable Connection

Connect the GPS timing signal cable from the Calibration System Input/Output Panel to the UUT as follows (refer to Figure 4-5):

*Note*

*Some UUTs have internal GPS receivers with a GPS Antenna input. On these, connect the antenna input to the GPS Antenna Out on the Calibrator. For other UUTs, connect the IRIG-B input to the IRIG-B Out of the Calibrator.*

1. On the UUT, connect the **Coax Cable** to the applicable **GPS Input**. The Calibrator has a GPS Antenna Output, an IRIG-B Output, and/or a PPS Output.

*Note*

*Some UUTs that use a IRIG-B input must have a PPS input signal connected. Refer to the UUT user documentation for more information.*

2. On the Calibrator, connect the **Coax Cable** to the **IRIG-B, GPS, or PPS Timing Signal Output**.

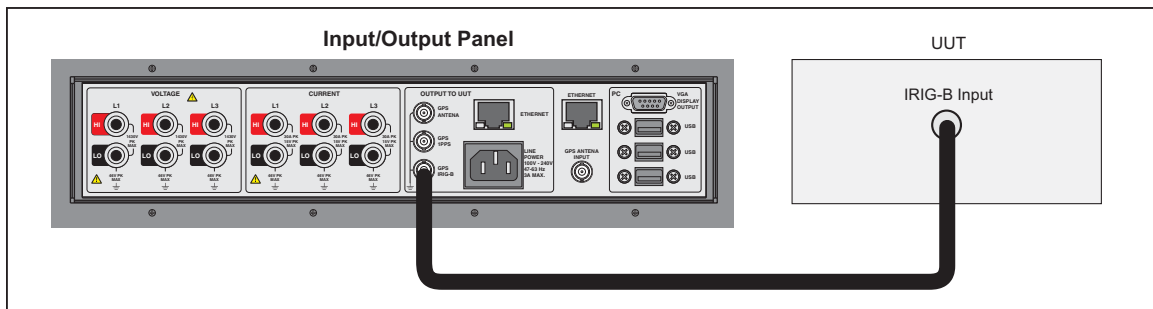

Figure 4-5. Example GPS Connection

gtu142.eps

## **Communicate with the UUT**

To set up communications with the UUT, the Calibration System must be installed and configured (refer to “Install the Calibration System” in Chapter 2). To communicate with the UUT, a UUT personality profile must be configured which includes the UUT phase order. Follow the instructions in the subsequent sections to set up UUT communications.

To communicate with the UUT (refer to Table 4-1):

1. Open the PMUCal Software. When the Calibration Software opens, the startup menu shown in Table 4-1 automatically opens.
2. On the Startup menu, select the **PMU Test Mode** for the Mode of Operation. For information on PMU Test Mode and Simulation Mode, see “PMUCal Software Modes of Operation” in Chapter 4.
3. Type in the Server IP address or Server PC name into the server address field. See Table 4-1 for more information on the Server Network Address selections. The default Server PC settings as supplied by Fluke are: IP address: **192.168.0.250** and PC name: **PMUCal**
4. Select the check box to the left of **Show Tool Tips** to turn on helpful program tooltips (optional).
5. Click **Store as Default** to store the current settings as default settings to use these settings the next time you connect.
6. Click **Continue** to connect to the Server PC.

If a connection to the Server PC is successful, a PMU personality profile dialog opens. If the connection is not successful, a warning dialog box opens.

If a connection cannot be made after two attempts, refer to “Network” in Chapter 8.

Table 4-1. The Startup Menu

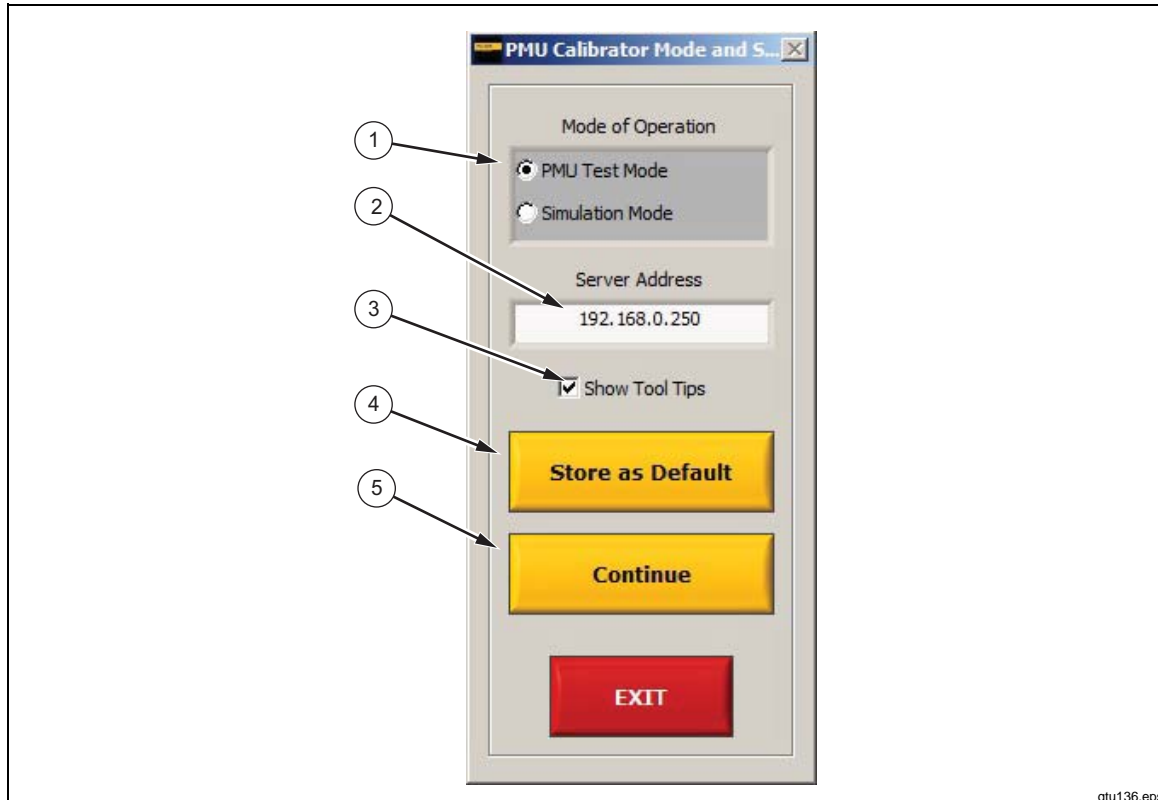

qtu136.eps

Item	Name	Description
①	Mode of Operation	Use to select the mode of operation. The two selections are PMU Test Mode and Simulation Mode. For more information on the modes of operation, see "Modes of Operation" in Chapter 3.
②	Server Address	Manually type in the IP address of the Server PC or the Server PC name. The Server PC is supplied by Fluke with a fixed IP address of: <b>192.168.0.250</b> and a PC name of <b>PMUCal</b> . The entry in this field must reflect any changes to Server PC settings. If the Server is changed to use automatic IP address allocation, (dynamic addressing), there may be a problem connecting to the Server because the IP address might have changed between sessions. Use the Server PC name when there is a risk of this happening. The Server IP address and PC name must be unique.
③	Show Tool Tips	Use to turn on and turn off helpful tool tips. The tool tips show when the mouse pointer hovers over a button or control that has a tool tip available.
④	Store as Default	Use to save the current selections as the default selections. Default selections load when the window opens.
⑤	Continue	Uses the onscreen settings to try to connect to the Server PC.



### **Set Up a UUT Personality Profile**

A UUT personality profile is a file that stores unique information about the UUT (refer to “UUT and Simulator Personality Profiles” in Chapter 3). The UUT personality profile contains information such as the UUT IP address, port number, ID, and the phasor order. Each time a connection is made to the UUT, a UUT personality profile must be loaded or made. Immediately after you click **Continue** on the start menu window, the UUT Personality Configuration Screen opens (see Table 4-2).

A saved UUT personality profile can be updated or changed after you have configured the connection. To change a UUT personality profile, click **Settings** in the main navigation menu and then click **Edit PMU Personality**.

To set up a UUT Personality Profile (refer to Table 4-2):

1. Use the start menu window to connect to the Server PC. The UUT personality window opens automatically after a connection is made.
2. Click **Load** to load a UUT personality profile or make a new UUT personality profile. To make a new UUT personality profile (refer to Table 4-2):
  - a. Type in the **Manufacturer**, **Model**, **Identifier**, and **Serial Number**.
  - b. Select the **Connection Type**.
  - c. Type in **192.92.92.92 for the UUT** IP address (the UUT IP address was configured previously, see “Prepare the UUT for Calibration” in this Chapter).
  - d. Type in the **Port** of the UUT (**4712** is the default UUT port).
  - e. Choose the **ID** number of the UUT.
  - f. Chose the **Version** of C37.118.2 communications protocol in use by the UUT.
3. Click **Save** to save the file for future use (if desired).
4. Click **Connect to UUT and Get PMU Config** to continue. If successful, a message dialog box opens that says “Connected to PMU. Please verify the Phase Order”. Click **OK** to open the Phase Order Configuration tab.
5. Configure the UUT Phase Order. See the next section.

Table 4-2. UUT Personality Configuration Screen

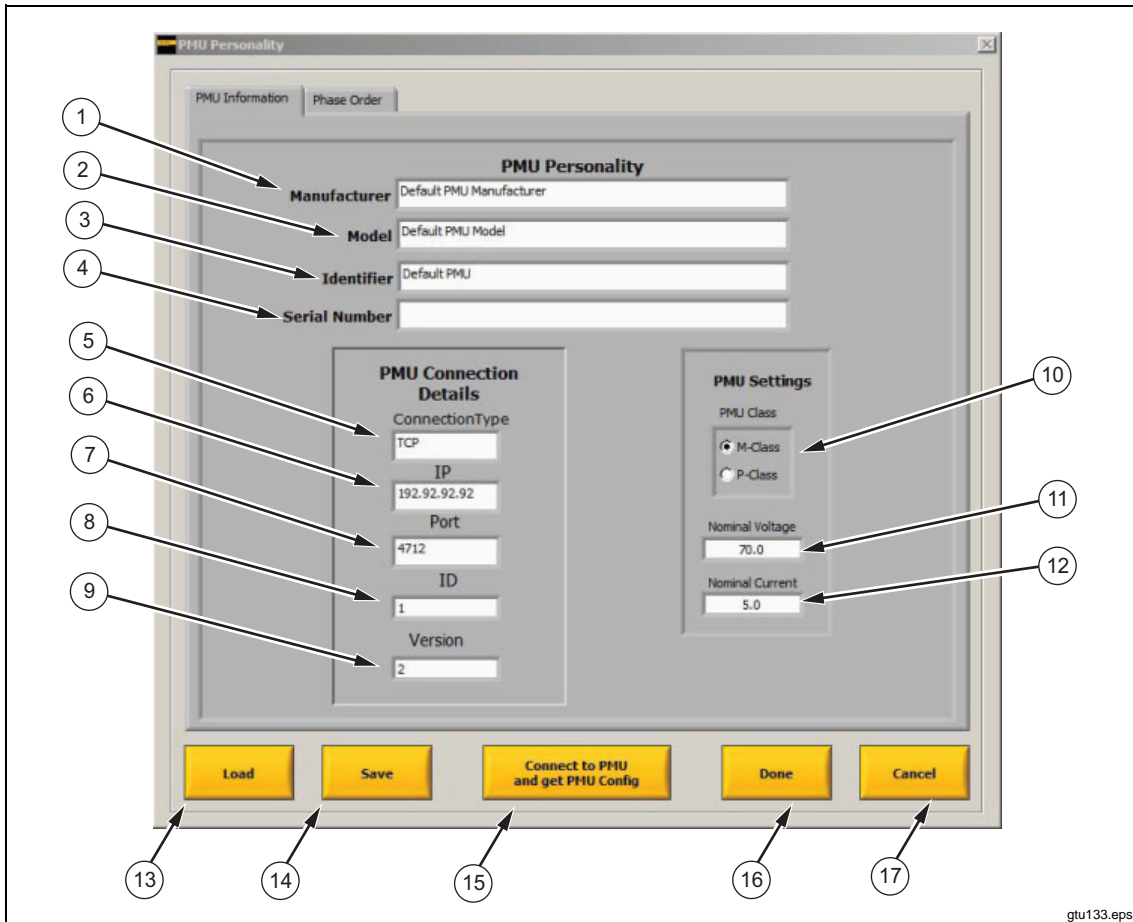

gtu133.eps

Item	Name	Description
①	Manufacturer	Use to type in the name of the company that made the UUT.
②	Model	Use to type in the model number of the UUT.
③	Identifier	Use to type in the user defined identification to assign to the UUT (optional). An identifier could be a company asset identifier for example.
④	Serial Number	Serial number of the UUT
⑤	Connection Type	Use to select the UUTs communication protocol. The communication protocols available are: <ul style="list-style-type: none"> <li>• <b>TCP/IP</b></li> <li>• <b>TCP/UDP</b></li> <li>• <b>UDP</b></li> <li>• <b>UDP Multicast</b></li> </ul>

**Table 4-2. UUT Personality Configuration Screen (cont.)**

Item	Name	Description
⑥	IP Address	Use to type in the IP address of the UUT. Typically, the UUT is configured by the manufacturer with: 192.92.92.92
⑦	Port	Use to type in the UUT port number. Typical PMU port number is 4712.
⑧	ID	Use to type in the unique numerical identifier of the UUT. Each UUT has unique numerical identifier in the UUT configuration. Refer to the UUT users documentation for instructions on how to find out the UUT ID number.
⑨	Version	The version of C37.118.2 communications protocol in use by the UUT. Most UUTs use Version 2.
⑩	PMU Class	Use to set the class of the PMU. The PMU Class is determined by internal settings of the PMU. Contact the PMU vendor to determine internal settings to comply with M class or P class.
⑪	Nominal Voltage	Use to set the nominal voltage. Nominal voltage is determined by internal settings of the PMU. Be sure that the PMU transformer turns ratio is set to 1:1.
⑫	Nominal Current	Use to set the nominal current. Nominal current is determined by internal settings of the PMU. Be sure that the PMU transformer turns ratio is set to 1:1.
⑬	Load	Use to select and load a saved PMU personality profile.
⑭	Save	Use to save the current PMU personality profile.
⑮	Connect to PMU and get the PMU Config	Use to send a request to the UUT to get the UUT configuration information. The UUT Phase Order tab opens with the UUT phase order parameters loaded and ready to be set.
⑯	Done	Close the dialog.
⑰	Cancel	Use to cancel all changes.

### **Configure the UUT Phase Order**

After connected to the UUT, the UUT phase order must be configured. The UUT phase order lets the PMUCal Software know which UUT voltage and current phase inputs are connected to the 6135A Phase A, Phase B, and Phase C terminals. Use the UUT phase order configuration window (see Table 4-3) to manually configure the UUT phase order.

#### *Notes*

*If you change a UUT configuration parameter such as the reporting rate or nominal frequency, you must use the PMU personality profile dialog to get the UUT configuration again.*

*A saved UUT phase order can be updated or changed after you have configured the connection. To change a UUT phase order, click Settings in the main navigation menu and then click Edit PMU Personality.*

To set the UUT phase order (refer to Table 4-3):

1. Click on the UUT Phase Input combo box and select the UUT phase input. Repeat for each UUT phase input.

#### *Note*

*The UUT phasor names and order for the voltage and current phase inputs are unique to each UUT model and often can be changed in the UUT configuration. Some phasor names can be easily understood while some are difficult. To prevent a phase mismatch, refer to the UUTs users documentation for the UUTs phasor names and information.*

2. Click **Save** to save the file for future use (if desired).
3. Click **Done** to continue.

Table 4-3. PMU Phase Order Screen

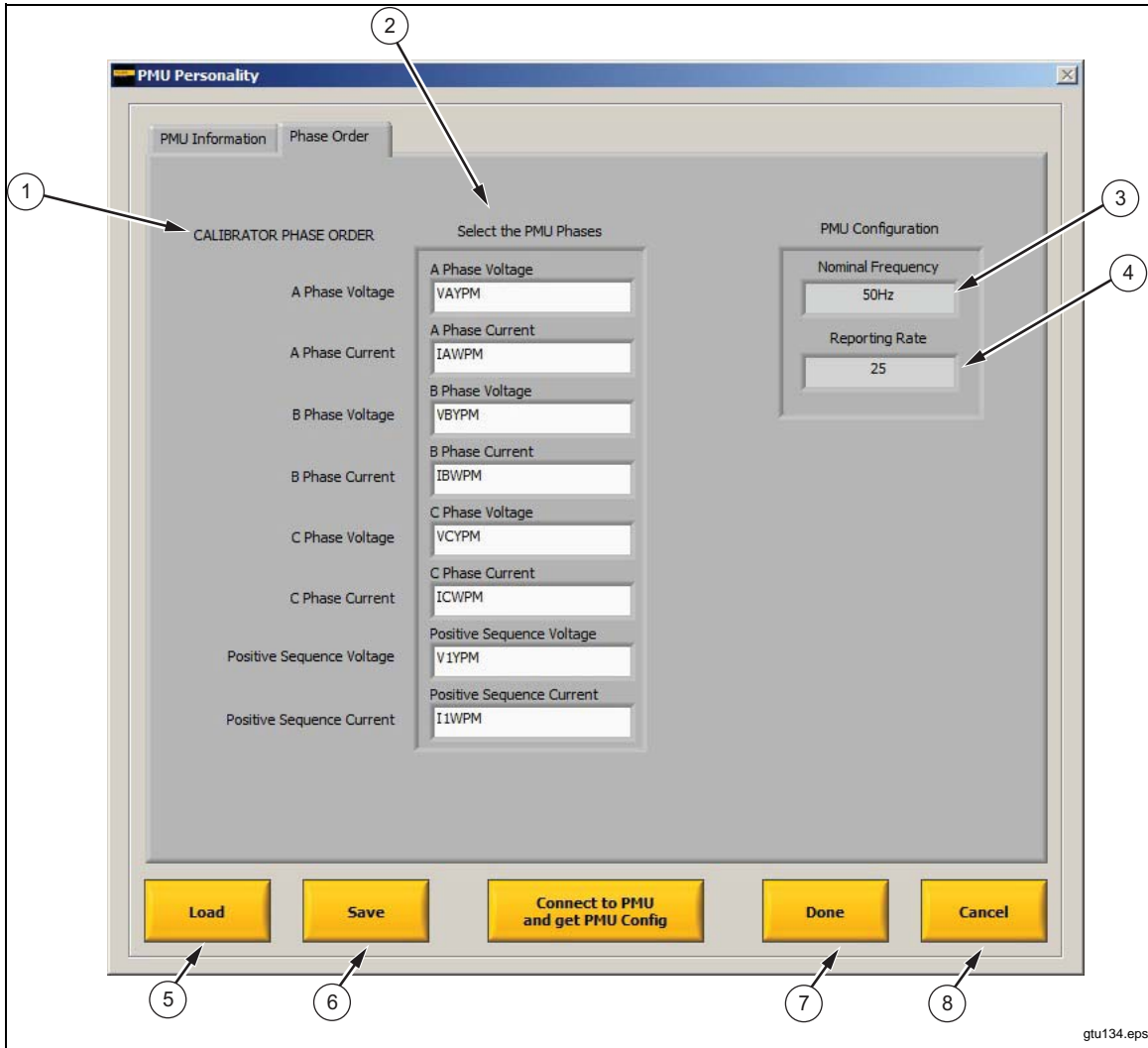

Item	Name	Description
①	Calibrator Phase Order List	Calibration System phase names (Phase A, Phase B, Phase C, and the Positive Sequence inputs).
②	PMU Phase Order	Use to select which UUT Phase input corresponds with the Timing Unit System phases. When <b>Connect to UUT and Get UUT Configuration</b> is clicked, the UUT transmits the phase input names to the PMUCal Software. The drop-down combo box populates with the phase names from the UUT.
③	Nominal Frequency	Nominal Frequency setting of the UUT as reported by the UUT.
④	Reporting Rate	Reporting Rate setting in frames per second of the UUT as reported by the UUT.
⑤	Load	Use to select and load a saved UUT personality profile.
⑥	Save	Use to save the current UUT personality profile.
⑦	Done	Close the dialog.
⑧	Cancel	Use to cancel all changes and go to the startup menu window.

## UUT Connection Test

After a connection to the UUT is made, run a default steady state test to make sure all UUT connections are made correctly as follows:

1. Click **Test** in the top **Navigation Menu**.
2. In **Interactive Testing**, click **Customize and Run Single Tests**.
3. Click on **Run Test** to run a default steady state test on the connected UUT as shown in Figure 4-6.

### Note

*The Input Frequency should match the Nominal Frequency set in the PMU Personality.*

The screenshot displays the 'Test Menu' interface. At the top, the 'General Parameters' section includes a 'Test Type' dropdown set to 'Steady State'. Below this, the 'PMU Configuration and Settings' area contains fields for 'Nominal Frequency' (50), 'Nominal Voltage' (70.0), 'Reporting Rate' (25), 'Nominal Current' (5.0), and 'PMU Class' (M-Class selected). A 'Test Timing' box shows 'Test Duration' set to 5 seconds. A row of buttons includes 'Steady State Tests' (highlighted), 'Frequency Ramp Tests', 'Modulation Tests', 'Step Tests', 'Latency Test', and 'Load Defaults'. The 'Test Parameters' section features 'Input Frequency' (50.0 Hz) and 'Phase Shift' (0 deg) spinners, 'Voltage Magnitude Index' (100 %) and 'Current Magnitude Index' (100 %) spinners, a 'Harmonic' table with columns for Number, Phase (degrees), and Index (%), and an 'Interharmonic' section with 'Frequency' and 'Index (%)' spinners. On the right side, a vertical stack of buttons includes 'Load', 'Run Test', 'Simulate', 'Save', and 'Exit'.

Figure 4-6. Test Menu

gtu122.jpg

- Plot voltage and current for **Phases A, B, and C**. Plot **TVE, Phase Error, Magnitude Error, Frequency Error** and **ROCOF Error** as shown on the Plot Configuration Dialog shown below.

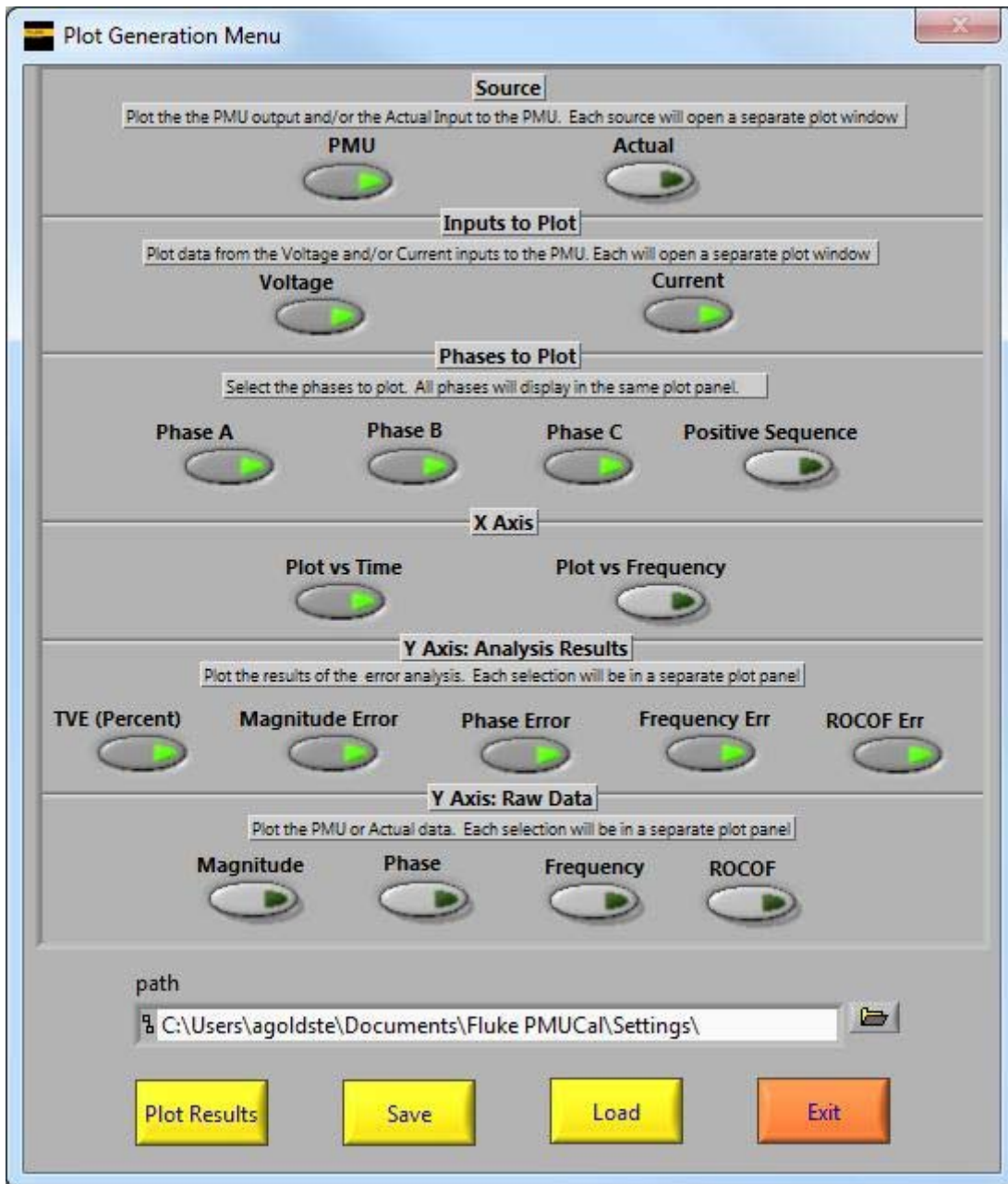

Figure 4-7. Plot

gtu150.jpg

- Look at the plots for both voltage and current. Check the Magnitude Error and Phase Error plots to make sure all UUT phases are connected correctly to the 6135A.

*Note*

*Common issues are incorrect phase order in the PMU Personality or incorrectly connected voltage or current phase inputs. Look for 120 degree or 180 degree phase errors indicating swapped phase order or reversed red/black input connections.*



In the Panel0 plot in Figure 4-8, Panel0 gives an indication of how the phase error should look. Note that the panels are self-scaling and the visual representation made be somewhat different. Check the vertical scale spans less than 0.5 degrees.

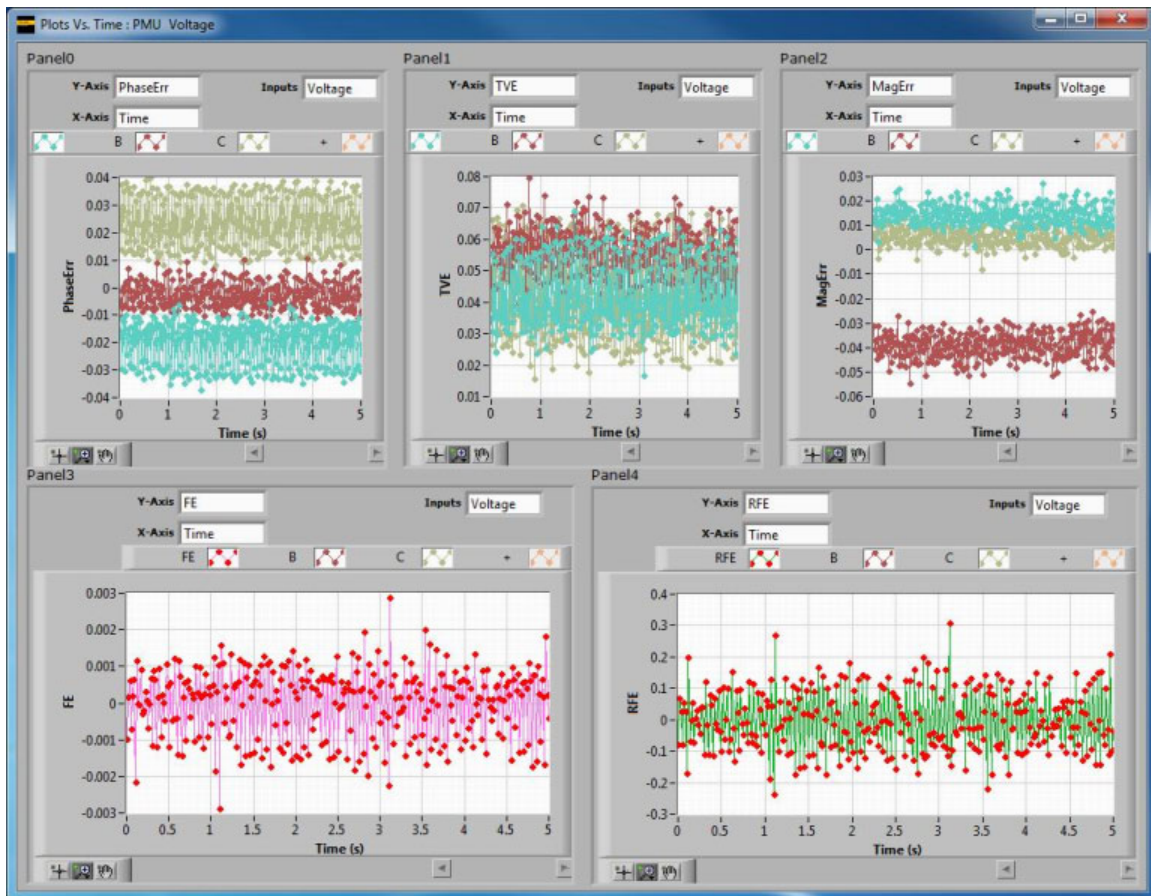

Figure 4-8. Voltage Phases Correct

gtu133.jpg



In the Panel0 plot in Figure 4-9, the phase error for current phase B in Panel0 is 120 degrees the current phase C is -120 degrees. This indicates that these two phases are swapped. This could be a problem with the current wire connections but it could also be a mistake in the Phase order in the PMU Personality. Check the connections and the phase order and repeat the connection test until the plots match Figure 4-9.

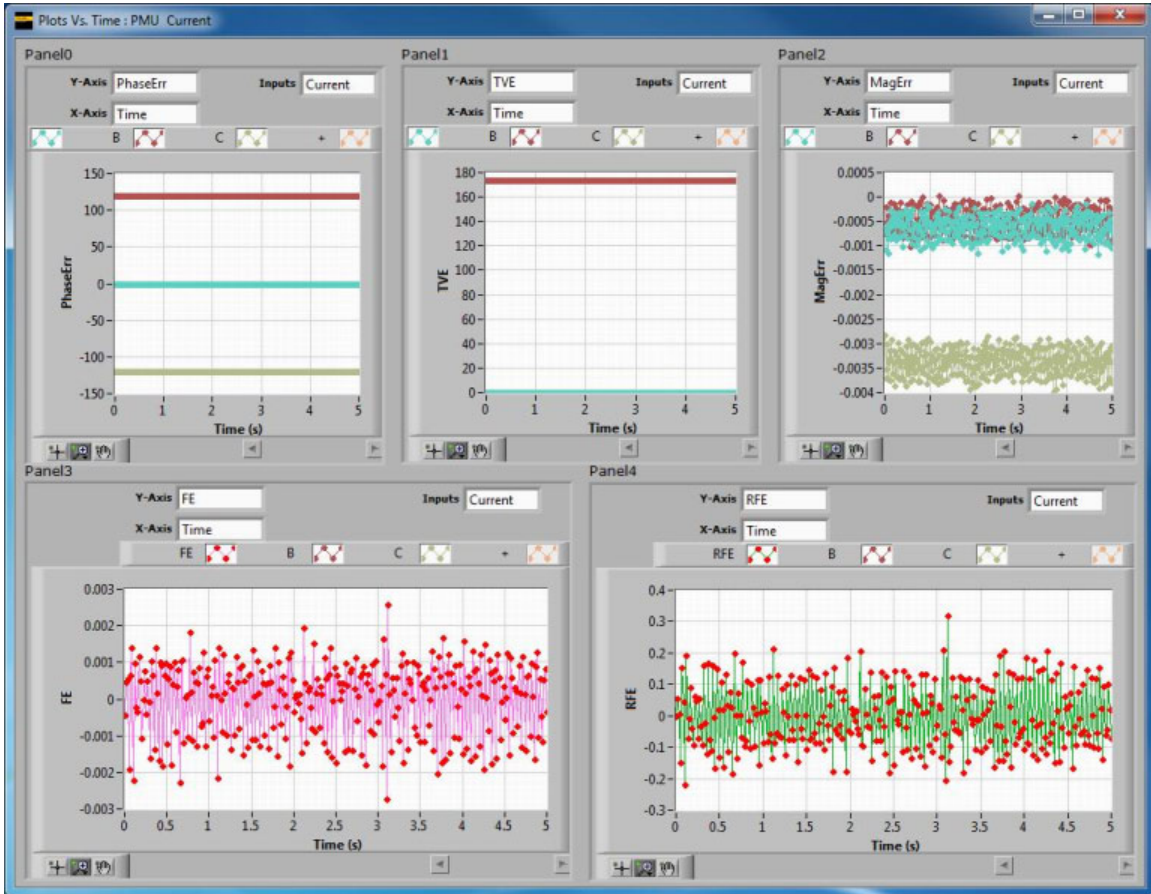

Figure 4-9. Problem - Voltage Phases Swapped

gtu151.jpg

In Panel2 plot in Figure 4-10, Panel2 shows a Magnitude error of 70 volts on the phase b voltage channel. The TVE for phase B is 100%. These inaccuracies indicate that the voltage input is unconnected.

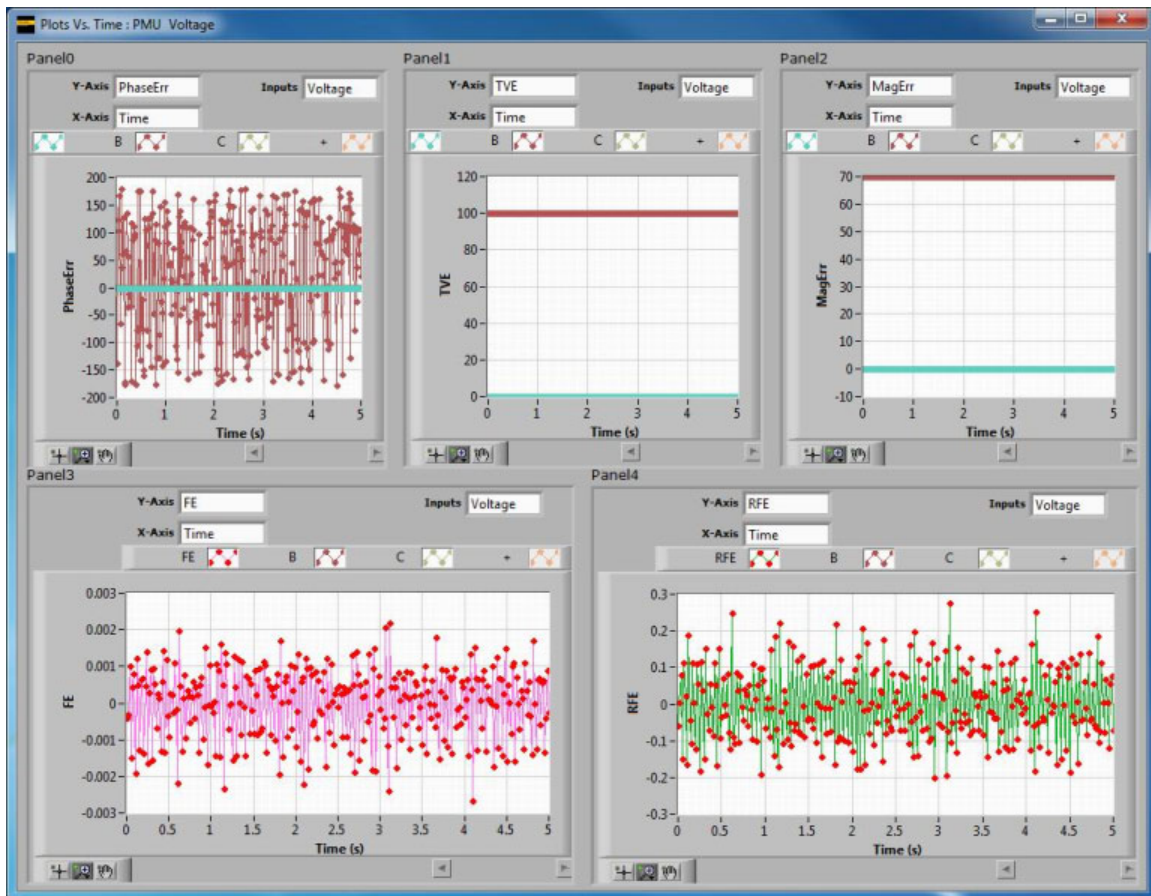

Figure 4-10. Problem - Voltage Phase B is Not Connected

gtu137.jpg

In the Panel1 plot in Figure 4-11, Panel1 shows how the phase error should look. In the Panel1 plots in Figure 4-12, Panel1 shows approximately 100% TVE for all three current phases. The voltage phases are also 100% TVE. This could be an indication that the 6135A forced all the outputs off because of a problem with the voltage and current connections to the UUT. If you are not testing the current inputs and did not connect them to the UUT, then you must set the Nominal Current to 0 in the PMU Personality dialog. If it is not set, the 6135A forces all outputs off when it senses an overvoltage condition on the current outputs.

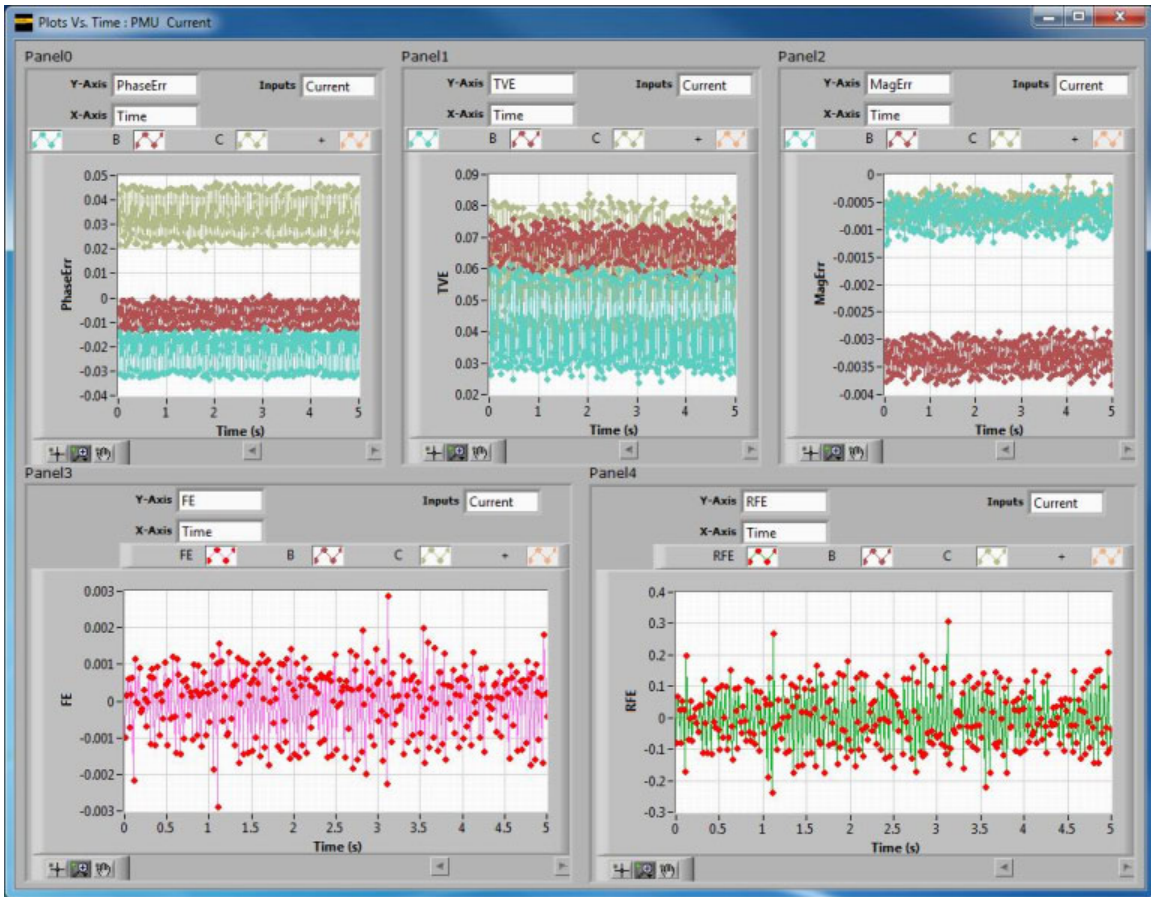
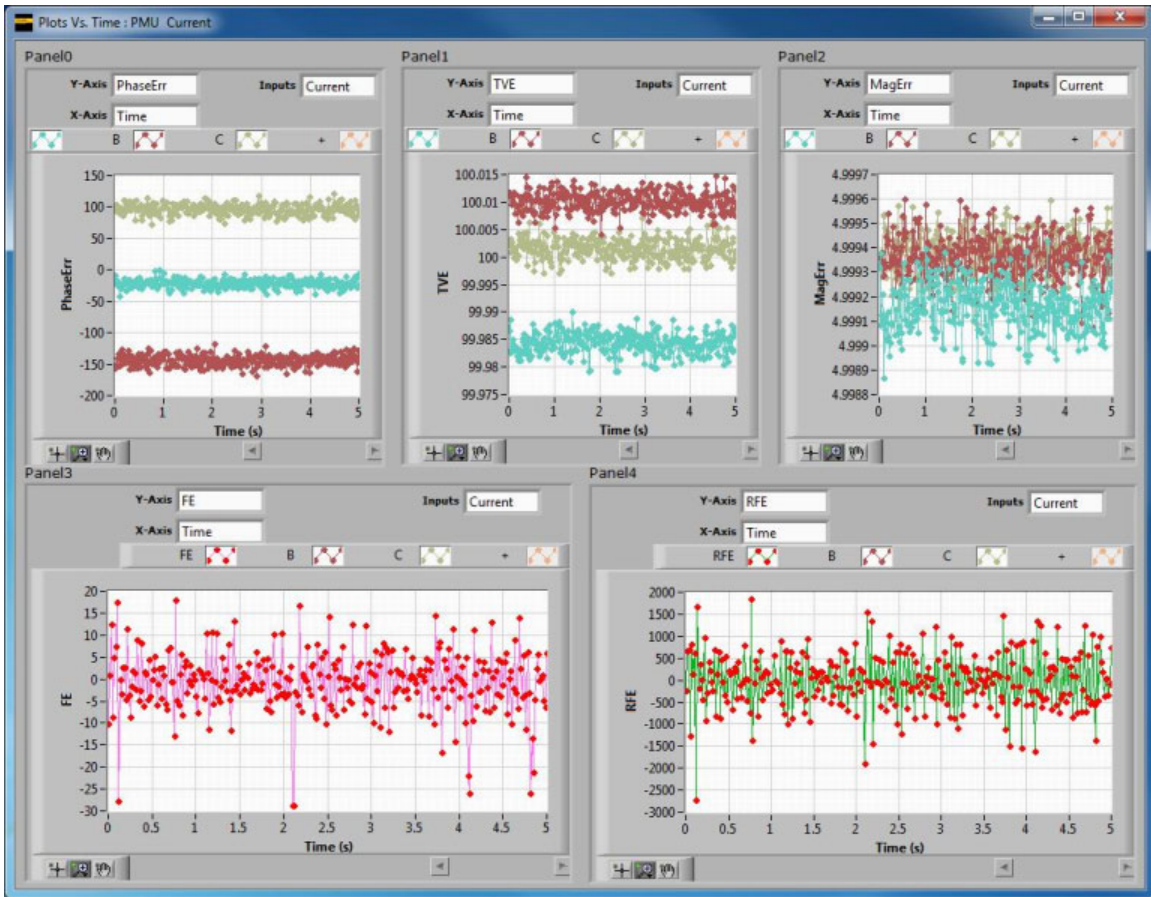

Figure 4-11. Current Phases Correct

gtu136.jpg



gtu135.jpg

Figure 4-12. Problem - All Outputs Forced Off

# **Chapter 5**

## ***Automated Testing***

<b>Title</b>	<b>Page</b>
About this Chapter .....	5-3
Automated Testing Overview .....	5-3
Getting Started .....	5-3
Run an Automated Test .....	5-4
Incomplete Tests .....	5-6
Make a New Automated Test .....	5-8



## **About this Chapter**

This Chapter supplies instructions on how to do an automated test on a UUT. All procedures in this chapter assume that a UUT is connected and configured. If the UUT is not connected and configured, refer to Chapter 4.

For an alphabetical list of terms and abbreviations used in this chapter and manual, see “The Glossary” in Appendix A of this manual.

## **Automated Testing Overview**

To do an automated test, the PMUCal Software uses an automation list in XML format. The automated list file is a sequential “playlist” of XML test files. When an automated test is executed, the PMUCal Software automatically starts and finishes the tests in the order they are listed in. The automated list can be changed and saved as required. For more information see “Make a New Automated Test” in this chapter.

## **Getting Started**

To get started with automated testing, a standard automated list can be loaded or you can edit an automated list to fit your calibration requirements.

If a test cannot be completed or an error occurs when run, the PMUCal Software skips the test and logs the error in the results log. When the test is complete, the tests that did not complete are recorded as “Failed” in the test log in the Results menu. Directly from the results menu, the tests that did not complete can be run again. After the tests are complete, the results file and log will be updated with the appropriate results.

Use the procedures in the subsequent sections to do an automated test.



## Run an Automated Test

To run an automated test:

1. Use the instructions in Chapter 4 to prepare the UUT for test and calibration.
2. Click **Test** in the top **Navigation Menu**.
3. In **General Interactive Testing**, click **Run Automated Test**. A Windows Load dialog box opens (see Figure 5-1).

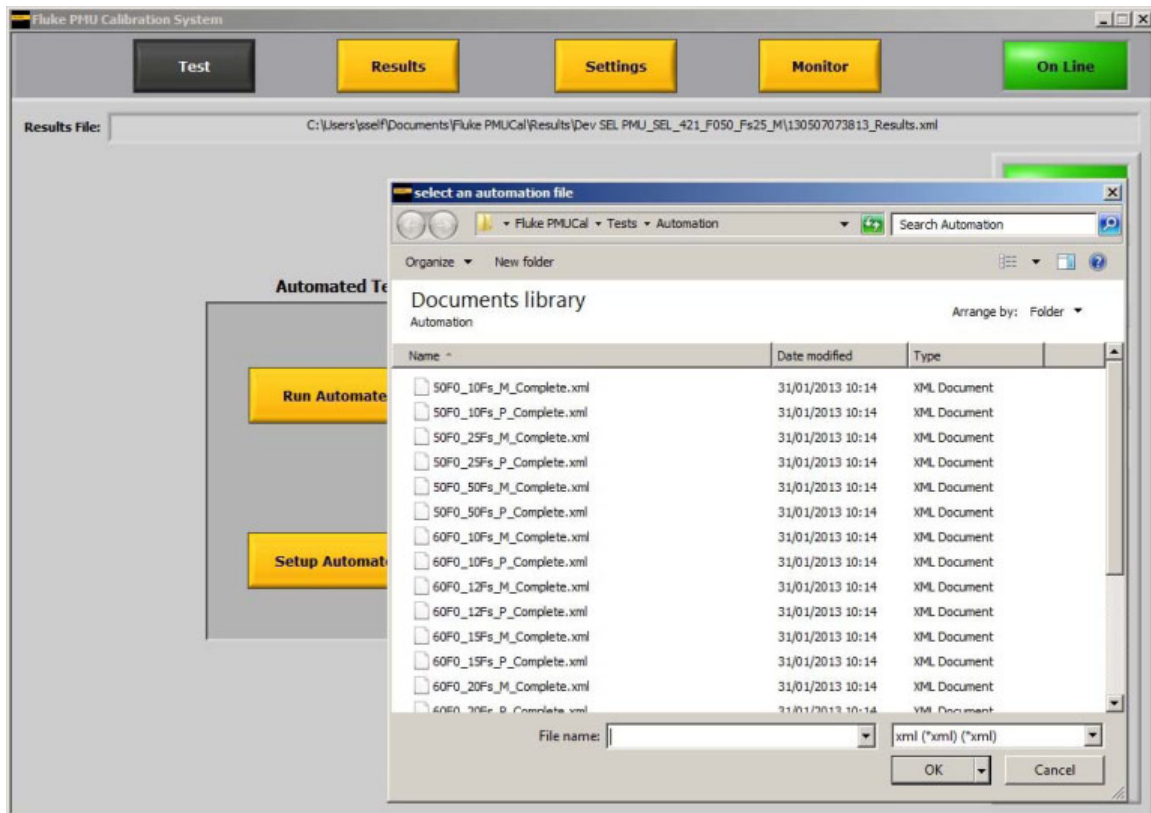

Figure 5-1. Load Automated Test

gtu106.jpg

4. Select an automated test to run then select **OK** (refer to “Automated Test List Files” in Chapter 4 for test file information). After **OK** is selected, the result file selection window opens.
5. Make a selection on how to save the automated test results (see Figure 5-2). After a selection is made, the test status window opens and the automated test immediately starts.

### Note

*If you select “Continue Using” or “Browse to an Existing...” the results from the automated test will overwrite the results in the file.*



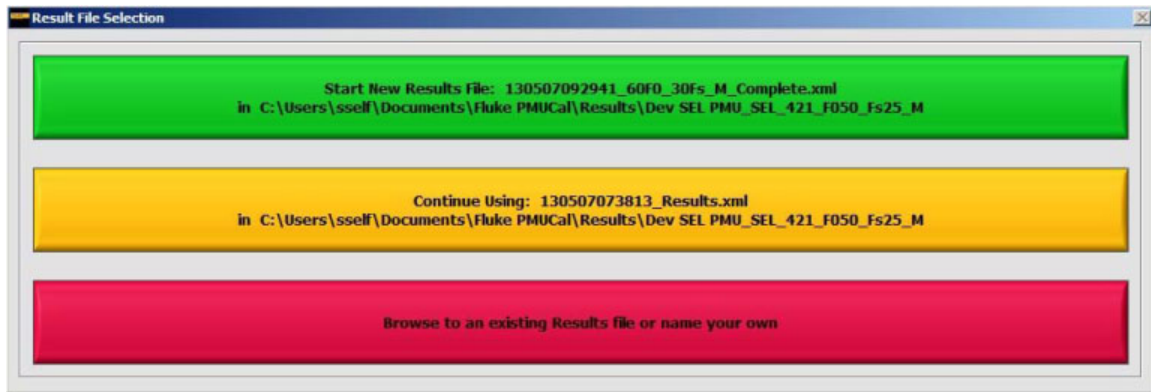

Figure 5-2. Results File Selection

gtu107.jpg

6. Monitor the test status screen as the automated test runs (see Figure 5-3).

*Note*

*If “Skip Current Test” is clicked, the current test is stopped and the next test in the sequence is started. After all of the sequenced tests are complete, the tests that were skipped can be completed. Refer to “Complete Skipped Tests” in this chapter.*

*If you select “Abort All Tests”, the automated test is aborted.*



Figure 5-3. Test Status Window

gtu108.jpg

7. After the test is complete, click on **Results** in the top **Navigation Menu** then click **Show Log** to open the test log (see Figure 5-5).
8. Look in the **Status** column and make sure all tests show “Pass” or “Fail”. If there are tests that show “Error”, “Skipped”, or “Cancelled”, use the instructions in “Incomplete Tests” to complete the incomplete tests.

## Incomplete Tests

After the automated test is complete, use the results log to complete incomplete tests. An incomplete test is defined as a test that has a status of “Cancelled”, “Skipped”, or “Error” on the log.

To complete skipped automated tests:

*Note*

*Skip to step 5 if you already have the applicable Results file loaded.*

1. Prepare the UUT for test and calibration (use the instructions in “Prepare the UUT for Calibration” in Chapter 5).
2. Click **Results** in the top **Navigation Menu**.
3. Click **Load/New** to load the PMU Personality of the PMU. The results file selection menu opens.
4. Use the selections to load the results file that contains the results for the automated test that was done on the UUT.

*Note*

*The results files are marked with time stamps to identify when the results file was made (refer to “Result Files Naming Convention” in Chapter 3). In addition to the result file time stamp, Date Modified column in the load dialog box can be used to find a recently modified results file (see Figure 5-4).*

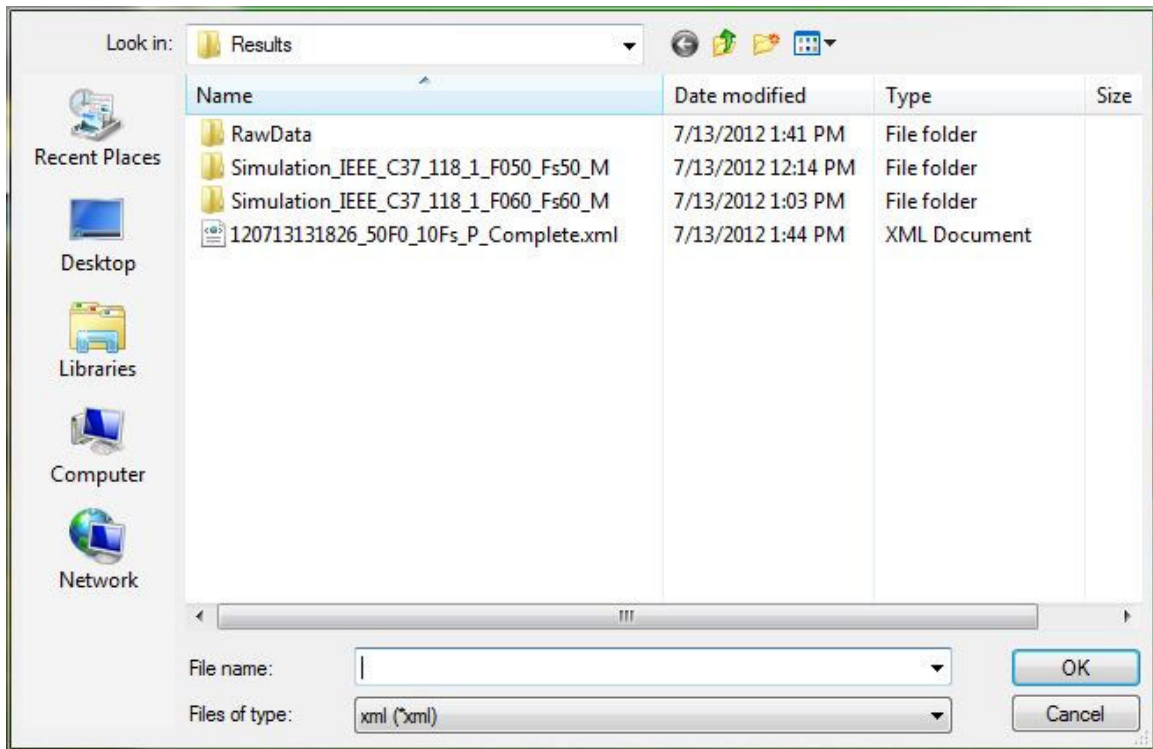

Figure 5-4. Load Results File Dialog Box

gtu110.jpg

5. Click **Results** in the top **Navigation Menu**.
6. Click **Show Results** to view the skipped or incomplete tests.

- Click **Run Incomplete Tests** to run all of the incomplete tests.

*Notes*

After “Run all Incomplete Tests” is clicked, the PMUCal Software runs all the tests with an incomplete status of “Cancelled”, “Failed”, or “Error”. After the test is finished, the test statuses refresh. If a test still shows “Failed” or “Error,” it is possible that the test parameters are out of range for the UUT. To resolve this issue and adjust the parameters, click on the test name to modify the test settings. A test with a “pass” status can be modified the same way, but the PMUCal Software will not run the test again unless it has an incomplete status.

If there are no skipped or incomplete tests to run, a dialog box opens that says “There are no Skipped or Aborted test files to run”.

**⚠ Caution**

To prevent inaccurate test results, never change the UUT configuration after you start an automated test and do not change the UUT configuration to pass a single test. If a test does not pass, use the plots or click on “Edit” to run it as an interactive test to troubleshoot why the test fails. A test failure indicates that the UUT is not in accordance with the performance parameters found in IEEE C37.188.1.

TimeStamp	Status	Test Name (click name to edit)	Raw Data File	Action
20120713133019	Fail	50f2_-180p0	RawData\SteadyState\20120713133019_50f2_-180p0	Plot
20120713133032	Fail	50f2_0p0	RawData\SteadyState\20120713133032_50f2_0p0	Plot
20120713133045	Fail	49f8_0p0	RawData\SteadyState\20120713133045_49f8_0p0	Plot
20120713133059	Error	50f0_0p0_10h_k01_0p0	TestBase.lvclass:RangeCheck.vi<ERR> Test Values Out of Range: <SIF	Edit
20120713133100	Error	50f0_0p0_11h_k01_0p0	TestBase.lvclass:RangeCheck.vi<ERR> Test Values Out of Range: <SIF	Edit
20120713133100	Error	50f0_0p0_12h_k01_0p0	TestBase.lvclass:RangeCheck.vi<ERR> Test Values Out of Range: <SIF	Edit
20120713133101	Error	50f0_0p0_13h_k01_0p0	TestBase.lvclass:RangeCheck.vi<ERR> Test Values Out of Range: <SIF	Edit
20120713133101	Error	50f0_0p0_14h_k01_0p0	TestBase.lvclass:RangeCheck.vi<ERR> Test Values Out of Range: <SIF	Edit
20120713133102	Error	50f0_0p0_15h_k01_0p0	TestBase.lvclass:RangeCheck.vi<ERR> Test Values Out of Range: <SIF	Edit
20120713133103	Error	50f0_0p0_16h_k01_0p0	TestBase.lvclass:RangeCheck.vi<ERR> Test Values Out of Range: <SIF	Edit
20120713133103	Error	50f0_0p0_17h_k01_0p0	TestBase.lvclass:RangeCheck.vi<ERR> Test Values Out of Range: <SIF	Edit
20120713133104	Error	50f0_0p0_18h_k01_0p0	TestBase.lvclass:RangeCheck.vi<ERR> Test Values Out of Range: <SIF	Edit
20120713133104	Error	50f0_0p0_19h_k01_0p0	TestBase.lvclass:RangeCheck.vi<ERR> Test Values Out of Range: <SIF	Edit
20120713133105	Error	50f0_0p0_20h_k01_0p0	TestBase.lvclass:RangeCheck.vi<ERR> Test Values Out of Range: <SIF	Edit
20120713133105	Error	50f0_0p0_21h_k01_0p0	TestBase.lvclass:RangeCheck.vi<ERR> Test Values Out of Range: <SIF	Edit
20120713133106	Error	50f0_0p0_22h_k01_0p0	TestBase.lvclass:RangeCheck.vi<ERR> Test Values Out of Range: <SIF	Edit
20120713133107	Error	50f0_0p0_23h_k01_0p0	TestBase.lvclass:RangeCheck.vi<ERR> Test Values Out of Range: <SIF	Edit
20120713133107	Error	50f0_0p0_24h_k01_0p0	TestBase.lvclass:RangeCheck.vi<ERR> Test Values Out of Range: <SIF	Edit
20120713133108	Error	50f0_0p0_25h_k01_0p0	TestBase.lvclass:RangeCheck.vi<ERR> Test Values Out of Range: <SIF	Edit
20120713133108	Error	50f0_0p0_26h_k01_0p0	TestBase.lvclass:RangeCheck.vi<ERR> Test Values Out of Range: <SIF	Edit
20120713133109	Error	50f0_0p0_27h_k01_0p0	TestBase.lvclass:RangeCheck.vi<ERR> Test Values Out of Range: <SIF	Edit
20120713133109	Error	50f0_0p0_28h_k01_0p0	TestBase.lvclass:RangeCheck.vi<ERR> Test Values Out of Range: <SIF	Edit
20120713133110	Error	50f0_0p0_29h_k01_0p0	TestBase.lvclass:RangeCheck.vi<ERR> Test Values Out of Range: <SIF	Edit
20120713133110	Fail	50f0_0p0_2h_k01_0p0	RawData\SteadyState\Harmonic\20120713133110_50f0_0p0_2h_k01_0	Plot
20120713133124	Error	50f0_0p0_30h_k01_0p0	TestBase.lvclass:RangeCheck.vi<ERR> Test Values Out of Range: <SIF	Edit

Figure 5-5. Test Status Log Example

gtu112.jpg

## Make a New Automated Test

The Calibration System comes with a full set of automated test files to fully calibrate a UUT to the limits in C37.118.1 - 2011. These files can be used as templates for special user defined test sequences. Individual tests can be modified or constructed using the Customize and Run Single Tests feature described in Chapter 6.

To make a new automated test sequence of already existing individual tests:

1. Click **Test** in the top **Navigation Menu**.
2. Click **Setup Automated Test** to open the Setup Automated Test window.
3. Use the buttons on the menu to set up the automated test sequence (see Table 5-1).

Table 5-1. Setup Automated Test Window

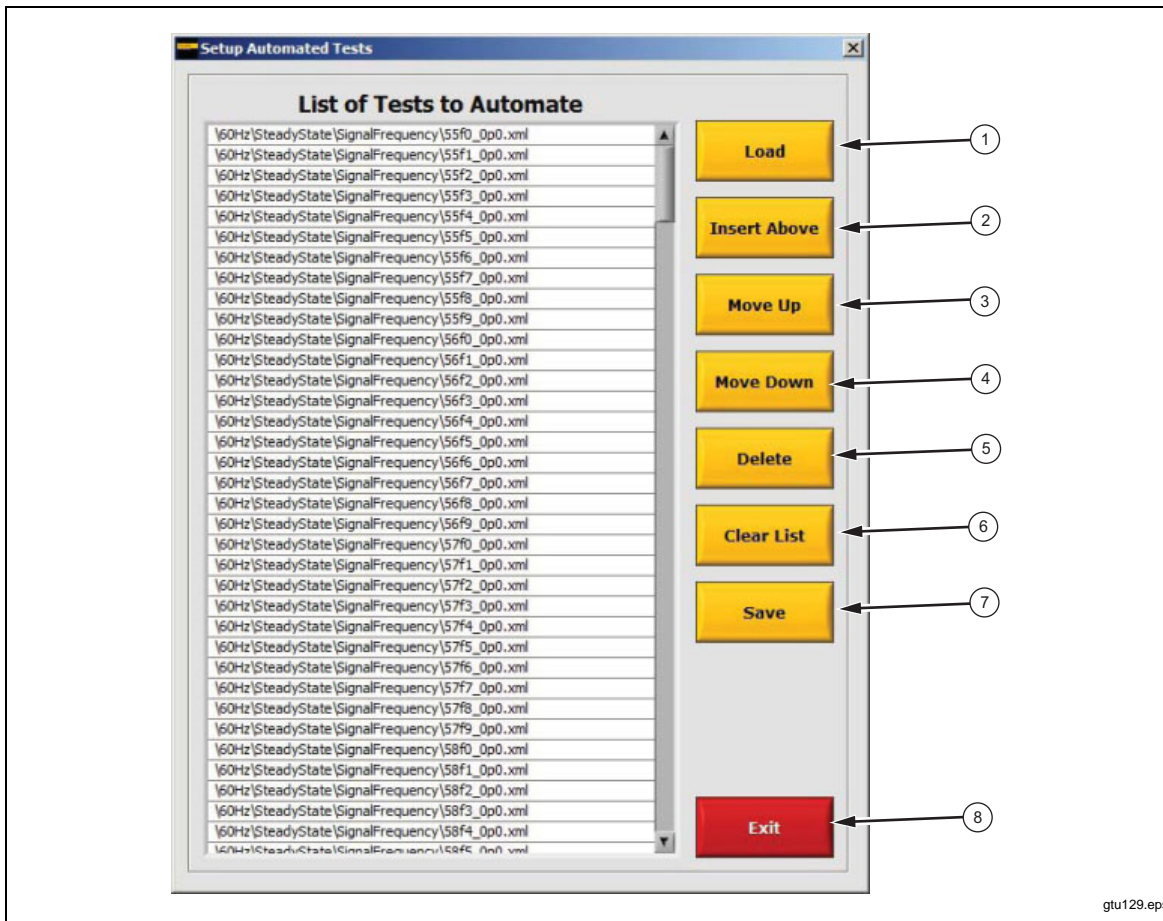

gtu129.eps

Item	Name	Description
①	Load	Load an automated test list.
②	Insert Above	Insert a single test into the list.
③	Move Up	Move the selected test up one position.

**Table 5-1. Setup Automated Test Window (cont.)**

Item	Name	Description
④	Move Down	Move the selected test down one position.
⑤	Delete	Delete the selected test.
⑥	Clear List	Clear the entire list.
⑦	Save	Save the list.
⑧	Exit	Exit the menu.

*Note*

*When you exit from editing an automated list, the list is saved in the file "LastAutomationList.xml". This happens even if you do not save the automated list.*



# Chapter 6

## General Testing

Title	Page
About this Chapter .....	6-3
General Testing .....	6-3
Test Configuration Instructions .....	6-6
General Test Parameters .....	6-6
Test Type Parameter .....	6-7
Test Parameters .....	6-7
Steady State Test Parameters .....	6-8
Frequency Ramp Test Parameters .....	6-9
Modulation Test Parameters .....	6-12
Step Test Parameters .....	6-14
Measurement Latency Test Parameters .....	6-15
Run a Single Test .....	6-16
Run a Custom Interactive Test .....	6-16





## About this Chapter

This chapter supplies instructions on how to do an interactive test on a UUT. To do the procedures in this chapter, the UUT must be connected and configured. If the UUT is not connected and configured, refer to “Prepare the UUT for Calibration” in Chapter 4.

For an alphabetical list of terms and abbreviations used in this chapter and manual, see “The Glossary” in Appendix A of this manual.

## General Testing

Custom interactive testing lets an operator make a single test, simulate or run it on a UUT, then interactively plot the results. The test parameters can be saved for to be used later.

When **Customize and Run Single Test** is clicked, the test configuration window shown in Table 6-1 opens. The test configuration window is the test creation and management interface used to make or change a single test. See Table 6-1.

When **Run Single Test** is clicked, a test of the operators choice is opened, run, and interactively graphed.

To run a custom interactive test refer to “Run a Custom Interactive Test” in this section. To configure the custom interactive test, refer to “Test Configuration Instructions”.

### *Note*

*Test parameters cannot be edited in general testing. To edit the parameters of a test, use custom testing.*

The test configuration window is the test creation and management interface to make or change a single test. Table 6-1 shows and describes the different areas of the test configuration window.

Table 6-1. The Test Configuration Window

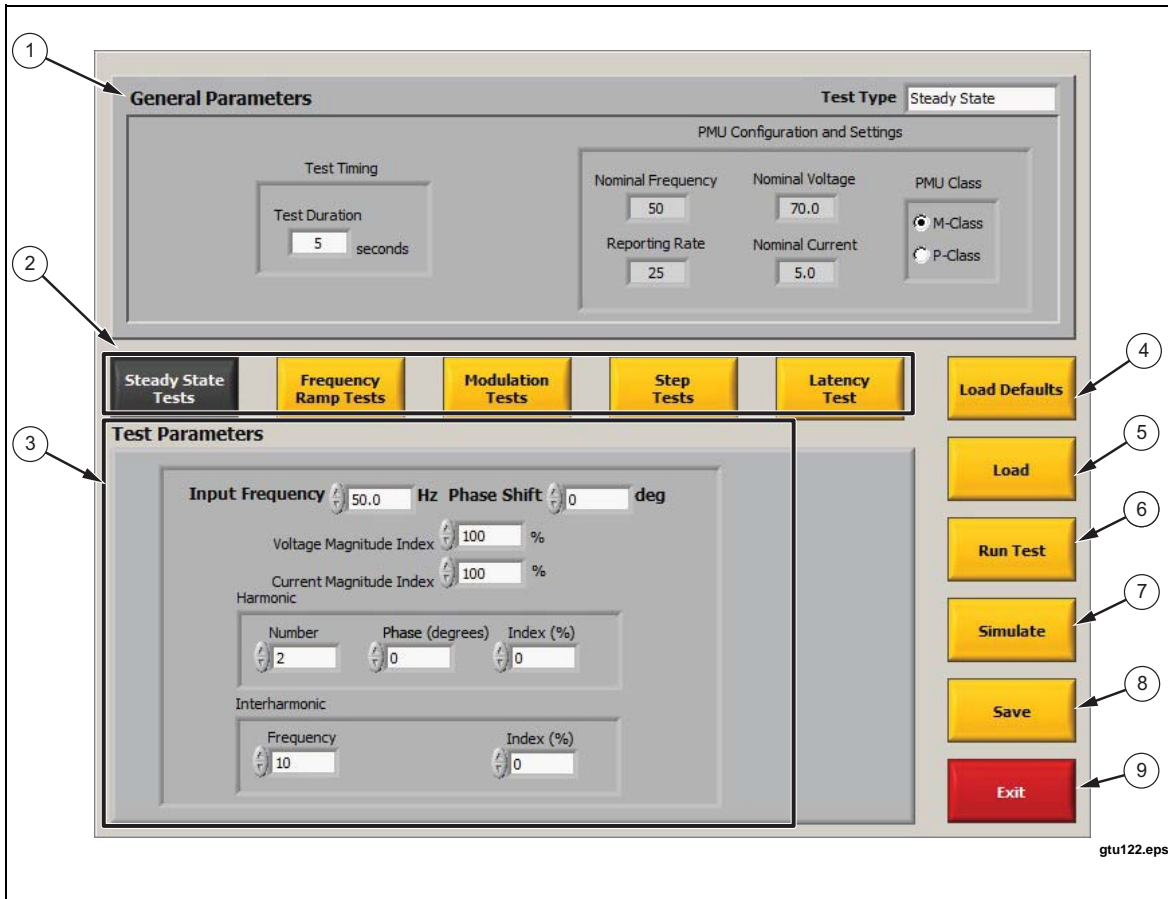

Item	Name	Description
①	General Test Parameters Area	Area that contains all the tests general test parameters (refer to “General Test Parameters” in this chapter).
②	Test Type Selection Buttons	Use to select the Test Type (refer to “Test Type Parameter” in this Chapter for more information).
③	Test Parameters Area	Area that contains the parameters of the test signal applied to the UUT for each test type (refer to “Test Parameters” in this chapter).
④	Load Defaults	Use to reset all parameters to the their default values.
⑤	Load	Use to open a file browser that lets you select and load a test from file.
⑥	Run Test	Use to run the selected test on the UUT.  <i>Note</i> <i>This button is not available and transparent when you are in Simulation Mode.</i>

**Table 6-1. The Test Configuration Window (cont.)**

Item	Name	Description
⑦	Simulate	Use to run the selected test on the Simulated PMU.
⑧	Save	Use to open a Save As dialog box that lets you save the current test. <i>Note</i> <i>Test parameters for all test types are saved, not just the parameters for the selected test type.</i>
⑨	Exit	Use to close the test configuration window.

## Test Configuration Instructions

Use this section to configure a custom interactive test. To configure a test, you must select a test type and set the general test parameters and also the UUT test parameters.

### General Test Parameters

General test parameters specify the type of test and test timing parameters for each test file. Table 6-2 shows and describes each general test parameter. Use the procedure in this section and the information in subsequent sections to configure the general test parameters.

To set the general test parameters (refer to Table 6-2):

1. Set the **Test Type** (refer to “Test Type Parameter” in this section).
2. Set the **Test Timing** parameters.

Table 6-2. General Test Parameters

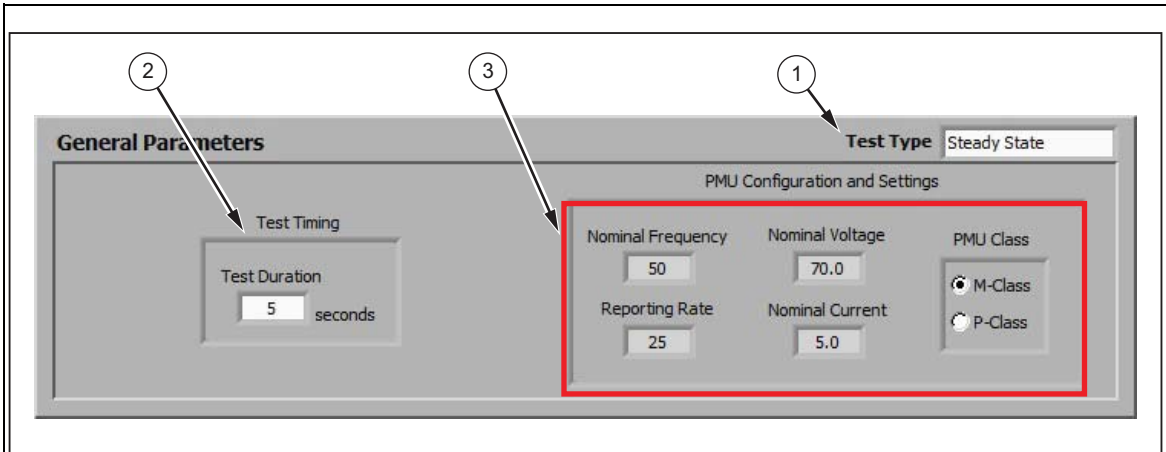

gtu123.eps

Item	Name	Description
①	Test Type	Use to see and select the test type. Each test file can have one test type selected. Refer to “Test Type Parameter” in this section for more information.
②	Test Timing Parameters	The test duration is the period that the test data is collected for analysis.
③	UUT Configuration Settings Indicators	Use to see the UUT personality and UUT configuration settings. The settings are for reference only cannot be changed from this window.

### Test Type Parameter

The test type parameter is type of test that the test file is configured for. Select a Steady State, Frequency Ramp, Modulation, or Step Test (see “Standard Compliance Tests and Subtests” in Chapter 4). The test type parameter tells the PMUCal Software which test parameters in the test file to use when a test is run or simulated.

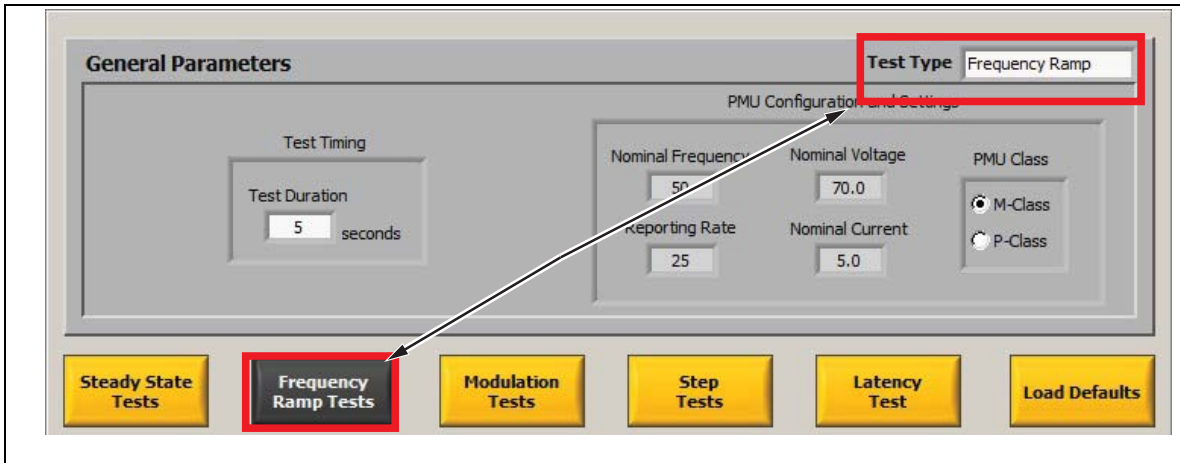

Figure 6-1. Test Type Selection

gtu124.eps

When the test configuration window is first opened, the test type defaults to Steady State. If a different test file is loaded, the test type changes to the test type saved in the test file. To change the test type, click on the test type selection drop-down box on the top of the window or click on the test type selection buttons (see Table 6-1 and Figure 6-1).

*Note*

*When a test is run, the calibration software only runs and reads the test parameters for the test shown in the test type combo box.*

### Test Parameters

The test parameters settings set the test parameters for each test type. Use the subsequent sections to set the test parameters for each test type.

### *Steady State Test Parameters*

A Steady State test is where the magnitude, and frequency are constant for the duration of the test (see “Standard Compliance Tests and Test Files” in Chapter 3 for more information). See Table 6-3 for a detailed description of each parameter on the Steady State test window.

To configure and run a Steady State test (refer to Table 6-3):

1. Set the **General Test Parameters**. (refer to “General Test Parameters” in this section).
2. Click **Steady State Tests**.
3. Set the **Steady State Test Parameters** as follows:
  - a. Set the **Input Frequency**.
  - b. Set the **Phase Shift**.
  - c. Set the **Voltage Magnitude Index**.
  - d. Set the **Current Magnitude Index**.
  - e. Set the **Harmonics Number, Phase, and Index**.
  - f. Set the **Interharmonic Frequency, Phase, and Index**.
4. Click **Save** to save the test (if desired).
5. Run the test. Refer to the instructions in “Run a Custom Interactive Test” in this chapter.

**Table 6-3. Steady State Test Configuration Window**

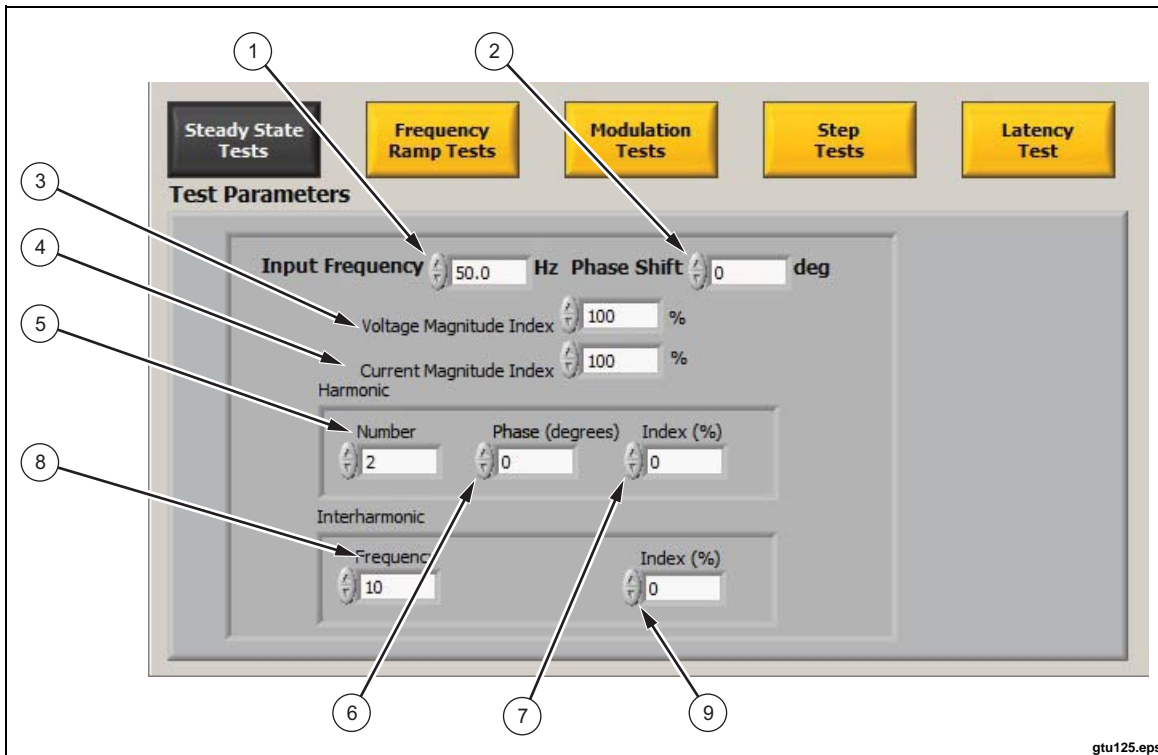

gtu125.eps

Item	Field Name	Range	Description
①	Input Frequency	(44.0 to 65.9) Hz	Set the test frequency.
②	Phase Shift	(-180° to 180°) degrees	Set the phase offset at the test start. All test signals are specified to be cosine waves.
③	Voltage Magnitude Index	(0 to 150) %	Set the percent of the nominal voltage that the 6135A System outputs.
④	Current Magnitude Index	(0 to 200) %	Set the percent of the nominal current that the 6135A System outputs.
⑤	Harmonic Number	0 to 100	Set a harmonic to the 6135A System voltage and current outputs.
⑥	Harmonic Phase	(-180° to 180°) degrees	Set the phase of the added harmonic relative to the fundamental phase.
⑦	Harmonic Index	(0 to 40) %	Set the magnitude of the added harmonic as a percentage of nominal magnitude.
⑧	Interharmonic Frequency	0 Hz to 9 kHz	Set a single interharmonic frequency to the 6135A System voltage and current outputs. Use this for the out-of-band interfering signals tests.
⑨	Interharmonic Index	(0 to 40) %	Set the magnitude of the interharmonic signal as a percentage of the nominal magnitude.

**Frequency Ramp Test Parameters**

A Frequency Ramp test is a dynamic test that tests how the UUT measures changes in frequency (see “Standard Compliance Tests and Test Files” in Chapter 3 for more information). See Table 6-4 for a detailed description of each Frequency Ramp test parameter.

To configure a Frequency Ramp test (refer to Table 6-4):

1. Set the **General Test Parameters**. (refer to “General Test Parameters” in this section).
2. Click **Frequency Ramp Test**.
3. Set the **Frequency Ramp Test Parameters** as follows:
  - a. Set the **Start Frequency**.
  - b. Set the **End Frequency**.
  - c. Set the **Ramp Rate**.
  - d. Set the **Phase Shift**.
  - e. Set the **Transition Time**.
4. Click **Save** to save the test (if desired).
5. Run the test. Refer to the instructions in “Run a Custom Interactive Test” in this Chapter.



**Table 6-4. Frequency Ramp Test Configuration Window**

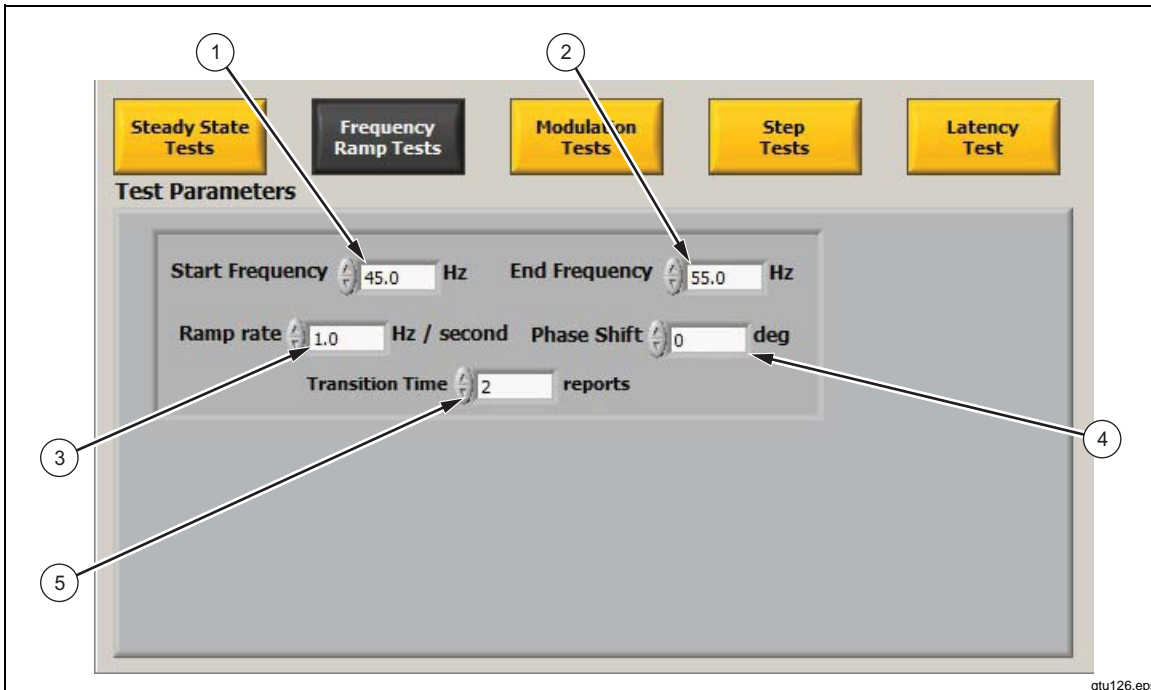

Item	Field Name	Range	Description
①	Start Frequency	(44.0 to 65.9) Hz	Set the test start frequency.
②	End Frequency	(44.0 to 65.9) Hz	Set the test end frequency.
③	Ramp Rate	(0.1 to 6.0) Hz	Set the frequency ramp rate in Hz/second.
④	Phase Shift	(-180° to 180°) degrees	Set the phase offset at the test start. All test signals are specified to be cosine waves.
⑤	Transition Time	(0 to 255) reports	Set the number of UUT reports to not include in the analysis or the reports at the start and end of the test duration.

### *Modulation Test Parameters*

A Modulation test is a dynamic test that tests UUT response to cosine modulated phase, amplitude, or both. (see “Standard Compliance Tests and Test Files” in Chapter 3 for more information). See Table 6-6 for a detailed description of each Modulation test parameter.

To configure a Modulation test (refer to Table 6-6):

1. Set the **General Test Parameters**. (refer to “General Test Parameters” in this section).
2. Click **Modulation Test**.
3. Set the **Modulation Test Parameters** as follows:
  - a. Set the **Input Frequency**.
  - b. Set the **Phase Shift**.
  - c. Set the **Phase Modulation Frequency**.
  - d. Set the **Phase Modulation Index**.
  - e. Set the **Amplitude Modulation Frequency**.
  - f. Set the **Amplitude Modulation Index**.
  - g. Set the **Settling Time**.
4. Click **Save** to save the test (if desired).
5. Run the test. Refer to the instructions in “Run a Custom Interactive Test” in this chapter.

**Table 6-5. Modulation Test Configuration Window**

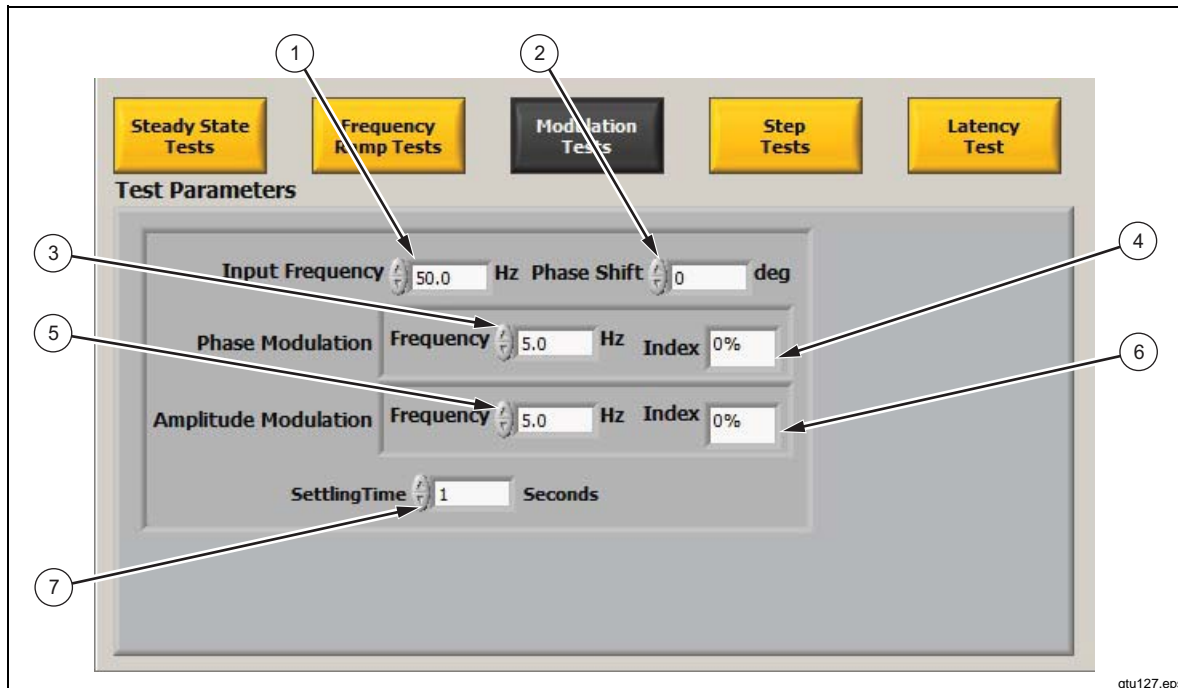

Item	Field Name	Range	Description
①	Input Frequency	(44.0 to 65.9) Hz	Set the frequency for the test.
②	Phase Shift	(-180° to 180°) degrees	Set the phase offset at the start of the test. All test signals are specified to be cosine waves.
③	Phase Modulation Frequency	(0.1 to 12) Hz	Set the frequency of the phase modulation.
④	Phase Modulation Index	(0, 1, and 10) %	Set the amplitude of phase shift.
⑤	Amplitude Modulation Frequency	(0.1 to 12) Hz	Set the frequency of the amplitude modulation.
⑥	Amplitude Modulation Index	(0 to 30) %	Set the amount of voltage or current amplitude in percentage to be applied to the frequency.
⑦	Settling Time	(0 to 255) reports	Set the number of UUT reports to not include in the analysis or the reports at the start and end of the test duration.  <i>Note</i> <i>The duration must be at least 1 second longer than the settling time.</i>

### Step Test Parameters

A Step Test is a dynamic test that tests the UUTs response to steps in magnitude or phase. (see “Standard Compliance Tests and Test Files” in Chapter 3 for more information). See Table 6-6 for a detailed description of each step test Parameter.

To configure a Step Test (refer to Table 6-6):

1. Set the **General Test Parameters**. (refer to “General Test Parameters” in this section).
2. Click **Step Test**.
3. Set the **Step Test Parameters** as follows:
  - a. Set the **Input Frequency**.
  - b. Set the **Phase Shift**.
  - c. Set the **Phase Step Size**.
  - d. Set the **Phase Amplitude Step Size**.
  - e. Set the **Step Time – Seconds Until Step**.
  - f. Set the **Step Time – Number of Steps**.
4. Click on **Save** to **Save the Test** (if desired).
5. Click **Save** to save the test (if desired).
6. Run the test. Refer to the instructions in “Run a Custom Interactive Test” in this chapter.

**Table 6-6. Step Test Configuration Window**

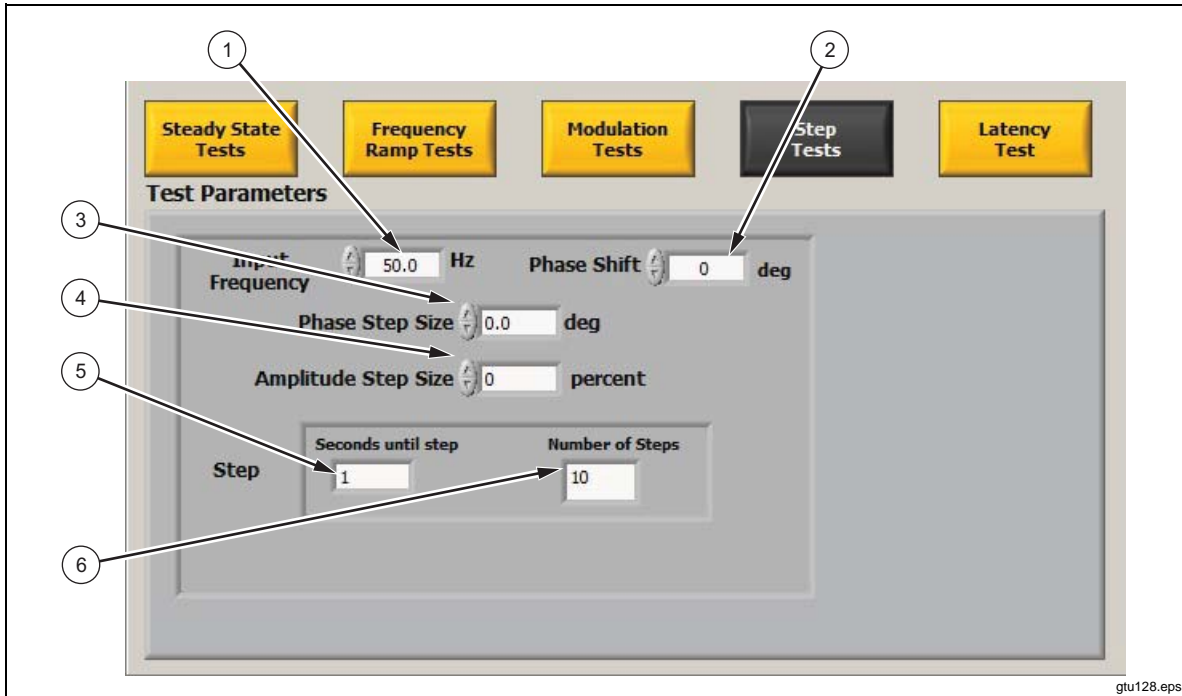

Item	Field Name	Range	Description
①	Input Frequency	(44.0 to 65.9) Hz	Set the frequency for the test.
②	Phase Shift	(-180° to 180°) degrees	Set the phase offset at the start of the test. All test signals are specified to be cosine waves.
③	Phase Step Size	(-180° to 180°) degrees	Set the amount of phase in degrees applied at the step.
④	Amplitude Step Size	(-100 to +200) %	Set the amount of voltage or current magnitude in percentage of nominal voltage applied at the step.
⑤	Seconds Until Step	(0 to 255) Seconds	Set the second that the step is accomplished.
⑥	Number of Steps	0 to 40	Set the how many step test iterations to run.

**Measurement Latency Test Parameters**

The Measurement Latency test does not have any parameters.

*Note*

*Interactive Latency test cannot be simulated and is not available when the Calibration System is in simulation mode.*

## **Run a Single Test**

1. Prepare the UUT for test and calibration (use the instructions in Chapter 4).
2. Click **Test** in the top **Navigation Menu**.
3. In **Interactive Testing**, click **Run Single Test**. A Windows Load dialog box opens.
4. Load a test file as follows:
  - a. Navigate to the test file in the test folder.
  - b. Select the test file.
  - c. Click **OK**.
5. After the test is complete, configure the plot configuration window (refer to “Make an Interactive Plot” in Chapter 7).

## **Run a Custom Interactive Test**

1. Click **Test** in the top **Navigation Menu**.
2. Click **Customize and Run Single Test**. A Windows Explorer dialog box opens.
3. Load a test file with similar test parameters (if desired):
  - a. Navigate to the test file in the test folder.
  - b. Select the test file.
  - c. Click **OK**.
4. Set the **General Test Parameters** (use the instructions in “General Test Parameters” in this chapter).
5. Set the **Test Parameters** (use the instructions in “Test Parameters” in this chapter).
6. Click **Save** to save the test (if desired).
7. Click **Run Test** to run the test on the UUT or click **Simulate** to run the test on the PMU simulator. The test starts and a progress window opens.
8. After the test is complete, configure the graph configuration window (refer to “Make an Interactive Graph” in Chapter 7).

# Chapter 7

## *Interactive Graphs, Results, and Reports*

Title	Page
Introduction.....	7-3
Interactive Graph .....	7-3
Graph Configuration Window .....	7-4
Make an Interactive Graph .....	7-4
Example Interactive Graph Configurations .....	7-7
One Source and One Input Graph Configuration Example.....	7-7
Two Sources and One Input Graph Configuration Example .....	7-7
Two Source and Two Inputs Graph Configuration Example.....	7-8
Y-Axis Analysis Results Configuration Example.....	7-9
Change the View of an Interactive Graph .....	7-10
Zoom-in and Zoom-out of a Plot .....	7-10
Undock and Dock a Panel .....	7-11
Change the Displayed Data .....	7-11
Change the look of the Plot.....	7-12
Test Results.....	7-13
Test Results Viewer.....	7-13
View Test Results in the Results Viewer .....	7-13
Log of Tests.....	7-14
Test Reports .....	7-15
Report Templates.....	7-15
Create One Report.....	7-16
Create Multiple Reports .....	7-16
View a Report.....	7-18





## Introduction

This chapter supplies the information necessary to make and read interactive graphs, test results, test reports, and certification reports.

For an alphabetical list of terms and abbreviations used in this chapter and manual, see “The Glossary” in Appendix A of this manual.

## Interactive Graph

The interactive graph (see Figure 7-1) is a test results viewer that has many view customizations to analyze test data. The view customizations lets the operator set custom the plot dimensions, zoom-in and zoom-out both vertically and horizontally, change the plot types, and adjust the colors and type of plot.

The interactive graph is one window that contains one or more panels. The test panels contain interactive plots of the test data. The test data results and how many panels are shown depends on the selections made on the plot configuration window. All of the view customizations are accessed when you right-click on a panel or field (refer to “Change the View of an Interactive Graph” in this chapter).

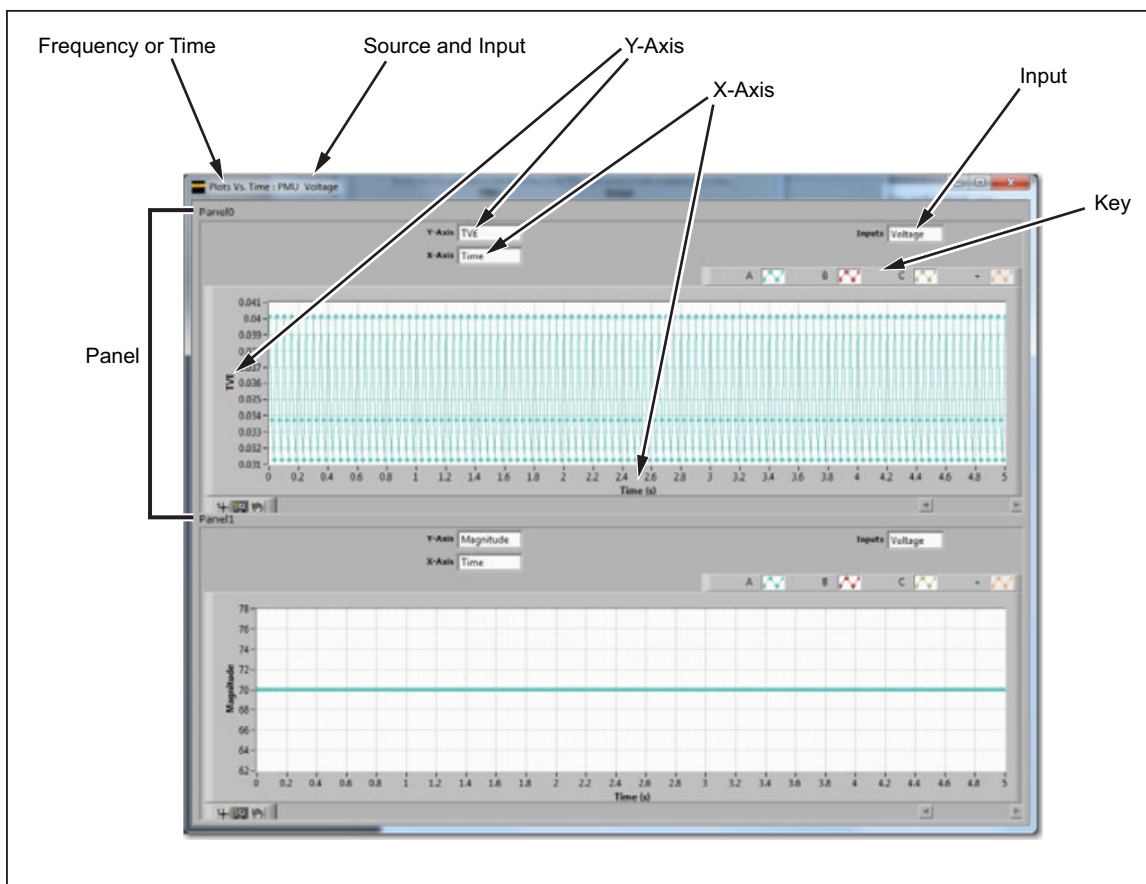

Figure 7-1. Interactive Graph Window and Panels

gtu103.eps

### Graph Configuration Window

To make and configure an interactive graph, use the graph configuration window (see Table 7-1). The graph configuration window automatically opens after the test data is collected and analyzed after a test is run.

To understand how to configure the panels and windows, use simulation mode and experiment with different configurations. The window titles on the interactive graph windows show what test information the panels in the window contain (see Figure 7-2). Refer to the example configurations in this section to visually see the relationship between the configuration selections and the interactive graph windows.

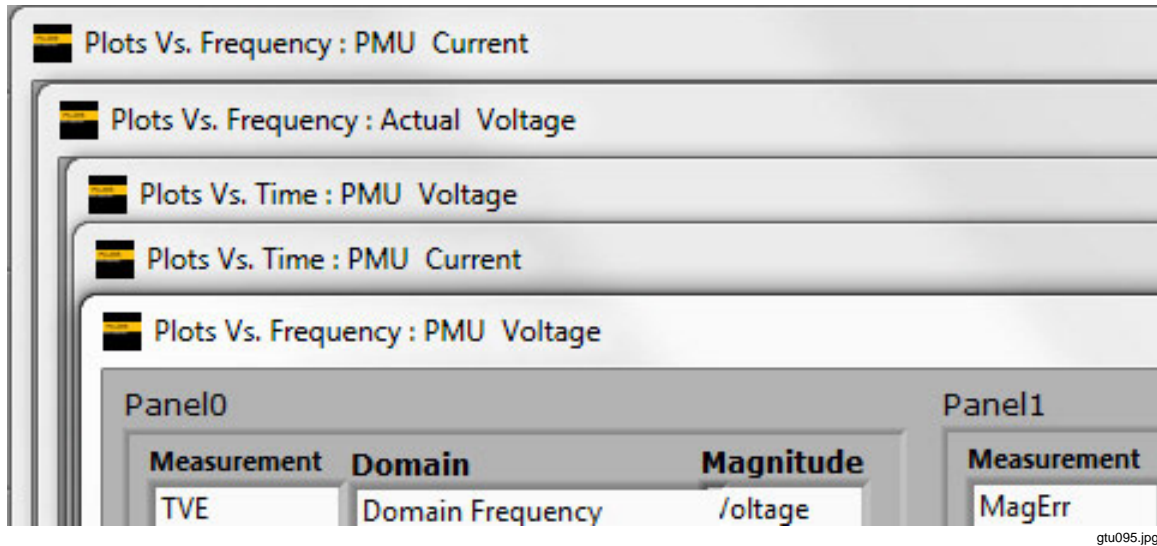

Figure 7-2. Interactive Graph Window Title Information

### Make an Interactive Graph

To make an interactive graph:

1. Run or simulate an interactive test (refer to “Run a Single Test” or “Run a Custom Interactive Test” in Chapter 6).
2. Configure the interactive graph with the interactive graph configuration window (refer to Table 7-1 and the examples in this section).
3. Customize the view as desired (refer to “Change the View of an Interactive Graph” in this chapter).

Table 7-1. Interactive Graph Configuration Window

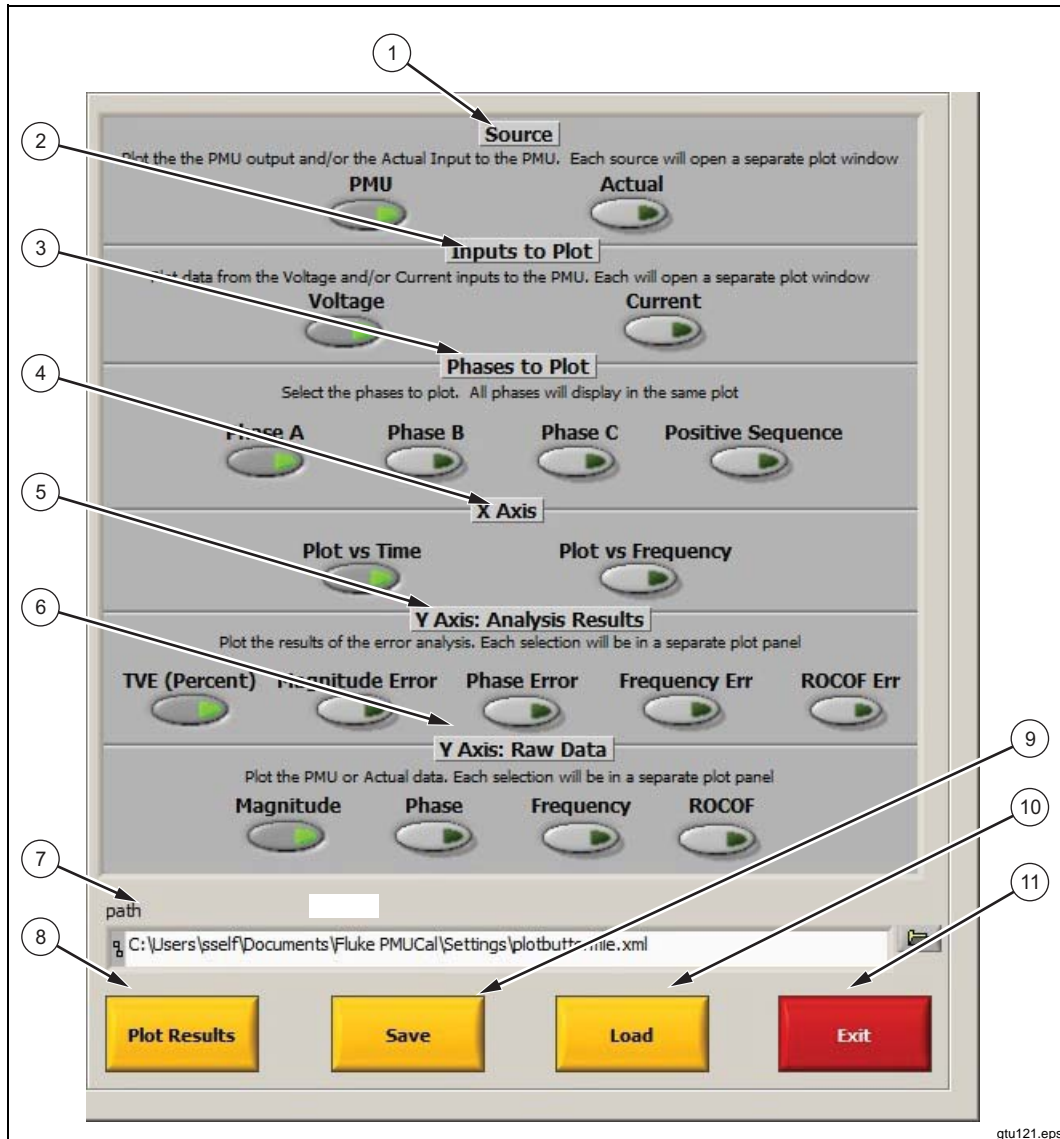

Item	Name	Description
①	Source	<p>Use to select the source data to plot. The two selections are:</p> <ul style="list-style-type: none"> <li>• <b>Reference (6135A Output)</b> – Plot the test data from the 6135A System.</li> <li>• <b>UUT Measured (PMU Output)</b> – Plot the test data from the UUT.</li> </ul> <p>If both are selected, each will open a new window.</p>

Table 7-1. Interactive Graph Configuration Window (cont.)

Item	Name	Description
②	Inputs to Plot	<p>Use to select the which input to plot. The two selections are:</p> <ul style="list-style-type: none"> <li>• <b>Voltage</b> – Plot the voltage test data from the source selected.</li> <li>• <b>Current</b> – Plot the current test data from the source selected.</li> </ul> <p>If Voltage and Current are both selected, each will open a new window for each source selected.</p> <p>Example: If both sources (actual and measured) are selected and both inputs (voltage and current) are selected, then four windows open: Actual Voltage, Actual Current, Measured Voltage, and Measured Current. Refer to the examples in the “Example Interactive Graph Configurations” section.</p>
③	Phases to Plot	<p>Use to select the phase to plot. The four selections are:</p> <ul style="list-style-type: none"> <li>• <b>Phase A, B, and C</b> – Plot the test data for the phase selected.</li> <li>• <b>Positive Sequence</b> – Plot the positive sequence for all three phases.</li> </ul>
④	X Axis	<p>Use to select the x-axis plot. The two selections are:</p> <ul style="list-style-type: none"> <li>• <b>Plot vs. Time</b> – Plot the test data against time.</li> <li>• <b>Plot vs. Frequency</b> – Plot the test data against frequency.</li> </ul> <p>If both are selected, each will open a new window for each source and input selected. One window will show Plot vs. Time and the other will show Plot vs. Frequency (Refer to Figure 7-2).</p>
⑤	Y Axis: Analysis Results	<p>Use to select the error value to plot. The five selections are:</p> <ul style="list-style-type: none"> <li>• <b>TVE (Percent)</b> – Plots the Total Vector Error in percentage</li> <li>• <b>Magnitude Error</b> – Plot the Magnitude Error component of the TVE.</li> <li>• <b>Phase Error</b> – Plot the Phase Error component of the TVE.</li> <li>• <b>Frequency Error</b> – Plot the difference (error) between the Actual Frequency output by the System and he measured frequency reported by the UUT.</li> <li>• <b>ROCOF Error</b> - Plot the difference between the actual Rate of Change of Frequency (ROCOF) output of the System and the measured ROCOF of the UUT.</li> </ul> <p>Each selection opens a new panel in the window.</p>
⑥	Y Axis: Raw Data	<p>Use to select the raw data to plot. The four selections are:</p> <ul style="list-style-type: none"> <li>• <b>Magnitude</b> – Plot the magnitude (amplitude) of the selected source..</li> <li>• <b>Phase</b> – Plot the phase of the selected source..</li> <li>• <b>Frequency</b> – Plot the frequency of the selected source.</li> <li>• <b>ROCOF</b> – Plot the Rate of Change of Frequency of the selected source.</li> </ul> <p>Each selection opens a new panel in the window.</p>
⑦	Path	<p>The location of the active plot settings file. Plot settings file contains the plot selections as well as plot colors, plot styles and other configurable plot options.</p>

**Table 7-1. Interactive Graph Configuration Window (cont.)**

Item	Name	Description
⑧	Plot Results	Uses the selections and makes the interactive graph(s). This button remains inactive (greyed out) until sufficient selections are made to create at least one interactive plot.
⑨	Save	Use to save the current selections as the default selections.
⑩	Load	Use to load the saved default selections.
⑪	Return	Use to close the window.

**Example Interactive Graph Configurations**

The examples in this section illustrate how the interactive graph will show the selections on the graph configuration window.

**One Source and One Input Graph Configuration Example**

Figure 7-3 is an example graph configuration with one source and one input selected. One window opens when configured as shown.

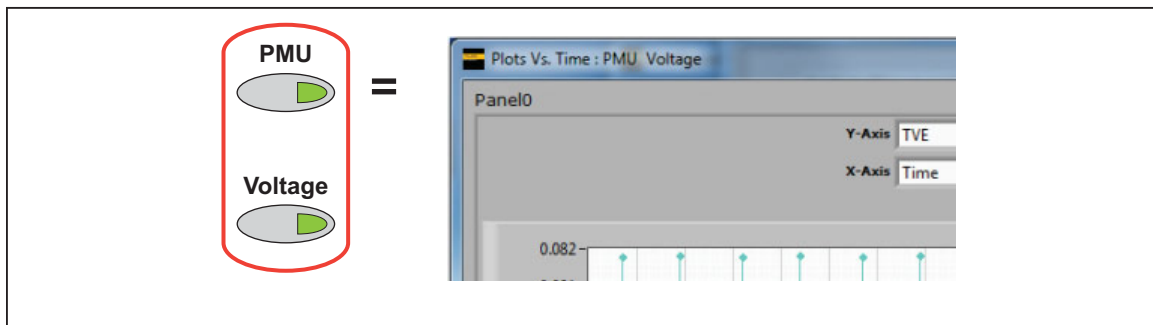
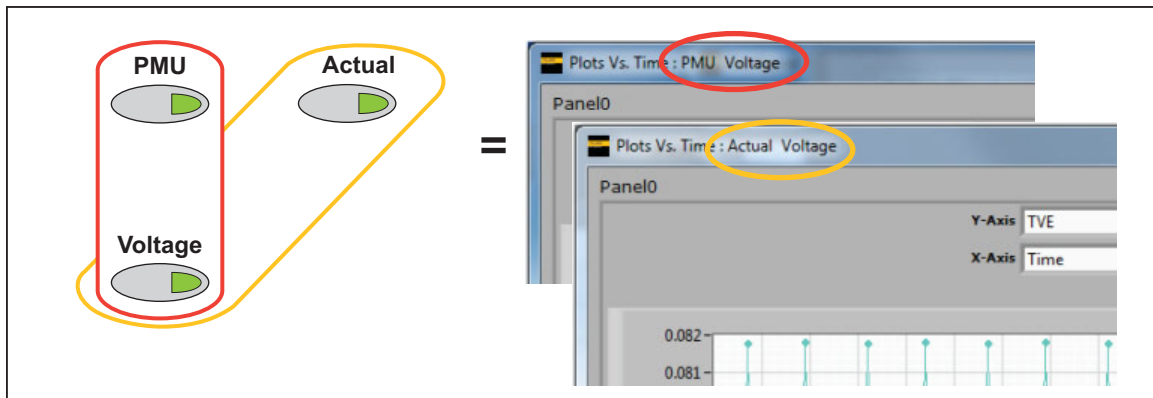

**Figure 7-3. Example Graph Configuration (One Source, One Input)**

gtu092.eps

**Two Sources and One Input Graph Configuration Example**

Figure 7-4 is an example graph configuration with two sources and one input selected. Two windows opens when configured as shown.



**Figure 7-4. Example Graph Configuration (Two Sources, One Input)**

gtu091.eps

*Two Source and Two Inputs Graph Configuration Example*

Figure 7-5 is an example graph configuration with two sources and two inputs selected. Four windows opens when configured as shown.

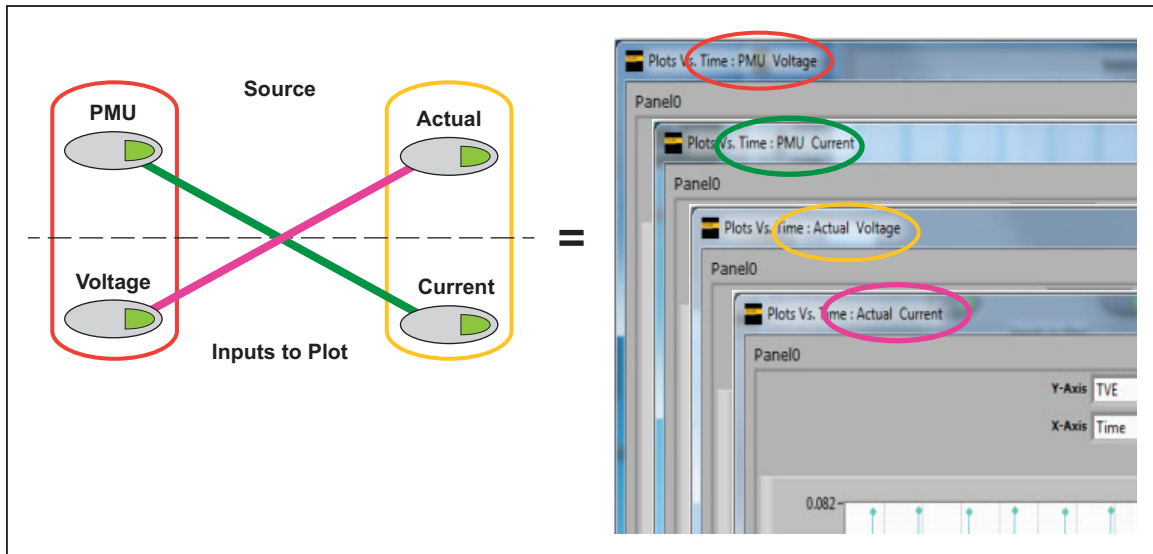

Figure 7-5. Example Graph Configuration (Two Sources, Two Inputs)

gtu093.eps

*Y-Axis Analysis Results Configuration Example*

Figure 7-6 is an example graph configuration with all the analysis selections selected. Each selection will open a separate panel in the window.

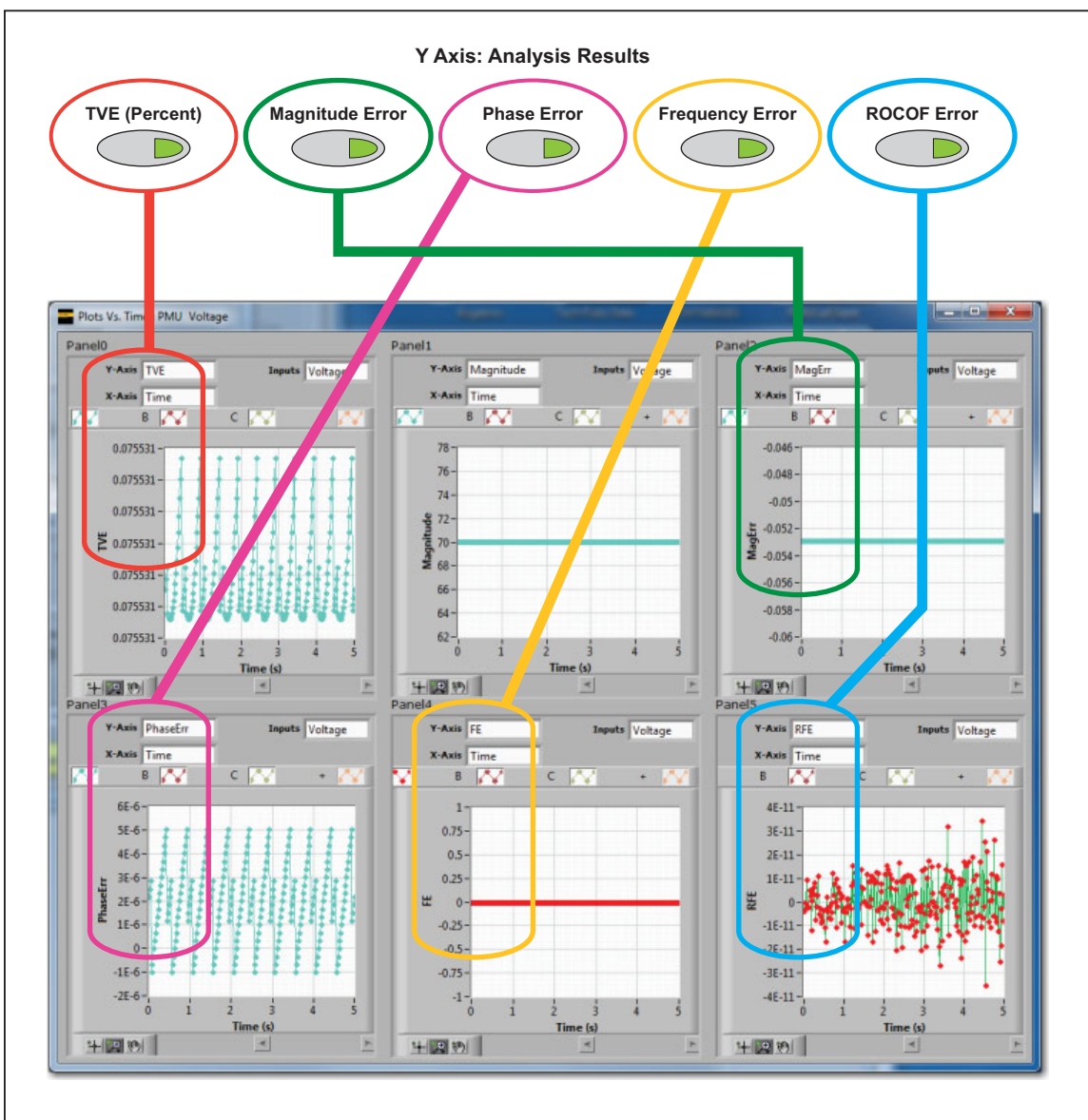

Figure 7-6. Example Interactive Graph Configuration

gtu094.eps

## Change the View of an Interactive Graph

### Zoom-in and Zoom-out of a Plot

To see the data closer, zoom-in and zoom-out of the plot. Zoom selection are: vertically, horizontally, and quadrant.

To zoom-in and zoom-out (refer to Figure 7-7 and 7-8):

1. Right-click on the plot or open the zoom tool menu and select Quadrant, Vertical, or Horizontal Zoom-in or Zoom-out.

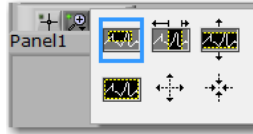

2. When the magnifier pointer shows:

For Vertical or Horizontal zoom, left-click to set the points of the plots that you want to zoom to and release the mouse button (see Figure 7-7).

For Quadrant, left-click and hold to make a square box over the area you want to zoom-in or zoom-out of (see Figure 7-8).

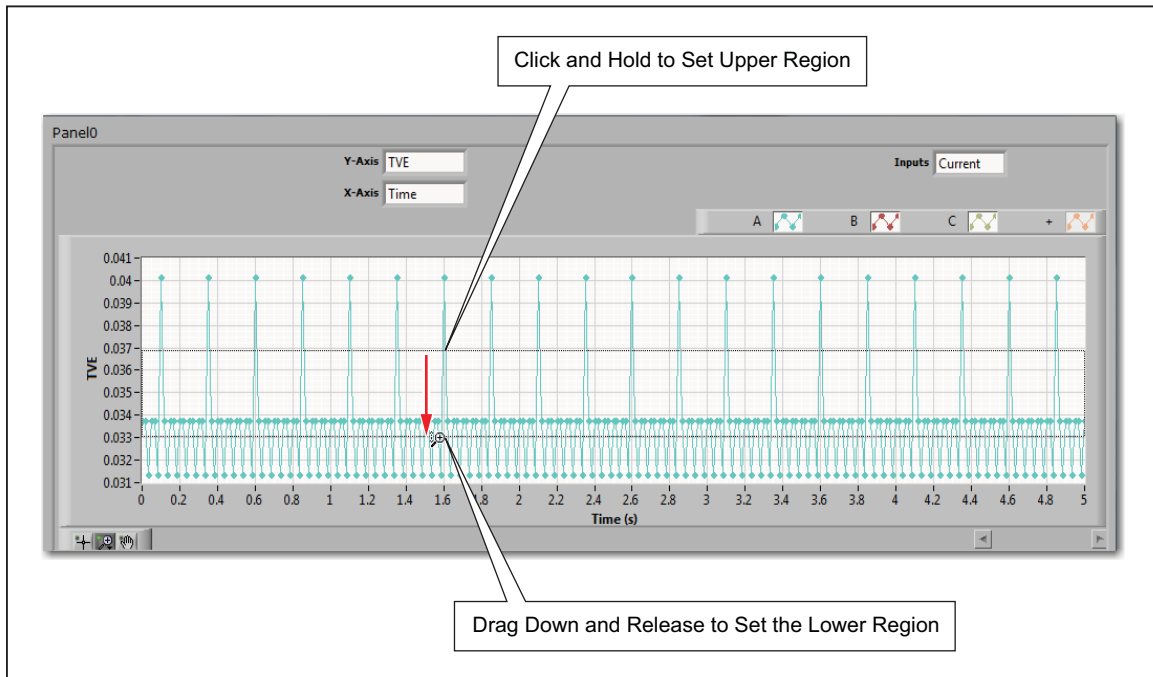

Figure 7-7. Example Vertical or Horizontal Zoom

gtu099.eps



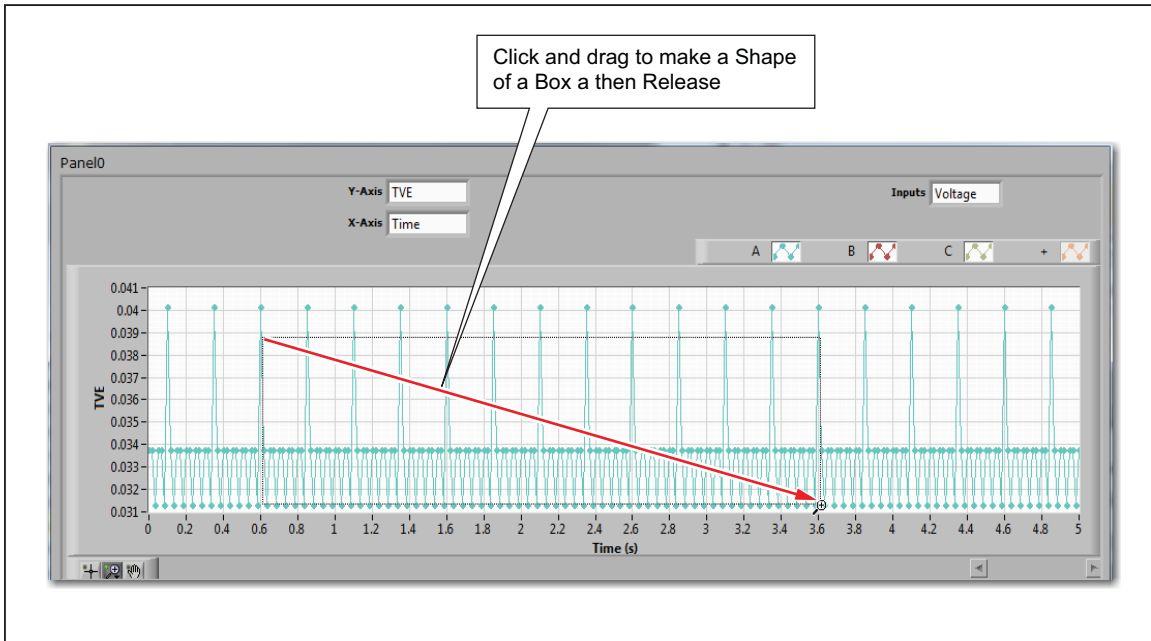

Figure 7-8. Example Quadrant Zoom

gtu100.eps

### Undock and Dock a Panel

The panels in the interactive graph window can be undocked (removed from) and docked (put back into) to let you resize the panel to get a closer view of the data.

To undock and dock a panel (refer to Figure 7-9):

1. Right-click on the grey area above the graph and select **Undock**.
2. Move and resize the panel as necessary.
3. To dock, right-click on the gray area and select **Dock**.

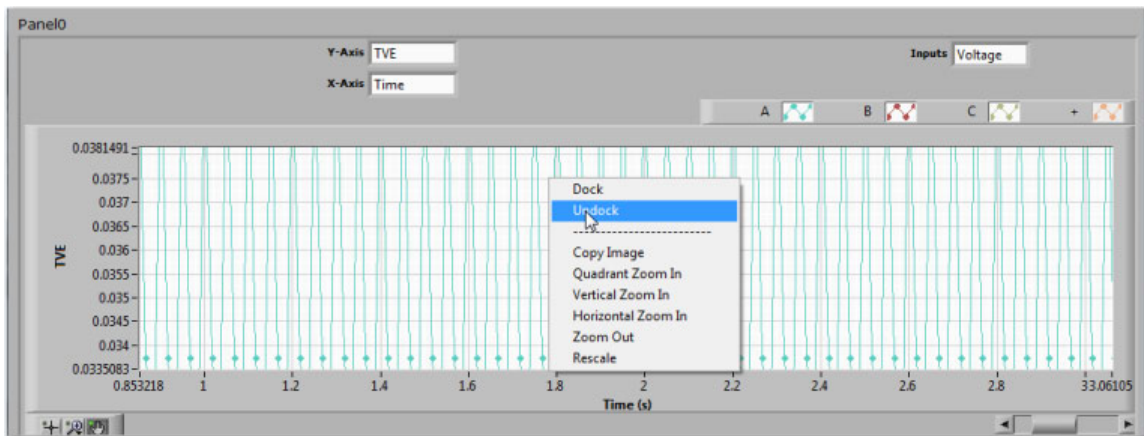

Figure 7-9. Undock and Dock a Panel

gtu097.jpg

### Change the Displayed Data

The data shown in the panel can be changed as necessary to see different data.

To change the data shown in the panel (refer to Figure 7-10), left-click in on the combo box under **Measurement**, **Domain**, or **Magnitude** and select the new data to be shown.

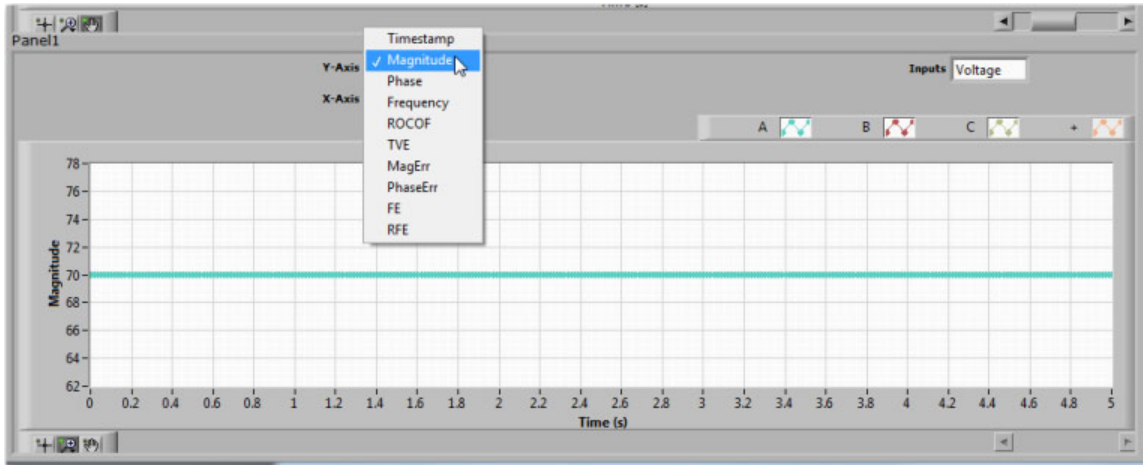

gtu098.jpg

Figure 7-10. Change the Data Displayed in the Panel

*Change the look of the Plot*

The plot lines can be changed to help you see the plot lines better.

To change the plot lines, right-click on the data key and select the appropriate menu item to change the look of the plot.

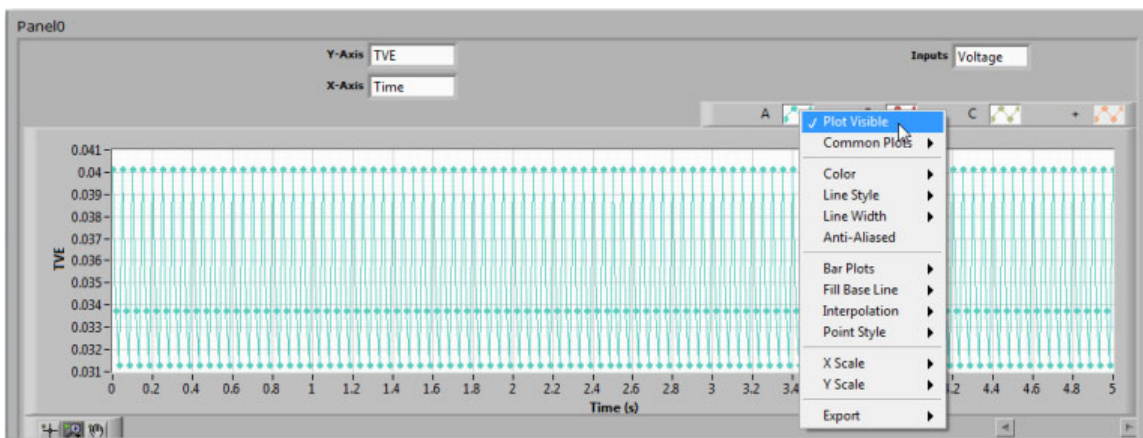

gtu101.jpg

Figure 7-11. Example Change the Look of a Plot

## Test Results

### Test Results Viewer

The test results viewer (Show Results button) is a spreadsheet view of the test results that shows maximum test results for each compliance test and subtest. The results viewer shows the test results in the active results file that is shown in the result file path in the top navigation menu. Test results are saved to the active test results file as tests are completed.

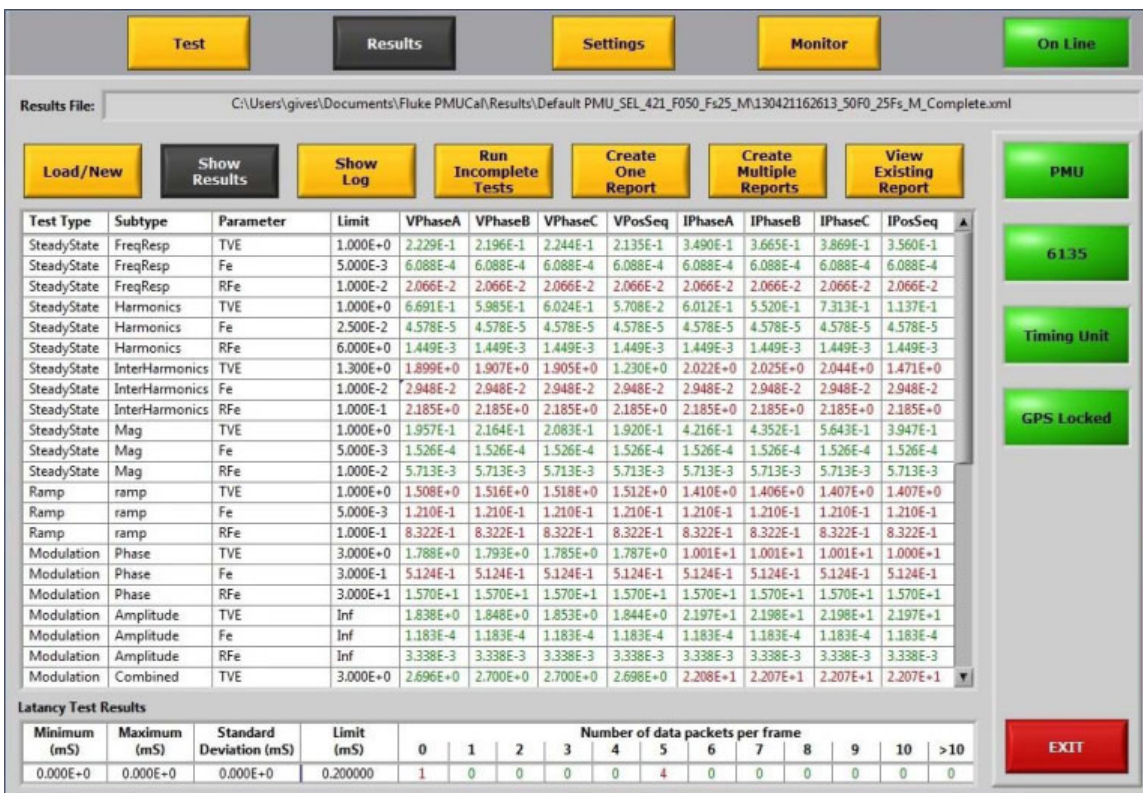

Figure 7-12. The Test Results Viewer

gtu086.jpg

### View Test Results in the Results Viewer

To view test results, click **Results** on the top navigation menu then select **Show Results**. At least one test must be run to see data in the spreadsheet. The results file saves test results for interactive and automated tests (refer to “Test Results and Results Files” in Chapter 3). The data in the spreadsheet is in scientific notation. The number after the “E” is the exponent (Example: 2.34E-11 is 2.34<sup>-11</sup>).

When you click Results on the top navigation menu, the test results data is automatically imported from the active test results file shown in the result file. The limits for each test in *IEEE C37.118.1-2011* are shown in the limits column of the spreadsheet. When the test results data is imported, the data is compared to the data in the limit column. If the data is above the acceptable limits, the data is shown in red. Red indicates that the test did not pass. Parameters inside the limits that passed are shown in green.

### Log of Tests

The Show Log button on the results viewer screen shows a complete list of tests run and their completion status. From the Show Log screen (see Figure 7-13), tests can be directly modified then tested again. When complete, the test results can be interactively plotted (refer to “Incomplete Tests” in Chapter 5).

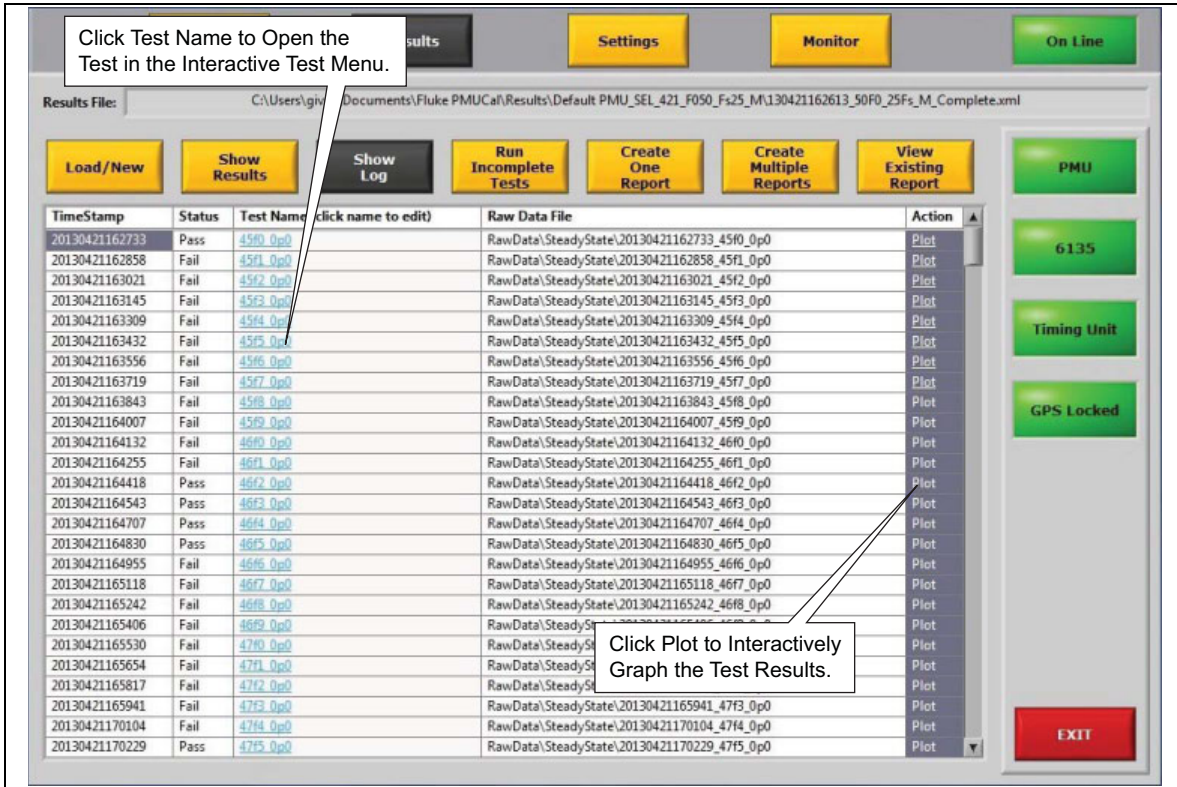

Figure 7-13. Test Log Example

gtu117.eps

## Test Reports

From the results screen, a formal calibration report can be generated. To make a calibration report, click **Results** on the top navigation menu then select **Create One Report** or **Create Multiple Reports**. One report makes a single report with all test results. Multiple reports makes separate reports for each result file in a list. Individual reports can be viewed by selecting View Existing Report.

### *Note*

*Microsoft Excel must be installed on the Client PC to be able to create or view reports.*

## Report Templates

Report generation uses report templates in a Microsoft Excel spreadsheet format. The template files can be found in the .\Reports\Templates folder. There is no limit to the number of different template files. The templates can be configured in any way to suit requirements. There must be a worksheet called: **DataIn**

This worksheet is used by Calibration System to insert the raw data. An example template is supplied with the Test Files called: **Example\_Report\_Template**

### *Note*

*DO NOT use this template as your working template because it may be overwritten if the Test Files are reinstalled at a later date. You can make a copy of this file and use a different name. The contents should be changed to reflect individual requirement. The report files are saved using the same file extension as the template used.*

Tip: Column C, (Label), of the raw data passed to the template is an identifier that is unique to that line of results. This allows the use of the Microsoft Excel VLOOKUP() command to be used on other worksheets to search for lines of data.



### Create One Report

To create a single report of all test results:

1. Click on **Create One Report**. A prompt will appear asking which report template to use. See Figure 7-14.
2. Select the report template required and click on **OK**. A report is now created using Microsoft Excel and on completion the location is reported in a dialog box.

#### Note

*The time it takes to create a report is dependent on the complexity of the report template. Allow time for it to complete.*

3. Selecting **YES** to view a report will open Microsoft Excel displaying the report.

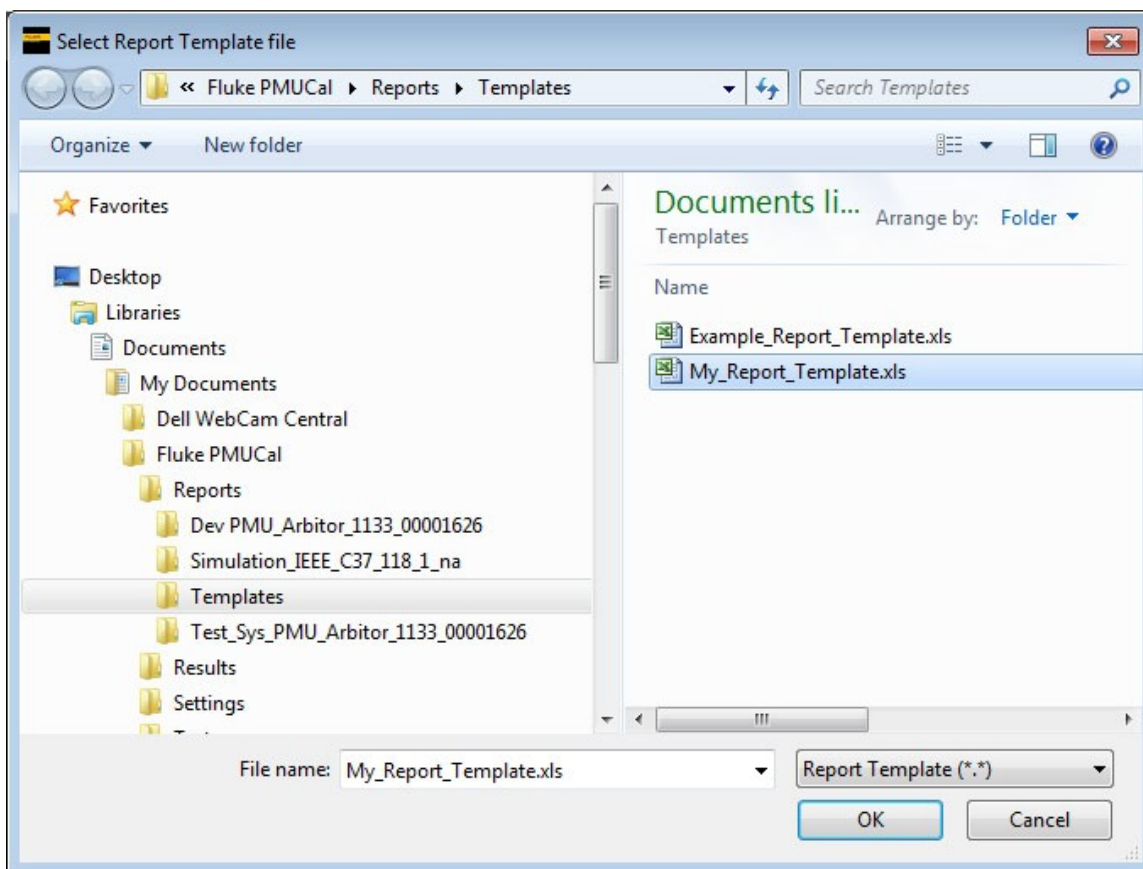

Figure 7-14. Template Selection

gtu153.jpg

### Create Multiple Reports

To create separate reports for each result file from a list:

1. Click on **Create Multiple Reports**. A screen will appear which allows the creation of a list of result files that will have reports created. See Figure 7-15.
2. Create a list of result files and click on **Create Reports**. A prompt will appear asking which report template to use. See Figure 7-14.

#### Note

*Multiple reports use the same report template for all reports.*

3. Select the report template required and click on **OK**. The individual reports are now

created using Microsoft Excel and on completion, their location is reported in a dialog box. Individual reports can be viewed clicking on the **View Existing Report**.

*Note*

*The time it takes to create a report is dependent on the complexity of the report template. Allow time for it to complete.*



Figure 7-15. List of Results

gtu156.jpg

### View a Report

Individual reports can be viewed by clicking on **View Existing Report**. A screen will appear that will allow navigation to a report. See Figure 7-16.

Select the required report and click on OK. Microsoft Excel will open displaying the report.

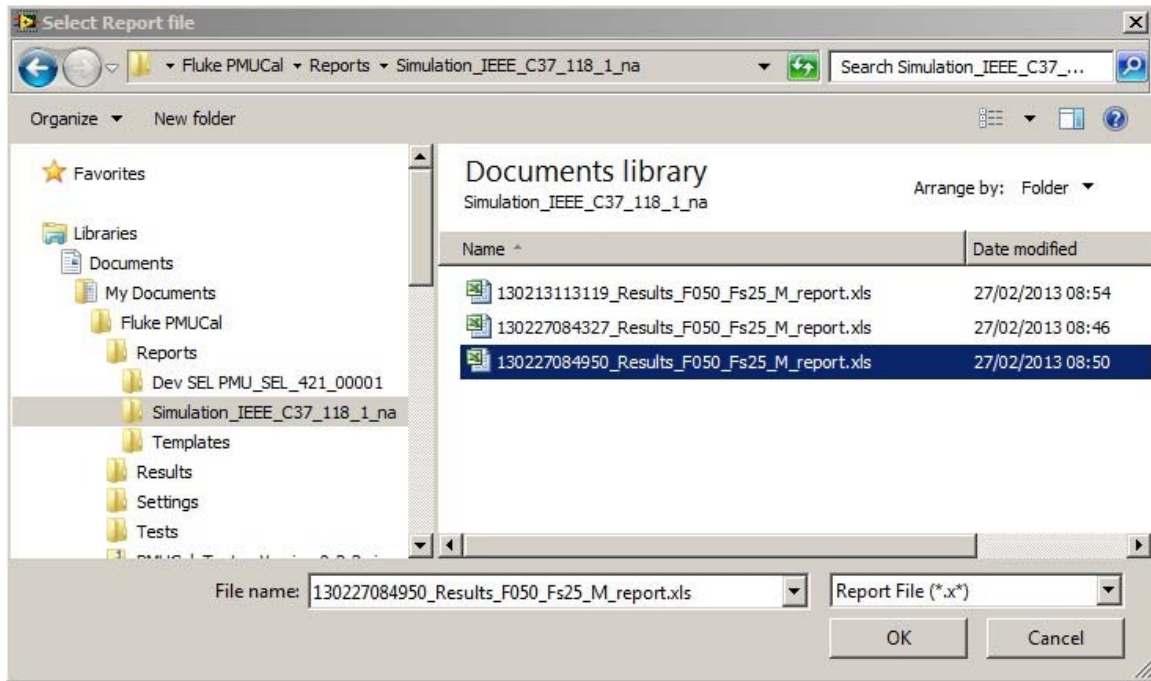

Figure 7-16. Report Selection

gtu155.jpg



## Test Report

UUT Identifier: **Simulation**  
 UUT:Serial Number: **na**  
 UUT Manufacturer: **IEEE**  
 UUT Model: **C37\_118\_1**  
 UUT Class: **M**  
 Nominal Frequency: **60Hz**  
 Reporting Rate: **60 Reports per second**

### Report Summary

Total number of measurements: 308  
 Number of Passed measurements: 296  
 Number of measurements outside test specification: 0  
 Number of incomplete measurements: 24

### Measurement status indicators:

F Measurement outside test specification  
 I Measurement incomplete

### Measurement Results

#### Test: Steady State - Frequency Response

(C37.118.1 Section 5.5.5) Signal Frequency Range tests apply a series of steady state input signals at 0.1Hz increments across the range specified in table 3 depending on the PMU reporting rate.

	Voltage Phase A	Voltage PhaseB	Voltage Phase C	Voltage Pos Seq	Current Phase A	Current Phase B	Current Phase C	Current Pos Seq	Limit
TVE	0.2238	0.2232	0.2211	0.1841	0.2238	0.2232	0.2211	0.1841	1
Fe	1.53E-06	1.53E-06	1.53E-06	1.53E-06	1.53E-06	1.53E-06	1.53E-06	1.53E-06	0.005
RFe	1.69E-09	1.69E-09	1.69E-09	1.69E-09	1.69E-09	1.69E-09	1.69E-09	1.69E-09	0.01

gtu120.eps

**Figure 7-17. Example Report**



# **Chapter 8**

## ***Troubleshooting, Maintenance, and Care***

<b>Title</b>	<b>Page</b>
About this Chapter .....	8-3
Troubleshooting .....	8-4
General .....	8-4
6135A/PMU System Timing Unit .....	8-4
Server PC .....	8-5
6135A Three Phase Power Standard .....	8-5
GPS Receiver .....	8-6
Network .....	8-6
Calibration Software .....	8-7
UUT .....	8-7
Test Reports .....	8-9
Cleaning .....	8-10
Performance Verification and Repair Information .....	8-10



## About this Chapter

This chapter provides information to troubleshoot the Calibration System.

For an alphabetical list of terms and abbreviations used in this chapter and manual, see “The Glossary” in Appendix A of this manual. For system connection information, see Figure 8-1.

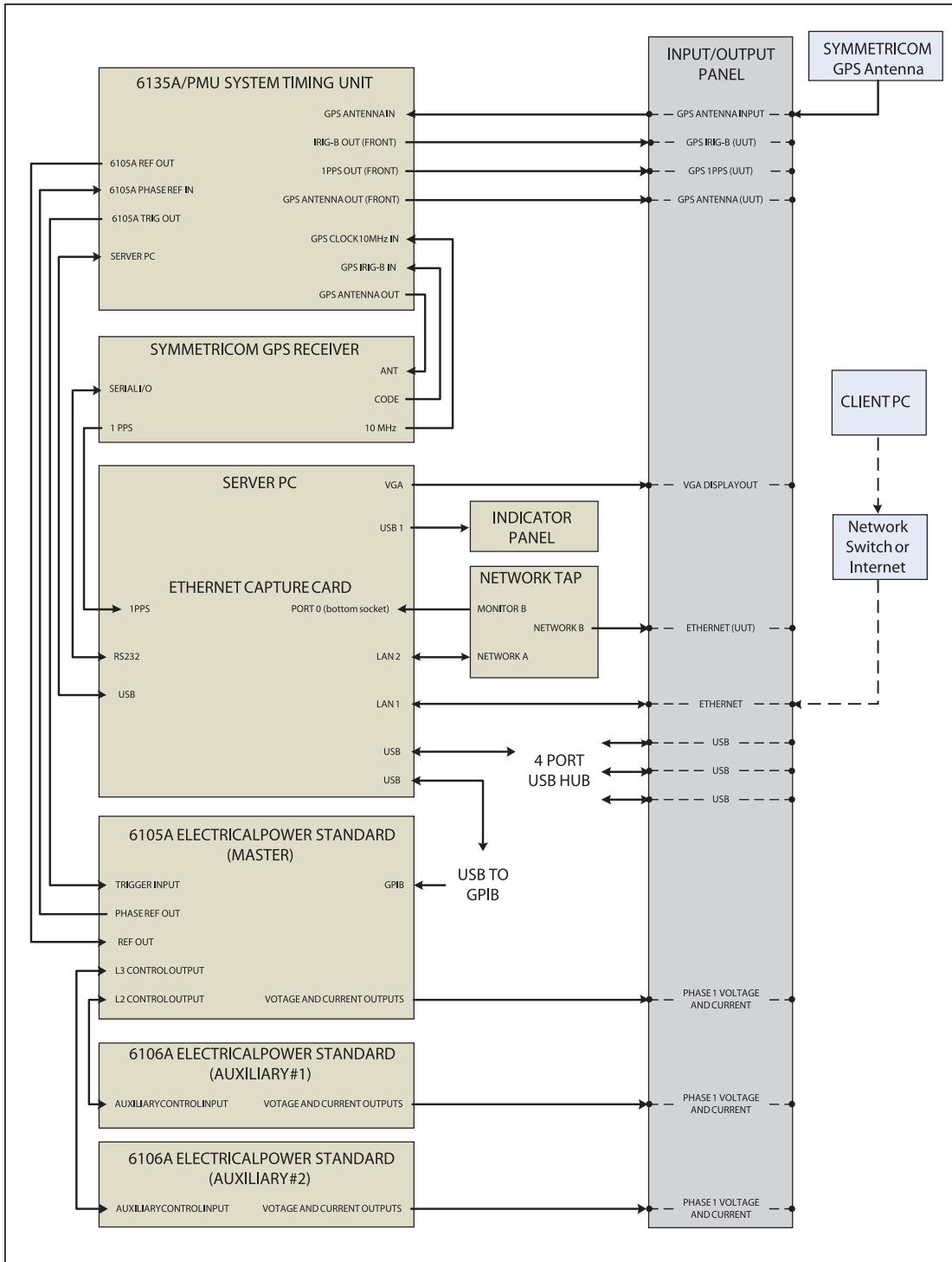

Figure 8-1. System Connections

gtu008.eps

## Troubleshooting

### General

Problem	Probable Cause	Action
A unit in the Calibration System does not turn on.	<ol style="list-style-type: none"> <li>1. Not plugged in.</li> <li>2. Power not available.</li> <li>3. Fuse blown.</li> <li>4. Power module or power circuit board is bad.</li> </ol>	<p>Complete these steps in order:</p> <ol style="list-style-type: none"> <li>1. Make sure the unit is plugged in and power is available.</li> <li>2. Unplug the unit and check the fuses.</li> </ol>

### 6135A/PMU System Timing Unit

For information on the LEDs on the front panel, see “6135A/PMU System Timing Unit” in Chapter 1.

Problem	Probable Cause	Action
IRIG Present LED is off when power is on.	When the LED is off, the system is not receiving a IRIG signal or connected to the IRIG output on the GPS receiver.	<p>Complete these steps in order:</p> <ol style="list-style-type: none"> <li>1. Make sure the GPS receiver is locked onto a satellite. See “GPS Receiver” in Chapter 3.</li> <li>2. Check the IRIG connection, see Figure 8-1.</li> <li>3. On the GPS Receiver menu, make sure that the “F90 Code Output Config” is set to “IRIG-B000 1344”.</li> </ol>
GPS Clock Available LED if off when power is on.	When the LED is off, the system is not receiving a IRIG signal or connected to the IRIG output on the GPS receiver.	<p>Complete these steps in order:</p> <ol style="list-style-type: none"> <li>1. Check the GPS Clock 10 MHz In connection. See Figure 8-1.</li> <li>2. On the GPS Receiver menu, make sure that the “F11 J2 Output Config” is set to “Rate 10MPPS”.</li> </ol>
REFP Active is off when power is on.	When the LED is off, the system is not receiving a REFP signal or connected to the REFP output on the GPS receiver.	Check the 6135A/PMU System Timing Unit Ref Out to the 6105A Phase Ref Out connection. See Figure 8-1.

**6135A/PMU System Timing Unit (cont.)**

Problem	Probable Cause	Action
Host Activity LED is flashing steadily and “No PMU-Cal Device” error message appears during a test.	USB Connection between the Server PC and the 6135A/PMU System Timing Unit has a problem.	Complete these steps in order: 1. Check the USB connection between the Server PC and the 6135A/PMU System Timing Unit. See Figure 8-1. 2. Reset all the units in the Calibration System.
One PPS LED is not flashing one time per second when connected to GPS receiver.	When the LED is off, the system is not reading the UTC time from the GPS Receiver.	Complete these steps in order: 1. Make sure the GPS receiver is locked onto a satellite. See “GPS Receiver in Chapter 3. 3. Check the IRIG connection. See Figure 8-1. 2. On the GPS Receiver menu, make sure that the “F90 Code Output Config” is set to “IRIG-B000 1344”.
Status LED does not flash when the power is on (on or off all the time when power is on).	If the Timing Unit is functional, the light will flash in a simulated “heartbeat” pattern. If the light is continually on or off, this could be an indication that the system has malfunctioned.	Reset power to the unit. If this does not fix the issue, contact Fluke Calibration.
AUX Indicator LED flashes.	Lost connection to Server PC.	Reset the Server PC.

**Server PC**

For information on the LEDs on the front panel, see “6135A/PMU System Timing Unit” in Chapter 1.

Problem	Probable Cause	Action
POWER LED is off when power is on.	When the LED is off, the PC is not on indicating that there is an internal problem.	See the Server PC Users Manual. Contact Fluke Calibration if the problem cannot be determined (see Contact Fluke Calibration in Chapter 1).
HDD LED is not flashing when power is on.	When the LED is not flashing, data is not being transferred.	

**6135A Three Phase Power Standard**

For troubleshooting information on the 6135A, see “6100B/6105A Three Phase Power Standard Operators Manual”.

### GPS Receiver

For information on the GPS Receiver and the LEDs on the front panel, see “Symmetricom GPS Receiver” in Chapter 1.

Problem	Probable Cause	Action
GPS Receiver reports not locked onto a satellite.	<ol style="list-style-type: none"> <li>1. Antenna does not have a clear signal from a minimum of four satellites.</li> <li>2. Antenna could be damaged or dirty.</li> </ol>	<p>Complete these steps in order:</p> <ol style="list-style-type: none"> <li>1. Make sure the 6135A/PMU System Timing Unit is on.</li> <li>2. Check the antenna.</li> <li>3. On the rear panel of the 6135A/PMU System Timing Unit, disconnect the “GPS Antenna In” and connect it directly to the “Antenna In”. Wait for the GPS Receiver to lock on to four satellites. See Figure 8-1.               <ol style="list-style-type: none"> <li>a. If the GPS Receiver successfully locks on to four satellites, then reconnect the antenna to the “GPS Antenna In” on the rear panel of the 6135A/PMU System Timing Unit (see Figure 8-1). Reset the entire system and wait to see if the GPS Receiver locks on to satellites in the normal configuration. If 20 minutes passes and the GPS Receiver has not locked on to four satellites, contact Fluke Calibration.</li> <li>b. If the GPS Receiver does not lock on to four satellites with the antenna directly connected, check the antenna position. See the Symmetricom, GPS Receiver and Antenna Installation Manual for troubleshooting procedures.</li> </ol> </li> </ol>
Calibration System software reports that the GPS Receiver is not locked but the receiver front panel says it is locked.	RS232 link from Server PC to GPS receiver not working.	Open the rear door of the Calibration System cabinet and check that the RS232 cable between the GPS Receiver Serial I/O port and the Server PC serial I/O ports are connected.

### Network

Problem	Probable Cause	Action
Attempted to connect to the Server PC with an IP address or PC Server name and “Could not find a Server” error message appears.	<ol style="list-style-type: none"> <li>1. Server PC is not on.</li> <li>2. The network cable is connected to the UUT port.</li> <li>3. Wrong IP address or Server PC name.</li> </ol>	<p>Complete these steps in order:</p> <ol style="list-style-type: none"> <li>1. Make sure the Server PC is on.</li> <li>2. Ping the Server PC. For PC to PC connections, the default IP address is 192.168.0.250 or “PMUCAL”. For networks with dynamic IP addresses, check with the Network administrator to get the IP address.               <ol style="list-style-type: none"> <li>a. If the ping is successful, the Client PC has the correct IP assigned and are connected to the correct Server PC Ethernet port.</li> <li>b. If the ping is not successful, make sure the Ethernet connection is configured as described in “Network Connection Instructions” in Chapter 2.</li> </ol> </li> <li>3. If a connection cannot be made, contact Fluke Calibration.</li> </ol>

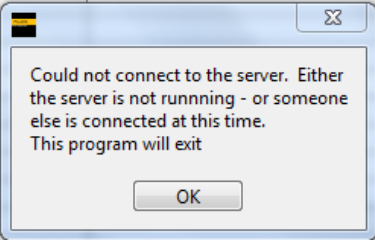

**Calibration Software**

Problem	Probable Cause	Action
Cannot make default test files or install software.	No admin rights on the PC.	Have a Network Administrator turn on administrative rights.
This error message appears: 	<ol style="list-style-type: none"> <li>1. Another Client PC is connected to the Server PC.</li> <li>2. The Calibration Software was previously closed incorrectly.</li> <li>3. The last time the Client PC to Server PC connection was terminated, the software on the Server PC did not close correctly.</li> </ol>	Click OK on the message dialog box to close the Calibration Software. Reopen the Calibration Software and try to connect again. If the error message appears again, reset the Server PC.

**UUT**

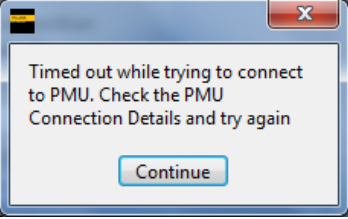
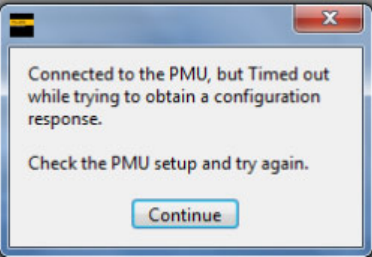
Problem	Probable Cause	Action
This error message appears: 	<ol style="list-style-type: none"> <li>1. The Server PC is not connected to the UUT.</li> <li>2. Incorrect UUT IP address or port.</li> <li>3. Problem with the UUT configuration.</li> <li>4. UUT does not use C37.118.2 Synchrophasors Data Transmission Protocol.</li> </ol> <p style="text-align: center;"><i>Note</i></p> <p><i>The UUT must be compliant with C37.118.2 to be tested by the Calibration System.</i></p>	Complete these steps in order: <ol style="list-style-type: none"> <li>1. Make sure the UUT is on.</li> <li>2. Check the Ethernet connection to the UUT. See Figure 8-1.</li> <li>3. Make sure the connection settings in the PMU Connection details area of the PMU Personality Dialog box match the UUT configuration.</li> </ol> <p style="text-align: center;"><i>Note</i></p> <p><i>The UUT must be on subnet 192.92.92. Do not use 192.92.92.1.</i></p>
This error message appears: 	<ol style="list-style-type: none"> <li>1. Incorrect PMU ID.</li> <li>2. Problem with the UUT configuration.</li> <li>3. UUT does not use C37.118.2 Synchrophasors Data Transmission Protocol.</li> </ol> <p style="text-align: center;"><i>Note</i></p> <p><i>The UUT must be compliant with C37.118.2 to be tested by the Calibration System.</i></p>	Make sure the ID number in the PMU Connection details area of the PMU Personality Dialog box match the UUT configuration.

**UUT (cont.)**

Problem	Probable Cause	Action
<p>When a test is run, an error message appears "Clock Failure – time not reliable" (For UUTs that use GPS antenna input).</p>	<p>For UUTs that are that have an internal GPS receiver, there is a problem with the GPS signal from the front panel of the 6135A/PMU System Timing Unit.</p>	<p>Complete these steps in order:</p> <ol style="list-style-type: none"> <li>1. Make sure the GPS Antenna cable to the UUT is connected to the GPS Antenna Out on the front panel of the 6135A/PMU System Timing Unit. See Figure 8-1.</li> <li>2. Check the UUT for possible indications (LEDs) that may indicate that the internal GPS is locked to a the GPS system.</li> <li>3. On the rear panel of the 6135A/PMU System Timing Unit, disconnect the "GPS Antenna In" and connect it directly to the "GPS In" on the UUT. Wait for the GPS Receiver to lock on to four satellites.               <ol style="list-style-type: none"> <li>a. If the UUT successfully locks on to four satellites, then reconnect the antenna to the "GPS Antenna In" on the rear panel of the 6135A/PMU System Timing Unit (see Figure 8-1). Reset the entire system and wait to see if the GPS Receiver locks on to satellites in the normal configuration. If 20 minutes passes and the GPS Receiver has not locked on to four satellites, contact Fluke Calibration.</li> <li>b. If the UUT does not lock on to four satellites with the antenna directly connected, check the antenna position. See the Symmetricom, GPS Receiver and Antenna Installation Manual for troubleshooting procedures.</li> </ol> </li> </ol>
<p>When a test is run, an error message appears "Clock Failure – time not reliable" (For UUTs that use IRIB-B input).</p>	<p>For UUTs that are connected to an IRIG input, there is a problem with the IRIG signal from the front panel output of the 6135A/PMU System Timing Unit.</p>	<p>Complete these steps in order:</p> <ol style="list-style-type: none"> <li>1. Make sure the IRIG-B cable to the UUT is connected to the IRIG-B OUT on the front panel of the 6135A/PMU System Timing Unit. See Figure 8-1.</li> <li>2. Check that the IRIG Present LED on the 6135A/PMU System Timing Unit front panel is illuminated.</li> <li>3. Check the UUT for possible indications (LEDs) that may indicate that the IRIG-B signal is present.</li> </ol>

**Test Reports**

Problem	Probable Cause	Action
Test Report shows multiple unexpected failures on a single phase (Voltage Phase B or Current Phase C etc.)	Voltage and current connections to the UUT do not match the UUT Personality Phase Order or a voltage connection is open circuit.	<ol style="list-style-type: none"> <li>1. Check the signal connections for the failing phase matches the UUT Personality Phase Order.</li> <li>2. For multiple Voltage Phase failures, check the corresponding connections between the 6135A and the UUT by applying a low voltage such as 10 volts to single phases one at a time. Note: consult the 6105A Users Manual to see how to manually configure and operate the 6135A from the 6105A front panel.</li> <li>3. Check for a short circuit between the Hi and Lo of the failing Current Phase. Test failures on a Current Phase cannot be caused by open circuit current connections as the 6135A/PMU Calibrator would report voltage over compliance errors and the system would stop. Failures on one Current Phase do not indicate connections are swapped with another phase or both phases would fail.</li> </ol>
Test Report shows multiple unexpected failures on two Voltage phase, two Current phases or both.	Two Voltage phases, two Current phases or both connections do not match the UUT Personality Phase Order.	<ol style="list-style-type: none"> <li>1. Check the signal connections for the failing phases match the UUT Personality Phase Order.</li> <li>2. See 2. and 3. in the previous row of this table.</li> </ol>
Test Report shows multiple unexpected failures on all Voltage phase or all Current phases or both.	All three Voltage phases, all three Current phases or all voltage and current phase connections do not match the UUT Personality Phase Order.	<ol style="list-style-type: none"> <li>1. Check the signal connections for the failing phases match the UUT Personality Phase Order.</li> <li>2. See 2. and 3. in the first row of this table.</li> </ol>

## Cleaning

For general cleaning, wipe the case, front-panel keys, and lens using a soft cloth slightly dampened with water or a non-abrasive mild cleaning solution that does not harm plastics.

### Caution

**Do not use aromatic hydrocarbons or chlorinated solvents for cleaning. They can damage the plastic materials used in the 6135A/PMU Calibration System.**

## Performance Verification and Repair Information

Annual performance verification and adjustment is recommended to verify performance to the Calibration System specifications. Fluke Calibration is the only Service Center that can adjust and repair a Calibration System. To schedule and send the Calibration System to Fluke for calibration or repair:

1. Contact a Fluke Calibration Service Center and schedule the Calibration or repair.
2. Pack and secure the Calibration System in the shipping crate that Calibration System came in.
3. Send the Calibration System to one of the Service Centers in Table 8-1.

**Table 8-1. Fluke Calibration Service Centers**

Location	Shipping Address
North America	<b>Fluke Calibration Service Center</b> 1420 75th St. SW. Everett WA 98203
Europe	<b>Fluke Calibration Service Center</b> Fluke UK Ltd 52 Hurricane Way Norwich Norfolk, NR6 6JB United Kingdom

# Chapter 9

## Performance Verification

Title	Page
About this Chapter .....	9-3
Prerequisites .....	9-3
Equipment Required .....	9-3
Procedures.....	9-3
Verify Signal Alignment with the UTC .....	9-3
Verify the Accuracy of the Timing Inputs.....	9-4
Verify Step Timing Accuracy.....	9-5
L1V Test .....	9-5
L2V .....	9-7
L3V .....	9-7



## About this Chapter

This chapter provides information on how to verify the performance of the Calibration System.

## Prerequisites

1. A recently calibrated 6105A Master Unit, and 6106A Auxiliary Units 1 and 2 installed in the Calibration System.
2. A configured and connected PMU.
3. Check functional operation by running an interactive mode Steady State test. Check the results for correct phase orientation.

## Equipment Required

1. Two channel oscilloscope with separate external trigger:
  - Channel 1 and channel 2 input impedance of 1 M $\Omega$ .
  - Auxiliary trigger input 50  $\Omega$ .
  - Channel to channel time accuracy <500 ps.
  - Channel 1 maximum peak-to-peak voltage input at least 1.41 x PMU nominal voltage (for example,  $\pm 100$  V peak for PMU with nominal voltage = 70 V).
2. Three 2 m oscilloscope BNC to BNC cables.
3. BNC tee pieces.
4. 1 m BNC to 4 mm plug cable.

## Procedures

The measurements in the following procedures are all made with the Client software that operates the Calibration System. A PMU must be connected to the system to generate responses necessary for the system to operate.

The time measurements made are externally triggered by signals that occur once per test. These trigger signals are Aux output B (Timing Unit rear panel) for alignment with UTC, and the 6105A Master Unit (rear panel). The 1 PPS signal from the GPS receiver into channel 2 is used as an absolute time reference for all time comparisons. The 1 PPS signal is available on the Calibration System Input/Output panel.

### Verify Signal Alignment with the UTC

This test measures the alignment of the  $Ref_p$  signal from the 6105A Master Unit with 1 PPS with the system frequency set to nominal (50 Hz or 60 Hz). When the phase angle of the fundamental frequency is 0°, the  $Ref_p$  crossing occurs 90° before the 1 PPS. To minimize the time difference between the signals being measured the fundamental frequency phase angle is set to -90° during the tests.

1. Set up the oscilloscope as follows:

**Table 9-1. Oscilloscope Settings**

Set	Channel 1	Channel 2	Horizontal	Trigger
Coupling	DC	DC		DC
Per division	1V	1V	200ns	
Position	-2 Div	-2 Div	Centre	Negative edge

2. Using a BNC tee piece, connect channel 1 of the oscilloscope to the Phase Reference

Output connector on the rear panel of the 6105A Master Unit (rear-panel access required). Reconnect the 6105A Master Unit to STU BNC connection via the tee piece.

3. Connect channel 2 of the oscilloscope to the 1 PPS connector on the Calibration System Input/Output panel (right side of the system).
4. Connect the external trigger input of the oscilloscope to the AUX OUT B connector on the rear panel of the Timing Unit (access from the left hand side panel of the calibration system).
5. Start the Client software and establish a connection with the PMU.
6. Select Test > Customize and Run Single Tests > Steady State Tests.
7. In the General Parameters, Test Timing menu, set Test Duration to 5 seconds.
8. In the Test Parameters menu set:
  - Input Frequency: to nominal frequency (50 or 60 Hz)
  - Phase Shift:  $-90^\circ$
  - Voltage and Magnitude Index: 100 %
  - Current and Magnitude Index: 100 %
  - Harmonic Index: 0
  - Interharmonic Index: 0
9. Select Run Test. The oscilloscope will not trigger until the AUX OUT B signal negative edge ( $T_0$ ) at the start of the test. The Voltage Positive Sequence TVE results will be plotted on the Client software as the test progresses.
10. After the trigger, measure the time from the 1 PPS positive edge to the positive edge of  $Ref_p$ . The edges will be slightly distorted due to imperfect impedance match of the oscilloscope to 6105A Master Unit  $Ref_p$  output, measure between the sharp initial transitions of the edges. Note that if the  $Ref_p$  edge occurs before the 1 PPS edge the time is negative.
11. Record the measured time as “Physical time difference” in Table 9-2.
12. The test passes if the time difference is less than  $\pm 1 \mu\text{s}$ .
13. Remove the oscilloscope external trigger input connection from AUX OUT B.

### Verify the Accuracy of the Timing Inputs

This test measures the accuracy of the time inputs STU\_T0 and STU\_TRefp data input to the mathematical model.

1. Open the file:  
C:\ProgramData\Fluke\PMUCal\Logs\T0 time stamp.txt.
2. The value “Diff” (3<sup>rd</sup> parameter) is in seconds. Record Diff in the “Model time difference” in Table 9-2. If the absolute time of STU\_Refp is earlier than STU\_T0 the time is negative.
3. Check that the difference between “Physical time difference” and “Model time difference” is less than 525 ns. Note that 525 ns is equivalent to less than 0.02 % TVE.

**Table 9-2. Time Differences**

Difference	Result	Limit
Physical time difference: (A)		$\pm 1 \mu\text{s}$
Model time difference (Diff): (B)		$\pm 1 \mu\text{s}$
A - B		$\pm 525 \text{ ns}$



### Verify Step Timing Accuracy

This test checks the latency of the step change in the 6135A analogue output with respect to the 1 PPS. The objective is to compare the time of the step with respect to the 1 PPS with the time stamp STU\_T0. Voltage phase steps of  $\pm 10^\circ$  with transitions near the zero voltage cross over are used for the tests. It is only necessary to check the step on each of the three voltage outputs to check the time error of the trigger from the STU and the delay in the 6135A trigger circuits. These time errors are common to all voltage and current outputs. Correct functioning of the current outputs can be confirmed by reference to the results of step tests on a PMU. Suitable transducers such as wide band voltage divider and current shunt with greater than 1 MHz bandwidth are required to make measurements beyond those described below.

#### Warning

**To prevent possible electrical shock, fire, or personal injury: Do not attempt to connect or disconnect any electrical connections to the UUT if a test is running. Always treat the Input/Output Panel connectors, L1, L2, and L3, as if they have hazardous voltages present.**

The 6105A TRIG OUT signal is used to trigger this measurement. The settings described below are suitable for measurements where the attached PMU nominal voltage is 70 V or 100 V. If the nominal voltage is greater than 100 V, set the nominal value to 70 V in the Client software PMU personality screen. The PMU results will not be correct but that does not matter for the purpose of these measurements.

1. Set up oscilloscope as follows:

**Table 9-3. Oscilloscope Setup**

Set	Ch1	Ch2	Horizontal	Trigger
Coupling	DC	DC		DC
Per division	10 V	1V	100 $\mu$ s	
Position	-2 Div	0 Div	Centre	Negative edge

2. Connect Ext Trig 1 of the oscilloscope to the TRIGGER OUTPUT connector on the rear panel of the 6135A System (rear-panel access required).
3. Connect Channel 2 of the oscilloscope to the 1 PPS connector on the Calibration System Input/Output panel (right side of the system).
4. Start the Client software and establish a connection with the PMU.
5. Select Test > Customize and Run Single Tests > Step Tests.
6. In the General Parameters, Test Timing menu set Test Duration to 3 seconds.

### L1V Test

1. Connect channel 1 of the oscilloscope input to the L1V connection on the Calibration System Input/Output panel (right side of the system).
2. In the Test Parameters menu set:
  - Input Frequency: to nominal frequency (50 Hz or 60 Hz)
  - Phase Shift:  $-90^\circ$
  - Phase Step Size:  $10^\circ$
  - Amplitude Step Size: 0

- Step Time: 1
  - Number of Steps: 1
3. Select Run Test.
  4. The oscilloscope will not trigger until the 6135A TRIGGER OUTPUT signal positive edge occurs at the start of the step. The Voltage Positive Sequence TVE results will be plotted on the Client software as the test progresses. The voltage step will occur exactly 1 second after the start of the test.
  5. When the oscilloscope has triggered, use the vertical cursors to measure and record in Table 9-4 the values of Ta, Tb, and Tc for L1V as shown as shown in Figure 9-1.
  6. Calculate Delay from:

$$Delay = Tb - \frac{Tb - Ta}{2} - Ta$$

**Table 9-4. Trigger Values**

	Ta	Tb	Tc	Delay	Limit
L1V (-90°)					±200 µs
L2V (+30°)					±200 µs
L3V (-30°)					±200 µs

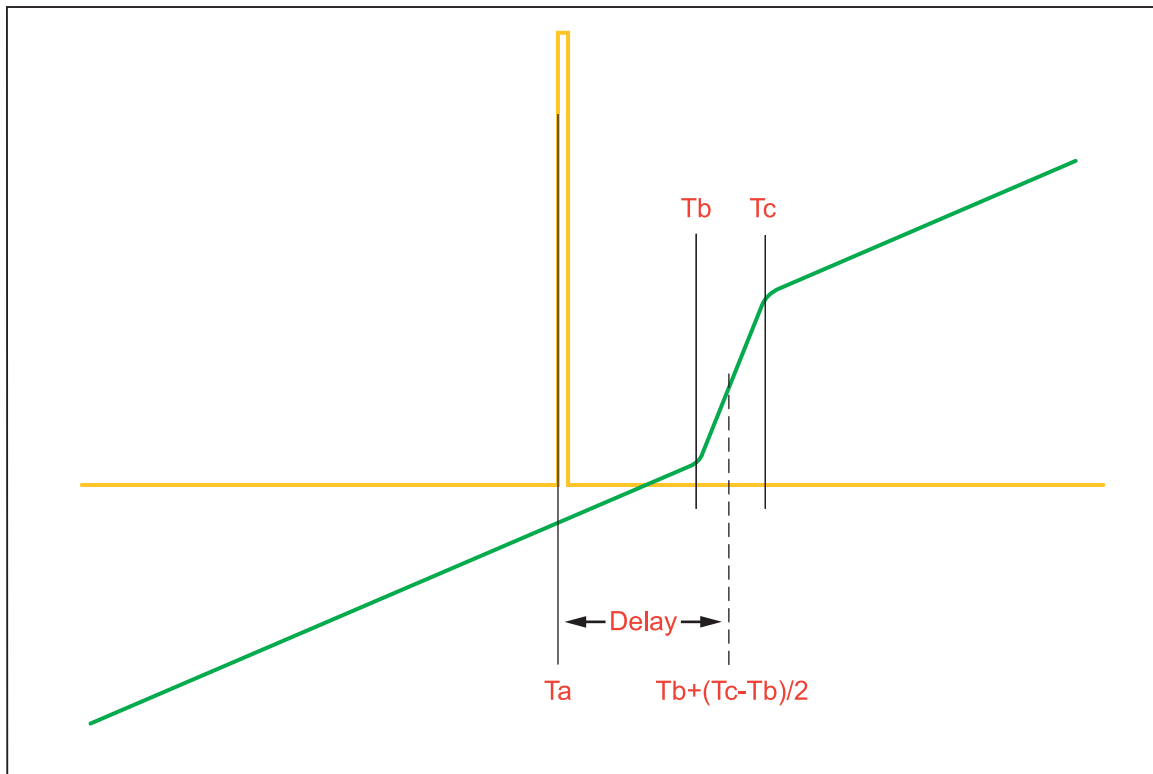

**Figure 9-1. Illustration of Plot**

gtu178.eps

7. Open the file:  
C:\ProgramData\Fluke\PMUCal\Logs\T0 time stamp.txt

8. The value “Diff” (3<sup>rd</sup> parameter) is in seconds.
9. Check that “Diff” is less than 1 $\mu$ s.
10. Close the T0 time stamp.txt file.

### L2V Test

1. Connect channel 1 of the oscilloscope input to the L2V connection on the Calibration System Input/Output panel (right side of the system).
2. In the Test Parameters menu set:
  - Input Frequency: to nominal frequency (50 Hz or 60 Hz)
  - Phase Shift: +30°
  - Phase Step Size: 10°
  - Amplitude Step Size: 0
  - Step Time: 1
  - Number of Steps: 1
3. Select Run Test.
4. When the oscilloscope has triggered, use the vertical cursors to measure and record in Table 9-4 the values of Ta, Tb, and Tc for L2V as shown as shown in Figure 9-1.
5. Open the file:  
C:\ProgramData\Fluke\PMUCal\Logs\T0 time stamp.txt
6. The value “Diff” (3<sup>rd</sup> parameter) is in seconds.
7. Check that “Diff” is less than 1 $\mu$ s.
8. Close the T0 time stamp.txt file.

### L3V Test

1. Connect the oscilloscope Channel 1 input to the L3V connection on the system connection panel.
2. In the Test Parameters pane set:
  - Input Frequency: to nominal frequency (50 Hz or 60 Hz)
  - Phase Shift: -30°
  - Phase Step Size: -10°
  - Amplitude Step Size: 0
  - Step Time: 1
  - Number of Steps: 1
3. Select Run Test.
4. When the oscilloscope has triggered, use the vertical cursors to measure and record in Table 9-4 the values of Ta, Tb, and Tc for L3V as shown as shown in Figure 9-1.
5. Open the file:  
C:\ProgramData\Fluke\PMUCal\Logs\T0 time stamp.txt.
6. The value “Diff” (3<sup>rd</sup> parameter) is in seconds.
7. Check that “Diff” is less than 1 $\mu$ s.
8. Close the T0 time stamp.txt file.
9. Remove the oscilloscope connections. Ensure all original connections are restored.
10. Replace the left side and rear panels.



# Appendix A

## Glossary

### Introduction

#### Actual Data

Reference data from the 6135A System.

#### Accuracy

The degree to which the measured value of a quantity agrees with the reference value of that quantity.

#### Automated Test

Testing method that requires no operator input to complete.

#### Automated Test List

File that contains a list of tests to be run as part of an automated test.

#### CSV

Comma-separated values file. Each line is one entry or record and the fields in a record are separated by commas.

#### Calibration Software

Fluke Calibration Software used to Calibrate a UUT.

#### Default Test Files

Test files that are made with by the Calibration Software when the software is configured for use.

#### FE

Frequency Error or “Fe” is the measure of error between the reference input frequency and the PMU measured frequency for the given instant of time in hertz per second (Hz/sec). To calculate Fe, this basic formula can be used:

$$FE = \text{Frequency Measurement Error} = |f_{\text{reference}} - f_{\text{measured}}| = |\Delta f_{\text{reference}} - \Delta f_{\text{measured}}|$$

Where:

- The measured and reference values are taken at the same instant of time.
- $\Delta f_{\text{reference}}$  is the deviation of the reference frequency from the nominal frequency.
- $\Delta f_{\text{measured}}$  is the deviation of the PMU measured frequency from the nominal frequency.

## Harmonics

A waveform that is an integral multiple of the fundamental frequency. For example, a waveform that is twice the frequency of a fundamental is called the second harmonic.

## Interactive Test

Testing method that requires the user to configure, run, and evaluate the test data.

## Measured Data

The data from the UUT.

## Measurement Latency

Latency in measurement reporting is the time delay from when an event occurs on the power system to the time that it is reported in data.

## Parameters

Independent variables in a measurement process such as temperature, humidity, test lead resistance, etc.

## Phasor

A PMU reports the phase angle and magnitude of voltage and current. The combination of phase angle and magnitude for a voltage or a current are described by a vector referred to as a “Phasor”. More formally a phasor is a complex equivalent of a sinusoidal wave quantity such that the complex modulus is the cosine wave amplitude, and the complex angle (in polar form) is the cosine wave phase angle.

## PMU Personality

The UUT personality profile is a file that stores unique information such as manufacturer information and phase order for each UUT and can be changed with the Calibration Software.

## Raw Data

Data from the 6135A System. See “Actual Data”.

## RFE

Rate of Change of Frequency Error or “RFe” is the measure of error between the input rate of change of frequency and the measured rate of change of frequency for the given instant of time in hertz per second ( $\text{Hz}/\text{sec}^2$ ). To calculate RFe, this basic formula can be used:

$$\text{RFE} = \text{Rate of change of Frequency Measurement Error} = |(\text{df}/\text{dt})_{\text{reference}} - \text{df}/\text{dt})_{\text{measured}}|$$

Where:

- $(\text{df}/\text{dt})_{\text{reference}}$  is the reference rate of change of the frequency
- $(\text{df}/\text{dt})_{\text{measured}}$  is the PMU measured rate of change of frequency

**ROCOF**

Rate of Change of Frequency or “ROCOF” is the rate that the frequency changes.

**Step Tests**

See C37.118.1 for definitions of Response Time, Delay Time and Overshoot.

**Synchrophasor**

A Phasor measurement that has a time stamp is referred to as a “Synchrophasor”.

**Testing Methods**

Type of test to be performed on the UUT. Two types are Automated and Interactive.

**TVE**

Total Vector Error or “TVE” is the measure of error between the reference phasor of the signal and actual UUT measured phasor. The phasor can be a voltage phasor or current phasor. To calculate TVE, this basic formula can be used:

$$TVE \equiv \frac{|\vec{V}_{Measured} - \vec{V}_{reference}|}{|\vec{V}_{reference}|}$$

Where:

- $\vec{V}_{reference}$  is the reference phasor
- $\vec{V}_{Measured}$  is the PMU measured phasor

**UUT (Unit Under Test)**

An abbreviated name for an instrument that is being tested or calibrated.

**XML**

Extensible markup language.

