

FLUKE®

712B

RTD Calibrator

Users Manual

January 2014

© 2014 Fluke Corporation. All rights reserved. Specifications are subject to change without notice.

All product names are trademarks of their respective companies.

LIMITED WARRANTY AND LIMITATION OF LIABILITY

This Fluke product will be free from defects in material and workmanship for three years from the date of purchase. This warranty does not cover fuses, disposable batteries, or damage from accident, neglect, misuse, alteration, contamination, or abnormal conditions of operation or handling. Resellers are not authorized to extend any other warranty on Fluke's behalf. To obtain service during the warranty period, contact your nearest Fluke authorized service center to obtain return authorization information, then send the product to that Service Center with a description of the problem.

THIS WARRANTY IS YOUR ONLY REMEDY. NO OTHER WARRANTIES, SUCH AS FITNESS FOR A PARTICULAR PURPOSE, ARE EXPRESSED OR IMPLIED. FLUKE IS NOT LIABLE FOR ANY SPECIAL, INDIRECT, INCIDENTAL OR CONSEQUENTIAL DAMAGES OR LOSSES, ARISING FROM ANY CAUSE OR THEORY. Since some states or countries do not allow the exclusion or limitation of an implied warranty or of incidental or consequential damages, this limitation of liability may not apply to you.

Fluke Corporation
P.O. Box 9090
Everett, WA 98206-9090
U.S.A.

Fluke Europe B.V.
P.O. Box 1186
5602 BD Eindhoven
The Netherlands

Table of Contents

Title	Page
Introduction	1
How to Contact Fluke.....	1
Safety Information	3
Safe Working Practices	3
Standard Equipment.....	5
Input and Output Terminals.....	7
Keys	9
Display	11
Auto Power-Off.....	13
Auto Backlight-Off	13
Contrast Adjustment.....	14
Magnet Mounting and Hanging Strap.....	15
Measure mA Current.....	16
Measure Temperature.....	16
Use Resistance-Temperature Detectors (RTDs).....	16
Set Temperature Unit	16
Source Temperature Signals.....	19
Simulate RTDs	20
Scale mA Channel to Temperature	22

Set 0 % and 100 % Output Parameters	22
Step and Ramp Modes	23
Select Step or Ramp Mode	23
Auto Storage of Settings	23
Replace the Batteries	24
Maintenance	25
Clean the Product	25
Service Center Calibration or Repair	25
Replacement Parts	26
Specifications	28
DC mA Measurement	28
Ohms Measurement	28
Ohms Source	29
RTD Input and Output	30
General Specifications	32

List of Tables

Table	Title	Page
1.	Summary of Source and Measure Functions	2
2.	International Electrical Symbols	4
3.	Input/Output Terminals and Connectors.....	8
4.	Key Functions.....	10
5.	Elements on the Display.....	12
6.	RTD Types Accepted	17
7.	Replacement Parts	26

List of Figures

Figure	Title	Page
1.	Standard Equipment.....	6
2.	Input/Output Terminals and Connectors.....	7
3.	Keys	9
4.	Elements of a Typical Display	11
5.	Adjust the Contrast.....	14
6.	Magnet Mounting with Hanging Strap	15
7.	Measure Temperature with an RTD	18
8.	Source Temperature Signals.....	19
9.	Connection for Simulating a 3 and 4 Wire RTD.....	21
10.	Replace the Batteries	24
11.	Replacement Parts	27

Introduction

Fluke 712B RTD Calibrator (the Product) is a handheld, battery-operated instrument that measures and sources a variety of RTDs. It also has an isolated channel to measure 4-20 mA. See Table 1.

How to Contact Fluke

To contact Fluke, call one of the following telephone numbers:

- Technical Support USA: 1-800-44-FLUKE (1-800-443-5853)
- Calibration/Repair USA: 1-888-99-FLUKE (1-888-993-5853)

- Canada: 1-800-36-FLUKE (1-800-363-5853)
- Europe: +31 402-675-200
- Japan: +81-03-6714-3114
- Singapore: +65-6799-5566
- Mainland China: +86-400-810-3435
- Anywhere in the world: +1-425-446-5500

Or, visit Fluke's website at www.fluke.com.

To register your product, visit <http://register.fluke.com>.

To see, print, or download the latest manual supplement, visit <http://us.fluke.com/usen/support/manuals>.

Table 1. Summary of Source and Measure Functions

Function	Measure	Source
Resistance	0 Ω to 4000 Ω	1 Ω to 4000 Ω
RTD (Resistance-Temperature Detector)	Pt100 Ω (385) Pt100 Ω (3926) Pt100 Ω (3916) Pt200 Ω (385) Pt500 Ω (385) Pt1000 Ω (385) Ni120 Ω (672) Pt10 Ω (385) Pt50 Ω (385) Cu10 Ω (427) Cu50 Ω (427) Cu100 Ω (427) YSI400	
Other functions	Step, Ramp, Isolated mA channel for 4-20 mA measurement	

Safety Information

A **Warning** identifies conditions and procedures that are dangerous to the user. A **Caution** identifies conditions and procedures that can cause damage to the Product or the equipment under test.

International electrical symbols used on the Product and in this manual are explained in Table 2.

Safe Working Practices

Review the safety information and comply with all safe working practices.

Warning

To prevent possible electrical shock, fire, or personal injury:









- Carefully read all instructions.
- Read all safety Information before you use the Product.
- Use the Product only as specified, or the protection supplied by the Product can be compromised.
- Do not use the Product around explosive gas, vapor, or in damp or wet environments.
- Never apply more than 30 V between any two terminals, or between any terminal and earth ground.

- Do not connect any test leads to voltages above 30 V when used with the product, even if ratings above 30 V appear on the test leads.
- Do not use the Product if it is damaged.
- The battery door must be closed and locked before you operate the Product.
- Remove all probes, test leads, and accessories before the battery door is opened.
- Remove the input signals before you clean the Product.
- Have an approved technician repair the Product.
- Replace the batteries when the low battery indicator shows to prevent incorrect measurements.

For safe operation and maintenance of the Product:

- Repair the Product before use if the battery leaks.
- Remove the batteries if the Product is not used for an extended period of time, or if stored in temperatures above 50 °C. If the batteries are not removed, battery leakage can damage the Product.

Table 2. International Electrical Symbols

	Earth Ground		Battery
	Conforms to relevant Australian Standards.		Risk of danger. Important information. See Manual.
	Inspected and licensed by TÜV Product Services.		Conforms to European Union directives.
CAT II	MEASUREMENT CATEGORY II is applicable to test and measuring circuits connected directly to utilization points (socket outlets and similar points) of the low voltage MAINS installation.	CAT III	MEASUREMENT CATEGORY III is applicable to test and measuring circuits connected to the distribution part of the building's low-voltage MAINS installation.
CAT IV	MEASUREMENT CATEGORY IV is applicable to test and measuring circuits connected at the source of the building's low voltage MAINS installation.		Conforms to relevant North American Safety Standards.
	This product complies with the WEEE Directive (2002/96/EC) marking requirements. The affixed label indicates that you must not discard this electrical/electronic product in domestic household waste. Product Category: With reference to the equipment types in the WEEE Directive Annex I, this product is classed as category 9 "Monitoring and Control Instrumentation" product. Do not dispose of this product as unsorted municipal waste. Go to Fluke's website for recycling information.		

Standard Equipment

The items listed below and shown in Figure 1 are included with your Product. If the Product is damaged or something is missing, contact the place of purchase immediately. To order replacement parts or spares, see the user-replaceable parts list in Table 7.

- AC175 alligator clips (2 sets)
- TL75 test leads (2 sets)
- 754-8016 alligator clips (1 set)
- Stackable test leads (1 set)
- 4 AA alkaline batteries
- Magnet Strap TPAK
- *712B/714B Safety Sheet*
- *712B Quick Reference Guide*
- *712B Users Manual (available on Fluke's website)*

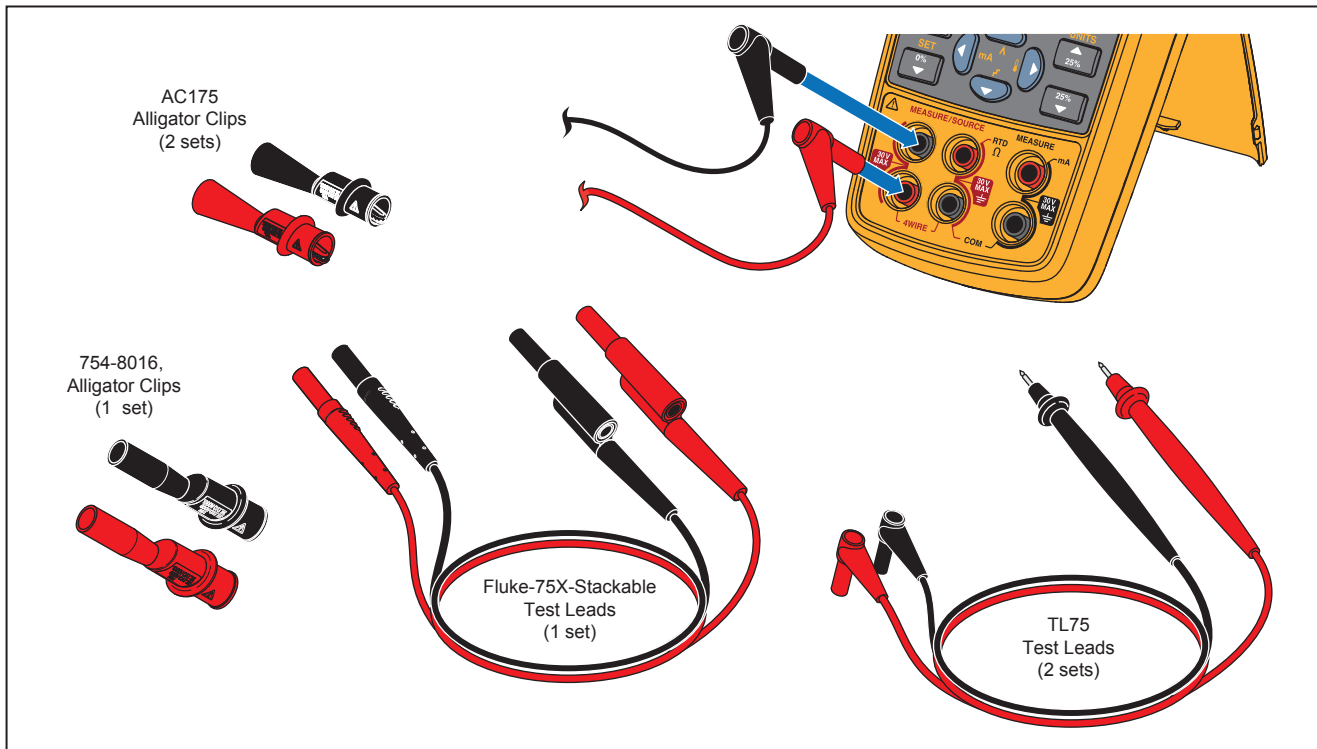

hqu01.eps

Figure 1. Standard Equipment

Input and Output Terminals

Figure 2 shows the input and output terminals on the Product. Table 3 explains their use.

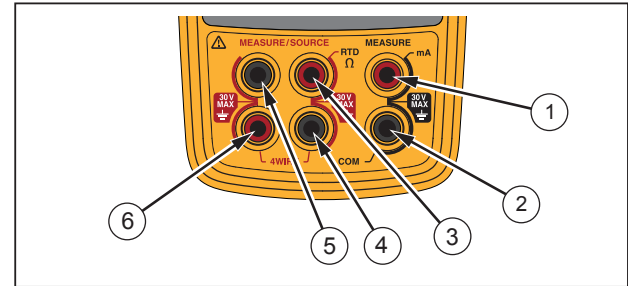

hqu02.eps

Figure 2. Input/Output Terminals and Connectors

Table 3. Input/Output Terminals and Connectors

No.	Name	Description
①, ②	Measure, mA terminals	Input terminals for measuring current.
③, ④	Source/ Measure, RTD, Ω terminals	Terminals for sourcing or measuring 2W resistance and RTDs.
⑤, ⑥	Measure 3W, 4W	Terminals for performing 3W and 4W RTD measurements.

Keys

The Product has keys for different purposes. Some keys have secondary functions that are available when SHIFT already shows on the display.



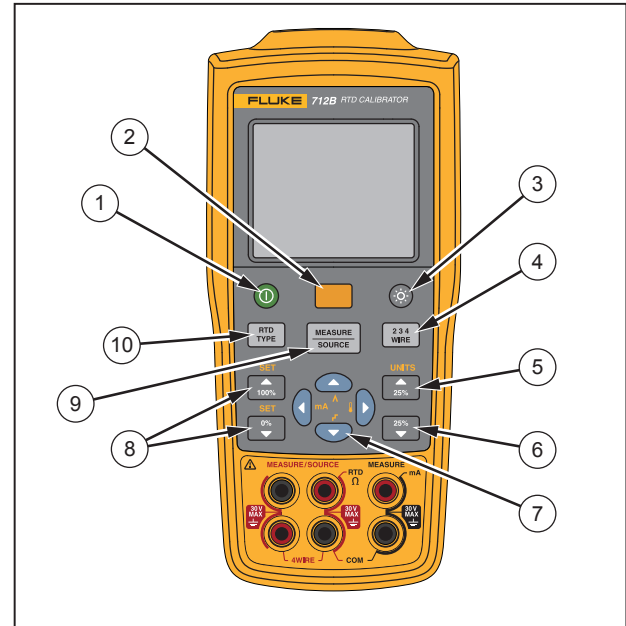







Figure 3 shows the Product keys. Table 4 explains their use.



hqu03.eps

Figure 3. Keys

Table 4. Key Functions

No.	Name	Description
①		Turns the power on or off.
②		Shifts to secondary function when pushed before other keys (Shift mode).
③		Turns backlight on or off.
④		Toggles through the 2-, 3-, and 4-wire RTD measurement mode.
⑤		Increments output by 25 % of span. Secondary function: toggles between temperature units (°C or °F.).
⑥		Decreases output by 25 % of span.
⑦		Up/down arrow increases or decreases the source level. Cycles through different options. Secondary functions: Enters Ramp or Step mode. Left/right arrow cycles through and highlights the field to be edited. In contrast adjustment mode; left- lightens contrast, right- darkens contrast. Secondary functions: Left arrow enters mA measurement; right arrow enters temperature measurement
⑧		Enables automatic value span of 100 % or 0 %. Secondary function: Sets a source value to 100 % or 0 % of span.
⑨		Shifts between Measure and Source modes.
⑩		Selects RTD (resistance temperature detector) type for measurement and sourcing functions. Secondary function: Confirms selection.

Display

Figure 4 shows the elements of a typical display. Table 5 describes the elements.

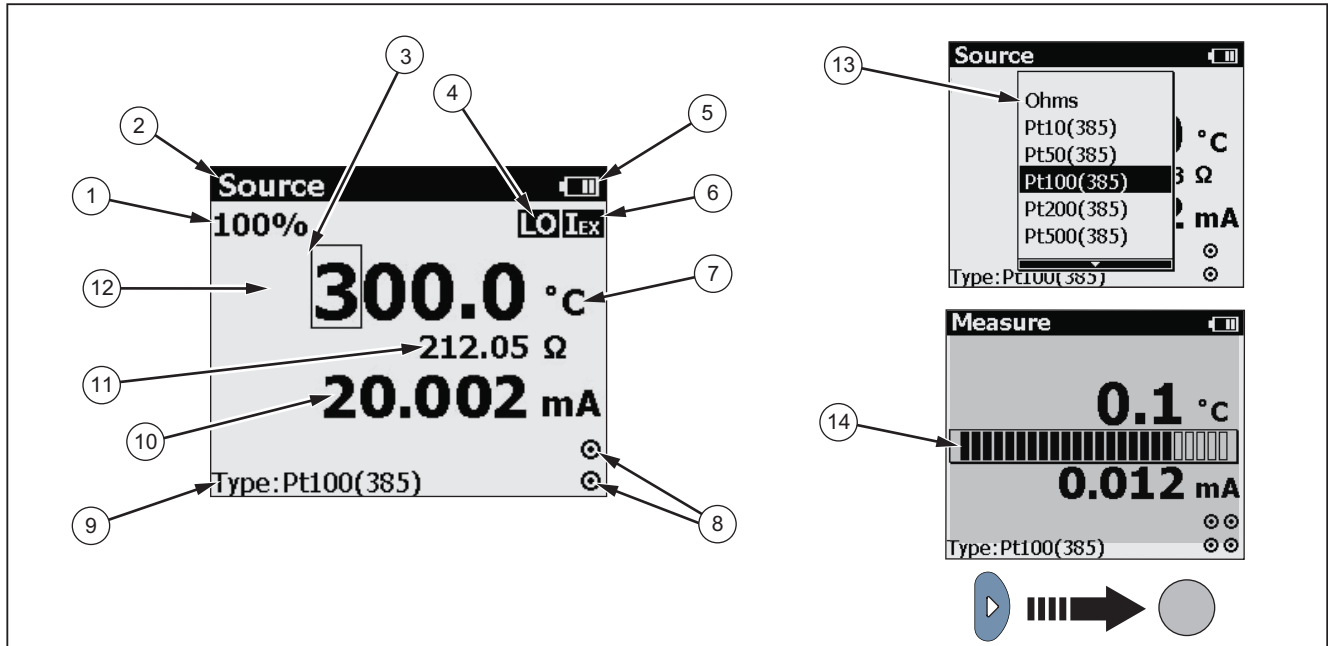

hqu19.eps

Figure 4. Elements of a Typical Display

Table 5. Elements on the Display

Item No.	Description
①	100 % of value span
②	Source or Measure mode
③	Selected digit that can be edited
④	Excitation current from the measuring device under test is too low.
⑤	Battery usage status
⑥	Excitation current from your device under test exceeds the limits of the Product.
⑦	Unit of temperature
⑧	RTD wire type
⑨	Selected RTD type
⑩	mA reading
⑪	Ω reading
⑫	Temperature reading
⑬	RTD type list
⑭	Display contrast bar

Auto Power-Off

The product provides an auto power-off function to save power. When the auto power-off mode is enabled, the Product automatically powers off after 15 minutes of inactivity.

To enable the auto power-off mode:

1. Push .
2. When SHIFT shows on the display, push RTD TYPE.
3. In the displayed setting list, highlight the **Auto poweroff** option, and then use **▶** to select this option.

To disable the the auto power-off mode:

1. Push .
2. When SHIFT shows on the display, push RTD TYPE.
3. In the displayed setting list, highlight the **Auto poweroff** option, and then use **▶** to deselect this option.

Auto Backlight-Off

The Product provides an auto backlight-off function to save power. When the auto backlight-off mode is enabled, the backlight automatically turns off after 2 minutes of inactivity.

To enable the auto backlight-off mode:

1. Push .
2. When Shift shows on the display, push RTD TYPE.
3. In the displayed setting list, highlight the **Auto backlight off** option, and then use **▶** to select this option.



To disable the the auto backlight-off mode:

1. Push .
2. When Shift shows on the display, push RTD TYPE.
3. In the displayed setting list, highlight the **Auto backlight off** option, and then use **▶** to deselect this option.

Contrast Adjustment

The Product allows you to adjust the display contrast, as shown in Figure 5.

To adjust the contrast:

1. Push  until Measure shows on the display.
2. Push  to darken contrast, or  to lighten contrast.

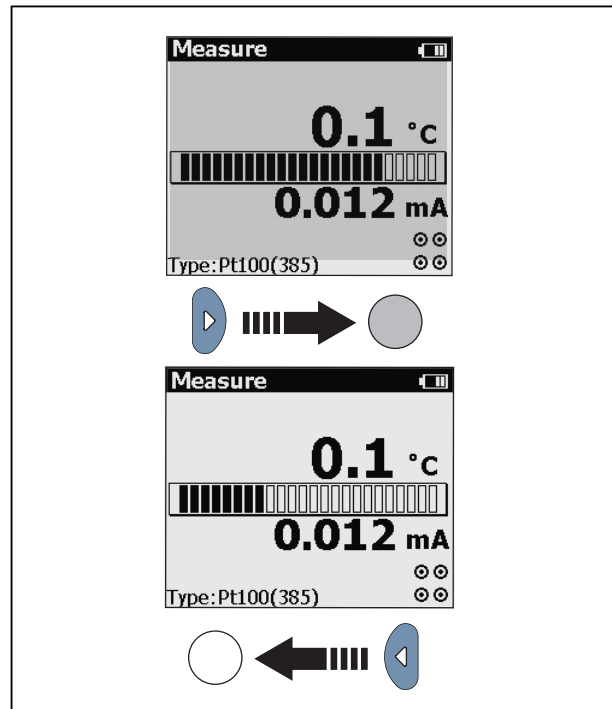

hqu18.eps

Figure 5. Adjust the Contrast

Magnet Mounting and Hanging Strap

The Product has a magnet on the rear of the unit. It is removable. This magnet enables users to mount the Product on metal environment and free their hands.

In addition, this Product has a hanging strap on the magnet. Besides its hanging purpose, the strap connects the magnet and the Product to avoid losing the magnet. This strap is also removable.

Figure 6 shows the magnet mounting of the Product with the hanging strap.

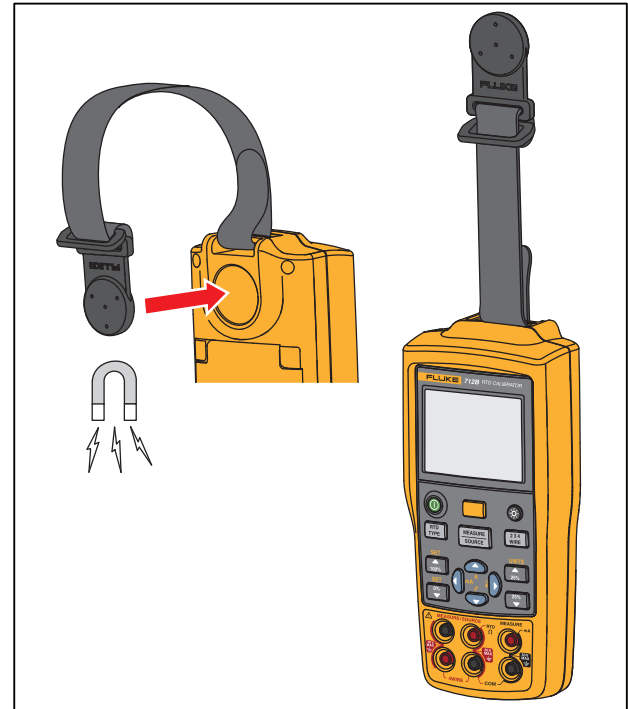

hqu16.eps

Figure 6. Magnet Mounting with Hanging Strap

Measure mA Current

To measure mA current, connect the Product to the transmitter current terminals.

Measure Temperature







Use Resistance-Temperature Detectors (RTDs)

The Product accepts RTD types shown in Table 6.

RTDs are characterized by their resistance at 0 °C (32 °F), which is called the “ice point” or R_0 .



The most common R_0 is 100 Ω . The Product accepts RTD measurement inputs in 2-, 3-, or 4-wire connections, with the 3-wire connection the most common. A 4-wire configuration provides the highest measurement precision, and 2-wire provides the lowest measurement precision.

To measure temperature using an RTD input, proceed as follows:

1. If necessary, push  for Measure mode.
2. Push .
3. Use  or  to select the desired type, and push  to confirm.
4. Push  to select a 2-, 3-, or 4- wire connection.
5. Attach the RTD to input terminals as shown in Figure 7.

Set Temperature Unit

The Product allows you to select the temperature unit °C or °F.

Push  to switch to shift mode, and push  to set the temperature unit to °C or °F.

The default temperature unit is °C.

Table 6. RTD Types Accepted

RTD Type	Ice Point (R_0)	Material	α	Range (°C)
Pt100 (3926)	100 Ω	Platinum	0.003926 $\Omega/^\circ\text{C}$	-200 to 630
Pt100 (385) ^[1]	100 Ω	Platinum	0.00385 $\Omega/^\circ\text{C}$	-200 to 800
Ni120 (672)	120 Ω	Nickel	0.00672 $\Omega/^\circ\text{C}$	-80 to 260
Pt200 (385)	200 Ω	Platinum	0.00385 $\Omega/^\circ\text{C}$	-200 to 630
Pt500 (385)	500 Ω	Platinum	0.00385 $\Omega/^\circ\text{C}$	-200 to 630
Pt1000 (385)	1000 Ω	Platinum	0.00385 $\Omega/^\circ\text{C}$	-200 to 630
Pt100 (3916)	100 Ω	Platinum	0.003916 $\Omega/^\circ\text{C}$	-200 to 630
Pt10 (385)	10 Ω	Platinum	0.00385 $\Omega/^\circ\text{C}$	-200 to 800
Pt50 (385)	50 Ω	Platinum	0.00385 $\Omega/^\circ\text{C}$	-200 to 800
Cu10 (427)	9.035 ^[2]	Copper	0.00427 $\Omega/^\circ\text{C}$	-100 to 260
Cu50 (427)	50 Ω	Copper	0.00427 $\Omega/^\circ\text{C}$	-180 to 200
Cu100 (427)	100 Ω	Copper	0.00427 $\Omega/^\circ\text{C}$	-180 to 200
YSI400				15 to 50

[1] The Pt100 commonly used in U.S. industrial applications is Pt100 (3916), $\alpha = 0.003916 \Omega/^\circ\text{C}$. (Also designated as JIS curve.) The IEC standard RTD is the Pt100 (385), $\alpha = 0.00385 \Omega/^\circ\text{C}$.

[2] 10 Ω @ 25 °C

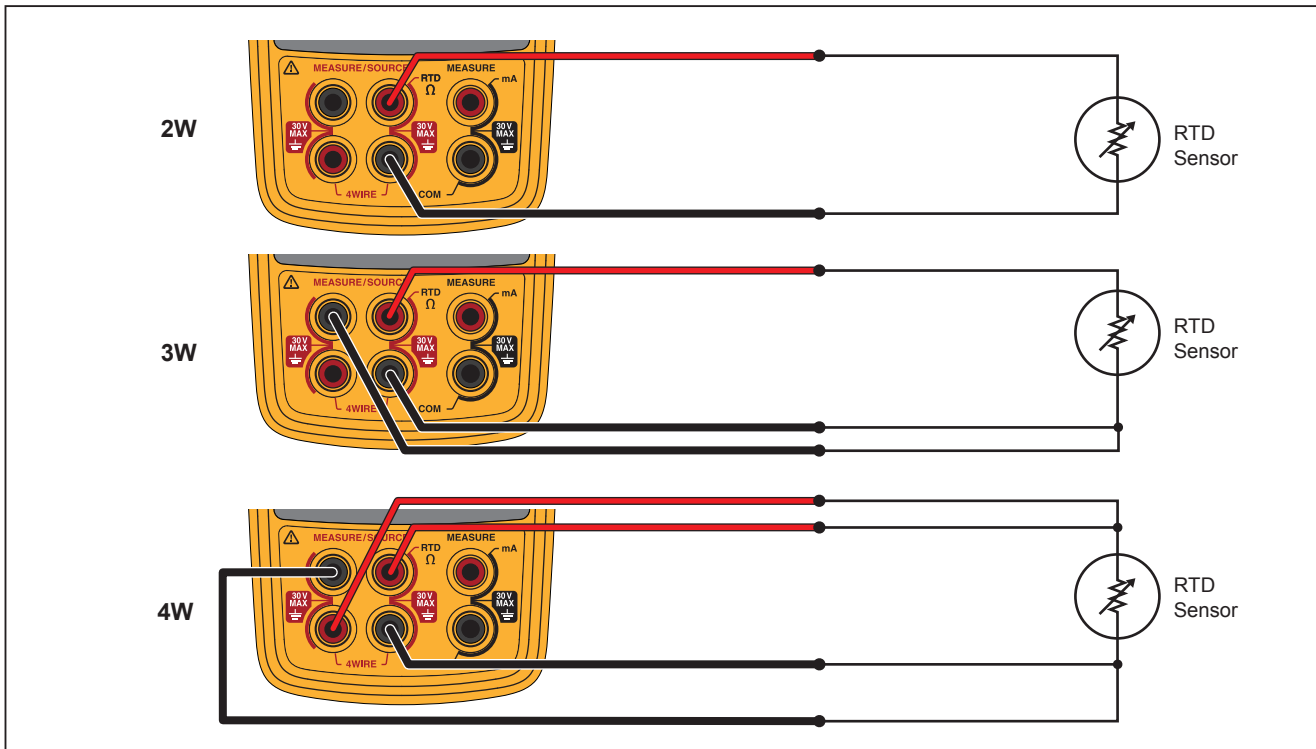

Figure 7. Measure Temperature with an RTD

hqu15.eps

Source Temperature Signals

The Product allows you to source temperature signals via sensor. See Figure 8.

1. Push **MEASURE SOURCE** to switch to Source mode on temperature channel.
2. Use the arrow keys to define the simulated temperature value.

The display shows the temperature channel with a set temperature value. Meanwhile, it shows the actual RTD Ohm value below with smaller font size.

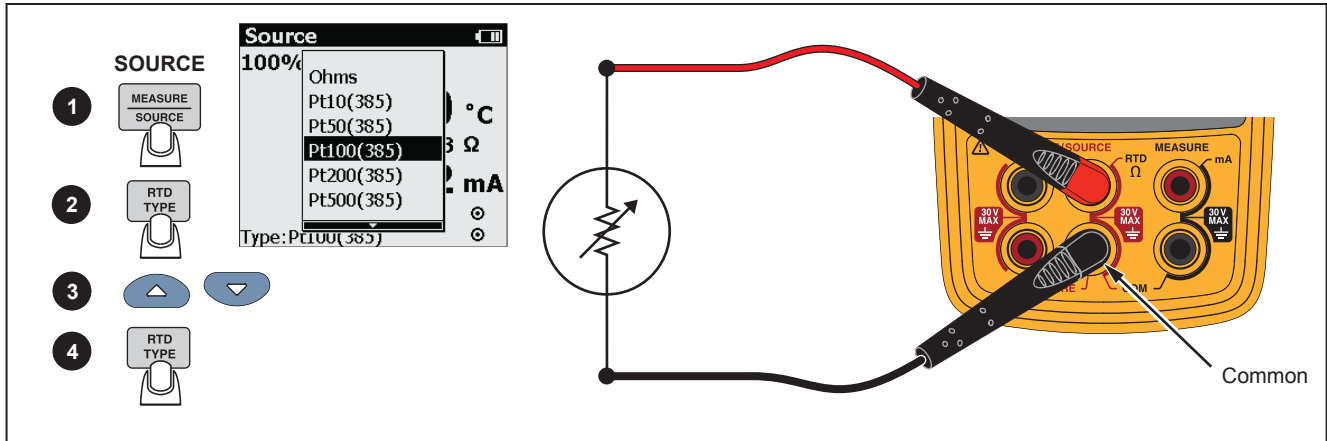

hqu09.eps

Figure 8. Source Temperature Signals





Simulate RTDs

Connect the Product to the instrument under test as shown in Figure 9. Proceed as follows to simulate an RTD:

1. If necessary, push  for Source mode.
2. Push  for the RTD display.

Note

Use the 2W, 3W, and 4W terminals for measurement only, not for simulation. The Product simulates a 2-wire RTD at its front panel. To connect to a 3-wire or 4-wire transmitter, use the stacking cables to provide the extra wires. See Figure 9.

3. Push  and  to select the temperature you want. Push  and  to select a different digit to edit.
4. If the Product display shows , the excitation current from your device under test exceeds the limits of the Product.

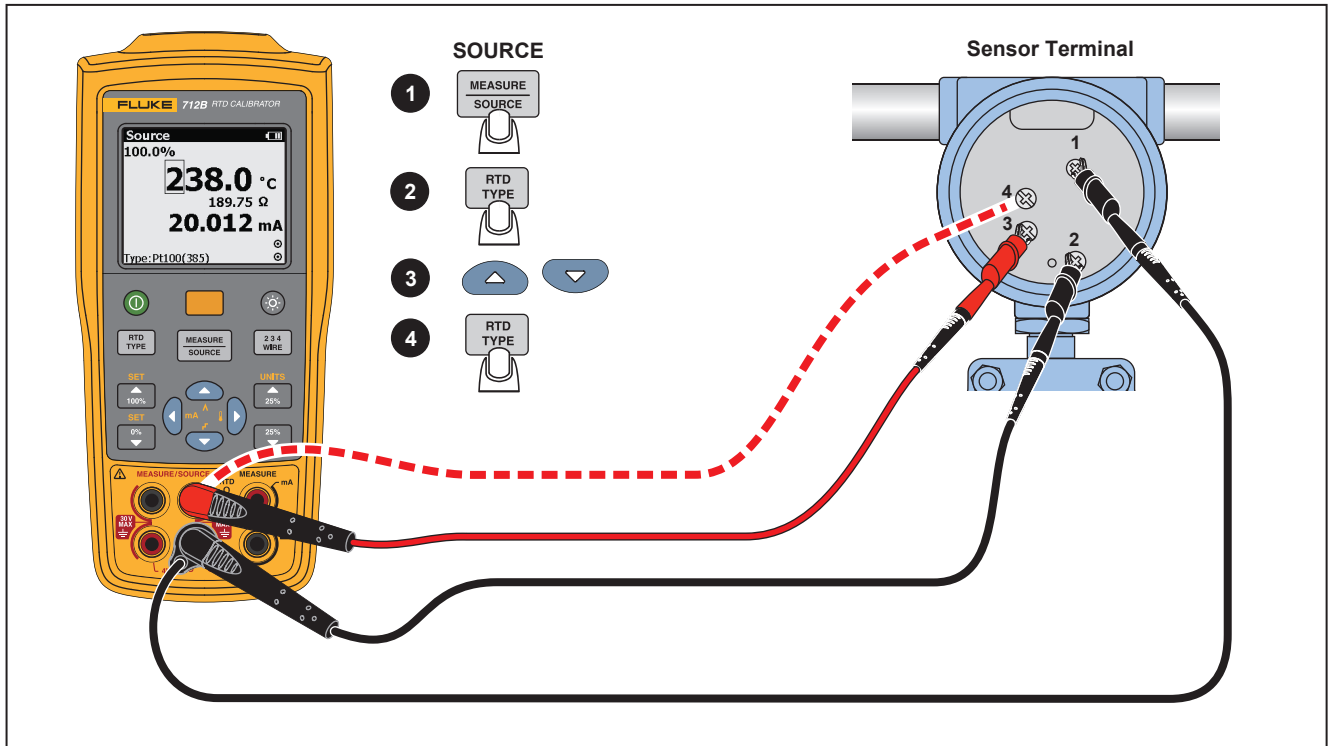



Figure 9. Connections for Simulating 3- and 4-Wire RTD

hqu11.eps

Scale mA Channel to Temperature



The Product provides a function to convert mA current channel reading to temperature reading.

To scale mA channel to temperature:

1. Push .
2. Push .

The temperature reading shows on the display.

To switch back to mA channel:

1. Push .
2. Push .

The mA current reading shows on the display.









Note

Temperature at 4 mA = Span check 0 %

Temperature at 20 mA = Span check 100 %

Set 0 % and 100 % Output Parameters

You must set the 0 % and 100 % source values before you can use the step and ramp functions. Proceed as follows:

1. If necessary, push  for Source mode.
2. Use the arrow keys to enter the value for 0 %.
3. Push  and then  to set the 0 % value.
4. Use the arrow keys to enter the value for 100 %.
5. Push  and then  to set the 100 % value.
6. Use  ,  ,  , or  to adjust the value.

Note

This function is only available when Source mode is selected.



Step and Ramp Modes

Select Step or Ramp Mode

The Product allows you to set Step and Ramp modes for easier check of points within the linear range in output mode.

To set the Step or Ramp mode:

1. Push .
2. Use  and  to select Step mode and Ramp mode.

The  or  icon shows on the Product display accordingly.

Note

This function is only available when Source mode is selected.

Auto Storage of Settings

The Product automatically stores the latest settings, including the temperature unit, the linear range of mA converting to temperature, and sensor type.

Every time you turn on the Product, it automatically applies the last settings.

Replace the Batteries

⚠ ⚠ Warning

To prevent false readings, which could lead to possible electric shock or personal injury, replace the batteries as soon as the low battery indicator appears.

Figure 10 shows you how to replace the batteries.

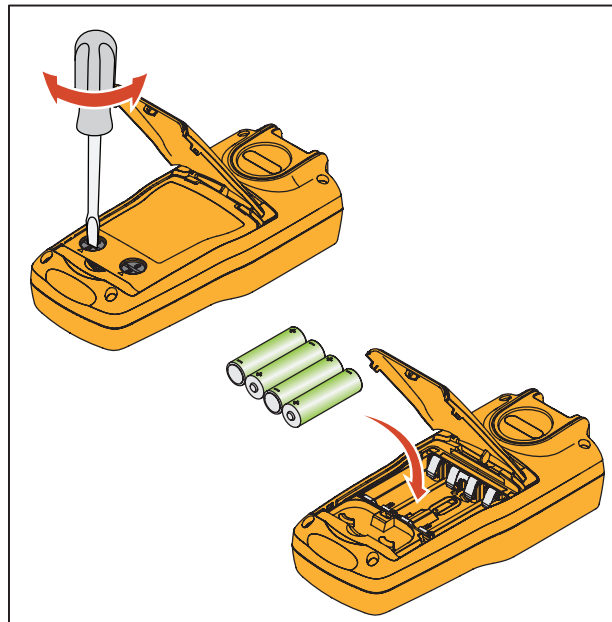

hnh38.eps

Figure 10. Replace the Batteries

Maintenance

Clean the Product

 **Warning**

To prevent personal injury or damage to the Product, use only the specified replacement parts and do not allow water into the case.

 **Caution**

To prevent damage to the plastic lens and case, do not use solvents or abrasive cleansers.

Clean the Product with a soft cloth dampened with water or water and mild soap.

Service Center Calibration or Repair

Calibration, repairs, or servicing not covered in this manual should be performed only by qualified service personnel. If the Product fails, check the batteries first, and replace them if needed.

Verify that the Product is being operated in accordance with the instructions in this manual. If the Product is faulty, send a description of the failure with the Product. Be sure to pack the Product securely, using the original shipping container if it is available. Send the equipment postage paid and insured, to the nearest Service Center. Fluke assumes no responsibility for damage in transit.

To locate an authorized service center, refer to “How to Contact Fluke” at the beginning of the manual.

Replacement Parts

Table 7 lists the part number of each replaceable part. Refer to Figure 11.

Table 7. Replacement Parts

Item	Description	PN	Qty.
①	Case top	4307068	1
②	Decal	4307164	1
③	Keypad	4307147	1
④	Keypad support	4307112	1
⑤	Screw, M2.2 x 0.8, 5 MM, PAN, PHILLIPS	2032777	10
⑥	LCD mask	4307101	1
⑦	LCD protect rubber	4307208	1
⑧	LCD	4313462	1
⑨	Support LCD gasket	4307213	1
⑩	Screw, M3 x 0.5,5MM, PAN, PHILLIPS	2032811	6

⑪	Case seal rubber	4307186	1
⑫	Case bottom assembly	4307079	1
⑬	Screw, M3, 13.5 mm, PAN, PHILLIPS	2388382	6
⑭	Battery door seal rubber	4307199	1
⑮	AA battery	376756	4
⑯	Pad, battery door	4417921	1
⑰	Battery door assembly	4376901	1
⑱	Bail stand	4307093	1
⑲	Quick Reference Guide	4285042	1
--	754-8016 alligator clip set, not shown	4253535	1
--	Stackable test lead set, not shown	3669716	1
--	Test Leads, not shown	variable ^[1]	2 sets
--	Alligator Clips, not shown	variable ^[1]	2 sets

[1] See www.fluke.com for more information about the test leads and alligator clips available for your region.

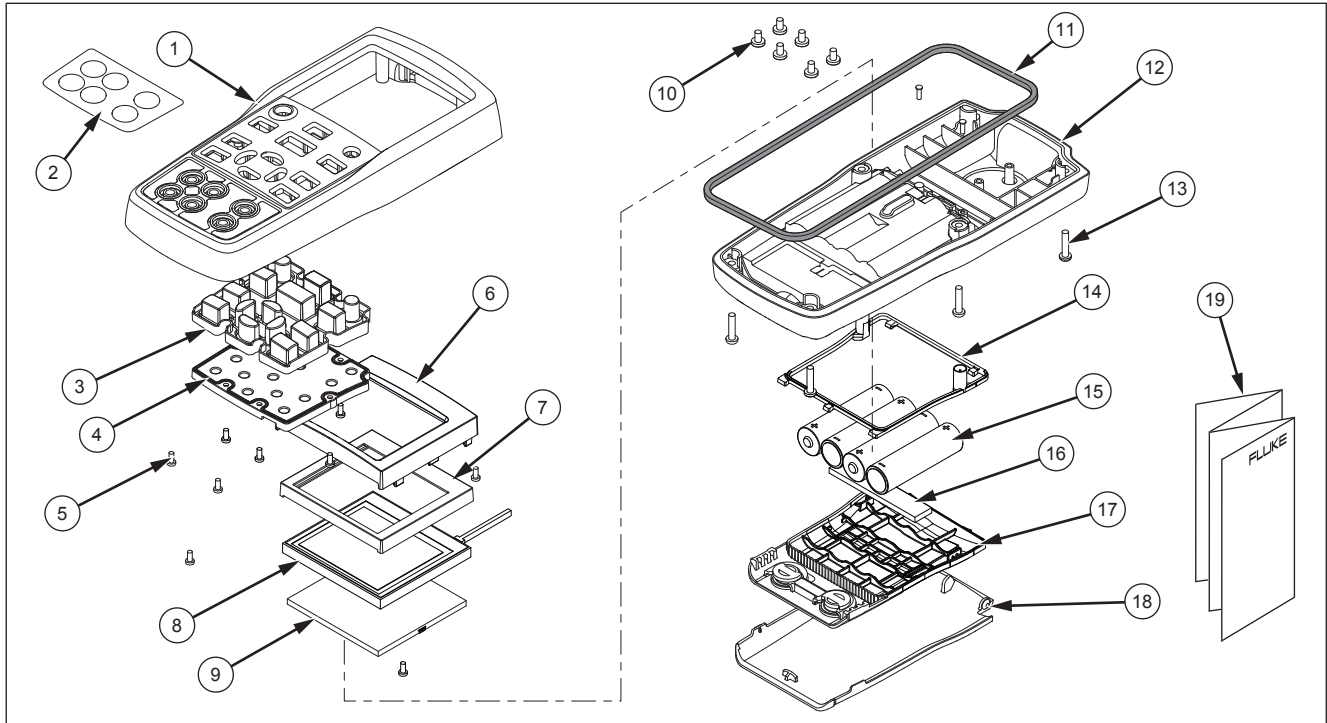

hqu46.eps

Figure 11. Replacement Parts

Specifications

Specifications are based on a one year calibration cycle and apply from +18 °C to +28 °C unless stated otherwise. All specifications assume a 5 minute warmup period.

DC mA Measurement

Range	Resolution	Accuracy (% of Reading + Floor)	
		1 year	2 year
0-24 mA	0.001 mA	0.01 % + 2 μ A	0.02 % + 4 μ A
Note: Temperature coefficient: $\pm(0.002\% \text{ of reading} + 0.002\% \text{ of range})/^{\circ}\text{C}$ (<18°C or >28°C)			

Ohms Measurement

Range	Resolution	Accuracy (% of Reading + Floor)	
		1 year	2 year
0.00 Ω to 400.00 Ω	0.01 Ω	0.015 % + 0.05 Ω	0.03 % + 0.08 Ω
400.0 Ω to 4000.0 Ω	0.1 Ω	0.015 % + 0.5 Ω	0.03 % + 0.8 Ω
Note: 1) Read accuracy is based on 4-wire input. For 3-wire ohm measurements, assuming all three leads are matched, add 0.05 Ω (0.00 Ω ~400.00 Ω), 0.2 Ω (400.0 Ω ~4000.0 Ω) to the specifications. 2) Temperature Coefficient: $\pm(0.002\% \text{ of reading} + 0.002\% \text{ of range})/^{\circ}\text{C}$ (<18 °C or >28 °C)			

Ohms Source

Ohms Range	Excitation Current from Measurement Device	Accuracy (% of Output + Floor)	
		1 year	2 year
1.0 Ω to 400.0 Ω	0.1 mA to 0.5 mA	0.015 % + 0.1 Ω	0.03 % + 0.2 Ω
1.00 Ω to 400.00 Ω	0.5 mA to 3 mA	0.015 % + 0.05 Ω	0.03 % + 0.08 Ω
400.0 Ω to 1500.0 Ω	0.05 mA to 0.8 mA	0.015 % + 0.5 Ω	0.03 % + 0.8 Ω
1500.0 Ω to 4000.0 Ω	0.05 mA to 0.4 mA	0.015 % + 0.5 Ω	0.03 % + 0.8 Ω
Resolution			
1.00 Ω to 400.00 Ω	0.01 Ω		
400.0 Ω to 4000.0 Ω	0.1 Ω		
Notes:			
1) Supports pulsed transmitters and PLCs with pulse times as short as 5 ms.			
2) Temperature coefficient: ± (0.002 % of output + 0.002 % of range) /°C (<18 °C or >28 °C)			

RTD Input and Output

RTD Type (α)	Range (°C)	Measure (°C)			Source (°C)	
		1 year	2 year	Source Current	1 year	2 year
10 Ω Pt(385)	-200 to 100	1.5	3	1 mA	1.5	3
	100 to 800	1.8	3.6	1 mA	1.8	3.6
50 Ω Pt(385)	-200 to 100	0.4	0.7	1 mA	0.4	0.7
	100 to 800	0.5	0.8	1 mA	0.5	0.8
100 Ω Pt(385)	-200 to 100	0.2 °C	0.4 °C	1 mA	0.2 °C	0.4 °C
	100 to 800	0.015 %+0.18 °C	0.03 %+0.36 °C		0.015 %+0.18 °C	0.03 %+0.36 °C
200 Ω Pt(385)	-200 to 100	0.2 °C	0.4 °C	500 μ A	0.2 °C	0.4 °C
	100 to 630	0.015 %+0.18 °C	0.03 %+0.36 °C		0.015 %+0.18 °C	0.03 %+0.36 °C
500 Ω Pt(385)	-200 to 100	0.3 °C	0.6 °C	250 μ A	0.3 °C	0.6 °C
	100 to 630	0.015 %+0.28 °C	0.03 %+0.56 °C		0.015 %+0.28 °C	0.03 %+0.56 °C
1000 Ω Pt(385)	-200 to 100	0.2 °C	0.4 °C	250 μ A	0.2 °C	0.4 °C
	100 to 630	0.015 %+0.18 °C	0.03 %+0.36 °C		0.015 %+0.18 °C	0.03 %+0.36 °C

100 Ω Pt(3916)	-200 to 100	0.2 °C	0.4 °C	1 mA	0.2 °C	0.4 °C
	100 to 630	0.015 %+0.18 °C	0.03 %+0.36 °C		0.015 %+0.18 °C	0.03 %+0.36 °C
100 Ω Pt(3926)	-200 to 100	0.2 °C	0.4 °C	1 mA	0.2 °C	0.4 °C
	100 to 630	0.015 %+0.18 °C	0.03 %+0.36 °C		0.015 %+0.18 °C	0.03 %+0.36 °C
10 Ω Cu(427)	-100 to 260	1.5	3	1 mA	1.5	3
120 Ω Ni(672)	-80 to 260	0.15	0.3	1 mA	0.15	0.3
50 Ω Cu(427)	-180 to 200	0.4	0.7	1 mA	0.4	0.7
100 Ω Cu(427)	-180 to 200	0.2	0.4	1 mA	0.2	0.4
YSI400	15 to 50	0.2	0.4	250 μA	0.2	0.4

- 1) Sensor inaccuracies not included.
- 2) Resolution: 0.1 °C.
- 3) Read accuracy is based on 4-wire input. For 3-wire RTD measurements, assuming all three RTD leads are matched, add 1.0 °C (Pt10 and Cu10), 0.6 °C (Pt50 and Cu50), 0.4 °C (Other RTD types) to the specifications.
- 4) Source Accuracy in source mode is based on 0.5 mA~3 mA (1.00 Ω~400.00 Ω), 0.05 mA~0.8 mA (400.0 Ω~1500.0 Ω), 0.05 mA~0.4 mA (1500.0 Ω~4000.0 Ω), excitation current (0.25 mA for Pt1000 range).
- 5) Temperature Coefficient: ±0.05 °C /°C for measure, ± 0.05 °C /°C (<18 °C or >28 °C) for source.
- 6) Supports pulsed transmitters and PLCs with pulse times as short as 5 ms.

General Specifications

Maximum voltage applied between any terminal and earth ground or between any two terminals:	30 V
Operating temperature	-10 °C to 50 °C
Storage temperature	-20 °C to 60 °C
Operating altitude	2,000 meters
Storage altitude	12,000 meters
Relative Humidity (% RH operating without condensation)	Non condensing 90 % (10 °C to 30 °C) 75 % (30 °C to 40 °C) 45 % (40 °C to 50 °C) (Without condensation)
Vibration Requirements	MIL-T-28800E, Class 2
Drop Test Requirements	1 meter
IP Rating	IEC 60529: IP52
Electromagnetic Environment	IEC 61326-1, Portable
Safety	IEC 61010-1, Max 30 V to earth, Pollution Degree 2
Power Supply	4 AA alkaline batteries/NEDA code: 15A, IEC code: LR6
Size (H x W x L)	52.5 x 84 x 188.5 mm
Weight	524 g