

Declaration of Conformity

We
GOOD WILL INSTRUMENT CO., LTD.
 No. 7-1, Jhongsing Rd., Tucheng City, Taipei County 236, Taiwan
GOOD WILL INSTRUMENT (SUZHOU) CO., LTD.
 No.69 Lushan Road, Suzhou New District Jiangsu, China.
 declares that the below mentioned product
PSH-1036/2018/3610/6006
PSH-1070/2035/3620/6012
PSH-10100/2050/3630/6018
 are herewith confirmed to comply with the requirements set out in the Council Directive on the Approximation of the Law of Member States relating to Electromagnetic Compatibility (89/336/EEC, 92/31/EEC, 93/68/EEC) and Low Voltage Equipment Directive (73/23/EEC). For the evaluation regarding the Electromagnetic Compatibility and Low Voltage Equipment Directive, the following standards were applied:

◎ EMC

EN 61326-1: Electrical equipment for measurement, control and laboratory use — EMC requirements (1997+A1: 1998)	
Conducted and Radiated Emissions EN 55011: 1991+A1: 1997+A2: 1996	Electrostatic Discharge EN 61000-4-2: 1995+A1:1998
Current Harmonic EN 61000-3-2: 1995+A1: 1998+A2: 1998 +A14: 2000	Radiated Immunity EN 61000-4-3: 19965+A1:1998
Voltage Fluctuation EN 61000-3-3: 1995	Electrical Fast Transients EN 61000-4-4: 1995
-----	Surge Immunity EN 61000-4-5: 1995
-----	Conducted Susceptibility EN 61000-4-6: 1996
-----	Voltage Dips/ Interrupts EN 61000-4-11: 1994

◎ Safety

Low Voltage Equipment Directive 73/23/EEC & amended by 93/68/EEC
IEC/EN 61010-1 :2001

CONTENTS	PAGE
1. PRODUCT INTRODUCTION.....	1
1-1. Description.....	1
1-2. Features.....	1
2. TECHNICAL SPECIFICATIONS.....	3
3. PRECAUTIONS BEFORE OPERATION.....	6
3-1. Unpacking the Instrument.....	6
3-2. Checking the Line Voltage.....	6
3-3. Environment.....	7
4. PANEL INTRODUCTION.....	8
5. OPERATION METHOD.....	13
5-1. Constant Voltage/Constant Current Crossover Characteristic.....	13
5-2. Output Voltage/Current Setting.....	14
5-3. Over Voltage/Current Protection Setting.....	16
5-4. Display Contrast Setting.....	16
5-5. Buzzer Setting.....	16
5-6. GPIB/RS-232 Interface Setting.....	16
5-7. Remote Error Sensing.....	17
5-8. Test Lead Selective Table.....	19
6. MAINTENANCE.....	20
6-1. Adjustment and Calibration.....	20
6-2. Cleaning.....	23
7. THE SYSTEM DIAGRAM AND DESCRIPTION.....	24
7-1.Block Diagram.....	24
7-2.The Configuration of PSH-series Block System.....	25
8. APPENDIX: RACK-MOUNTING.....	26

SAFETY TERMS AND SYMBOLS

These terms may appear in this manual or on the product:



WARNING. Warning statements identify condition or practices that could result in injury or loss of life.



CAUTION. Caution statements identify conditions or practices that could result in damage to this product or other property.

The following symbols may appear in this manual or on the product:



DANGER
High Voltage



ATTENTION
refer to Manual



Protective
Conductor
Terminal



Earth (ground)
Terminal



Frame or Chassis
Terminal

FOR UNITED KINGDOM ONLY

NOTE: This lead/appliance must only be wired by competent persons

WARNING: THIS APPLIANCE MUST BE EARTHED

IMPORTANT: The wires in this lead are coloured in accordance with the following code:

Green/ Yellow:	Earth
Blue:	Neutral
Brown:	Live (Phase)

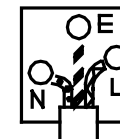

As the colours of the wires in main leads may not correspond with the colours marking identified in your plug/appliance, proceed as follows:

The wire which is coloured Green & Yellow must be connected to the Earth terminal marked with the letter E or by the earth symbol  or coloured Green or Green & Yellow.

The wire which is coloured Blue must be connected to the terminal which is marked with the letter N or coloured Blue or Black.

The wire which is coloured Brown must be connected to the terminal marked with the letter L or P or coloured Brown or Red.

If in doubt, consult the instructions provided with the equipment or contact the supplier.

This cable/appliance should be protected by a suitably rated and approved HBC mains fuse: refer to the rating information on the equipment and/or user instructions for details. As a guide, cable of 0.75mm² should be protected by a 3A or 5A fuse. Larger conductors would normally require 13A types, depending on the connection method used.

Any moulded mains connector that requires removal /replacement must be destroyed by removal of any fuse & fuse carrier and disposed of immediately, as a plug with bared wires is hazardous if a engaged in live socket. Any re-wiring must be carried out in accordance with the information detailed on this label.

1. PRODUCT INTRODUCTION

1-1. Description

PSH-series Programmable Power Supply is controlled by Micro Processor Unit (MPU) that can easily connect communication interface RS-232 or GPIB to computer in order to satisfy user's demands for auto-testing and auto-control. Beside, it can also be mounted in a standard 19-inches rack cabinet using one of our GRA-403 optional kits. The series of products have improved greatly the shortage of the traditional big size, heavy weight products.

The voltage and current are completely controlled by 12 bits D/A Converter with higher resolution and accuracy. Also, the digitalization of system makes a speedy, precise and convenient input of information controlled by the keyboard and rotation knobs.

The adjustment of voltage/current is made by software calibration without manual error that will increase the preciseness of the instrument.

The function of Over Voltage Protection (OVP) and Over Current Protection (OCP) is set with software and detected with hardware to achieve protected function precisely and speedily in order to prevent users from danger by using the instrument.

1-2. Features

- 1) Wide Input Voltage Range and High Power Factor (P.F).
- 2) High Efficiency.
- 3) Constant Voltage and Constant Current Operation.
- 4) The protection for Over Voltage, Over Current and Over Heat.

- 5) IEEE-488.2 and SCPI Compatible Command set.
- 6) Remote Control.
- 7) Output On/Off Control.
- 8) Self-test and Software Calibration.
- 9) LCD Display.
- 10) Built-in Buzzer Alarm.
- 11) Select either RS-232C(standard) or GPIB(option).

2. TECHNICAL SPECIFICATIONS

The minimum working voltage for PSH-6018/6012/6006/3630/3620/3610 is at 3V, and for PSH-2050/2035/2018/10100/1070/1036 is at 10% of the maximum output voltage.

SPEC.	MODEL	10V	PSH-1036(36A)	PSH-1070(70A)	PSH-10100(100A)
		20V	PSH-2018(18A)	PSH-2035(35A)	PSH-2050(50A)
		36V	PSH-3610(10A)	PSH-3620(20A)	PSH-3630(30A)
		60V	PSH-6006(6A)	PSH-6012(12A)	PSH-6018(18A)
	Regulation (C.V)	Load	$\leq 0.1\%+5mV$		
	Line	$\leq 0.05\%+5mV$			
Regulation (C.C)	Load	$\leq 0.2\%+5mA$	$\leq 0.2\%+10mA$	$\leq 0.2\%+15mA$	
	Line	$\leq 0.2\%+5mA$	$\leq 0.2\%+10mA$	$\leq 0.2\%+15mA$	
Ripple & Noise	Voltage(mVrms)	$\leq 10mVrms, 100mVpp 20Hz\sim 20MHz$			
	Current(mArms)	$\leq 0.2\%$	$\leq 0.2\%+20mA$	$\leq 0.2\%+40mA$	
Program Accuracy	Voltage	$\leq 0.05\%+25mV$	Rating Voltage: $\leq 36V$		
	OVP	$\leq 0.05\%+50mV$	Rating Voltage: $>36V$		
	Current	10V	$\leq 0.2\%+30mA$	$\leq 0.2\%+60mA$	$\leq 0.2\%+90mA$
		20V	$\leq 0.2\%+30mA$		$\leq 0.2\%+60mA$
		36V	$\leq 0.2\%+30mA$		
60V		$\leq 0.2\%+30mA$			
Program Resolution	Voltage	10mV	Rating Voltage: $\leq 36V$		
	OVP	20mV	Rating Voltage: $>36V$		
	Current	10V	10mA	20mA	30mA
		20V	10mA		20mA
		36V	10mA		
60V		10mA			

SPEC. / MODEL	10V		PSH-1036(36A)		PSH-1070(70A)		PSH-10100(100A)	
	20V		PSH-2018(18A)		PSH-2035(35A)		PSH-2050(50A)	
	36V		PSH-3610(10A)		PSH-3620(20A)		PSH-3630(30A)	
	60V		PSH-6006(6A)		PSH-6012(12A)		PSH-6018(18A)	
Readback(Meter)	Voltage	≤36V	≤0.05%+25mV					
		>36V	≤0.05%+50mV					
Accuracy	Current	10V	≤0.2%+30mA	≤0.2%+60mA	≤0.2%+90mA			
		20V	≤0.2%+30mA			≤0.2%+60mA		
		36V	≤0.2%+30mA					
		60V	≤0.2%+30mA					
Readback(Meter)	Voltage	≤36V	10mV					
		>36V	20mV					
Resolution	Current	10V	10mA	20mA	30mA			
		20V	10mA			20mA		
		36V	10mA					
		60V	10mA					
Recovery Time (50% step load change from 25%~75%)	CV Mode	≤2ms						
Response Time	Voltage Up (10%~90% ≤ 95% rating load)	≤150ms						
	Voltage Down (90%~10%, ≥ 10% rating load)	≤150ms						

SPEC. / MODEL	10V		PSH-1036(36A)		PSH-1070(70A)		PSH-10100(100A)	
	20V		PSH-2018(18A)		PSH-2035(35A)		PSH-2050(50A)	
	36V		PSH-3610(10A)		PSH-3620(20A)		PSH-3630(30A)	
	60V		PSH-6006(6A)		PSH-6012(12A)		PSH-6018(18A)	
Temperature Coefficient	Voltage (25±5°C)	≤100ppm/°C						
Protection	OVP/OCP/OHP	Provided						
	Inrush Current Protection	Provided						
Output ON/OFF Control	Provided							
Display	LCD	LCD	LCD	LCD				
Mechanical Spec.	Dimensions (W×H×D)	108×141×388 m/m	188×141×388 m/m	268×141×388 m/m				
	Weight	Approx. 3.3 kg	Approx. 6.2 kg	Approx. 9.3 kg				
AC Input	100-230V							
Operation Environmental	Indoor use Altitude up to 2000 m Ambient temperature: To satisfy specifications : 10°C to 35°C (50° F to 95°F) Maximum operating ranges: 0°C to 40°C (32°F to 104°F) Relative humidity: 85% RH(max.) non condensing Installation Category : II Pollution degree 2							
Storage Temperature & Humidity	-10° to 70°C , 70%RH (maximum)							
Accessories	Instruction manual × 1, Programmable Manual × 1 Cable Gland × 1, AC Power cord × 1 AC Input Cover × 1, O/P Terminal Cover × 1							

3. PRECAUTIONS BEFORE OPERATION

3-1. Unpacking the Instrument

The product has been fully inspected and tested before shipping from the factory. Upon receiving the instrument, please unpack and inspect it to check if there is any damage caused during transportation. If any sign of damage is found, notify the bearer and/or the dealer immediately.

3-2. Checking the Line Voltage

The product can be applied to 100V~230VAC voltages shown in the table below.



WARNING. To avoid electrical shock the power cord protective grounding conductor must be connected to ground.

AVERISS: Pour éviter les chocs électriques, le fil de terre du cordon secteur doit impérativement être relié à la terre.

Replace the required fuses according to the table below:

Model	AC Input	AC Input Range	Fuse
PSH-1036(36A)	100~230V AC	90~250VAC	6.3A/250VAC ×2
PSH-2018(18A)			
PSH-3610(10A)			
PSH-6006(6A)			
PSH-1070(70A)	100~230V AC	90~250VAC	6.3A/250VAC ×2 0.5A/250VAC ×1 15A/250VAC ×1
PSH-2035(35A)			
PSH-3620(20A)			
PSH-6012(12A)			

PSH-10100(100A)	100~230VAC	90~250VAC	6.3A/250VAC ×3 0.5A/250VAC ×1 20A/250VAC ×1
PSH-2050(50A)			
PSH-3630(30A)			
PSH-6018(18A)			



WARNING. To avoid personal injury, disconnect the power cord before removing the fuse holder.

3-3. Environment

The normal ambient temperature range of this instrument is from 0° to 40°C (32° to 104°F). To operate the instrument exceeding this specific temperature range may cause damage to the circuits of instrument.

Do not use the instrument in a place where strong magnetic or electric field exists as it may disturb the measurement.



CAUTION : To avoid damaging the instrument, do not use it in a place where ambient temperature exceeds 40°C .



WARNING: This is a Class A product. In a domestic environment this product may cause radio interference in which case the user may be required to take adequate measures.



WARNING: The models PSH-10100, PSH-2050, PSH-3630 and PSH-6018 should be operated with input breaker current capacity over 20A.

4. PANEL INTRODUCTION

1. Display Indicate the setting of voltage/current value, output voltage/current value and the status of setting and output.
2. Power Switch Connect the AC power, then press power switch.
3. Rotary Encoder Wheel knob.
4. Output Turn on or off output by pressing the knob.
5. V_{set}/I_{set}
(ENTER) Output voltage and Output current switched setting.
[ENTER]: This key is for digit value input or setting confirmation.
6. F/C Switch to wheel knob for coarse and fine adjustment.
7. MENU The selection menu for function setting.
PS. If there is no further setting change after switching to MENU 4~5 seconds, it will be back to the previous window or output display window.
8. Local
(GPIB/RS-232) This key has two function:
 1. Clear the remote control and replace with panel control setting.
 2. Clear the protection status of power supply.
PS. Press and hold the key for 5 seconds to get into calibration mode.
9. Cooling Fan A cooling fan.
10. GND Terminal Connect the ground terminal to chassis.
11. +Output Terminal Positive output terminal.
- Output Terminal Negative output terminal.
12. S+ : a positive input voltage remote sense terminal.
S- : a negative input voltage remote sense terminal.
M+ : a positive output voltage monitoring Terminal.
M- : a negative output voltage monitoring terminal.
13. Interface : GPIB or RS-232 communication interface.

14. AC Power Terminal : AC power input terminal. The input is from 90 to 250Vac.

AC Input Cord



WARNING: The AC input cord is a discrete device with the power supply. The input cord must be no longer than 9.84 feet (3m). Be sure the AC input cord is well connected according to Figure 1 and Figure 2 before operation.

The recommended AC input cord is specified in the table as follows. Add a non-locking plug or a breaker suitable for using in the country in which you are operating.

Power Supply	Wire Type		Rating	Cable Outside Diameter	Cable Gland (Strain Relief)
1 & 2 & 3 module	SJT	3 × 14 AWG stranded copper	60°C min. 300V	9.143~10.03m/m (0.360"~0.395")	KSS PG-2013
	H05	3G1.5mm.sq.	300/500V	8.5mm±0.2	
	VV-F	stranded copper			

- 1) Strip the outside insulation on the AC cable approximately 5cm to expose 3 wires.
- 2) Trim the wires to make the ground wire longer than another two wires and join the toric terminals to each stripped wires individually.
- 3) Unscrew the base of the strain relief from the helix-shaped body. Insert the base through the outside opening in the AC input cover and screw the locknut securely onto the base from the inside.
- 4) Insert the AC cable through the strain relief base until the outer cable jacket is adjoined with the edge of the base. Tighten the body to the base while holding the cable in place and the cable is fastened securely inside the strain relief.
- 5) Connect the toric terminals of the AC cable to the AC terminals in the rear panel adequately.

- 6) Screw the AC input cover to the AC terminal on the rear panel tightly.



WARNING: This is a bench type equipment, please use adequate AC cord set which is in compliance with the Electric Regulation of the country and well installation accordingly.

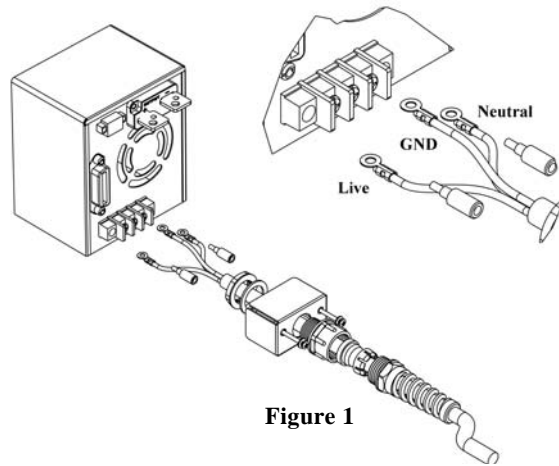

Figure 1

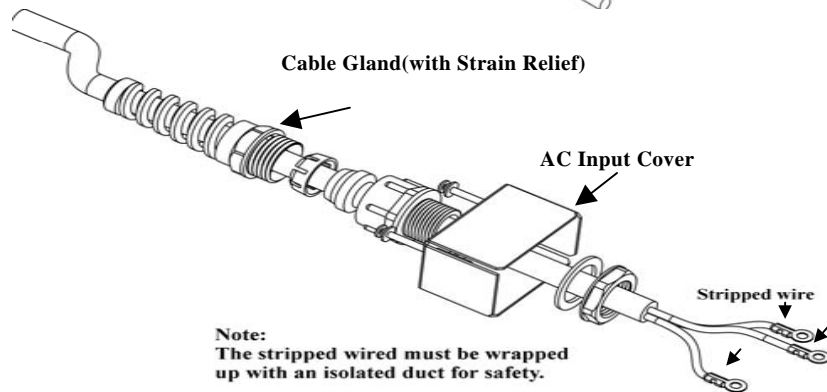
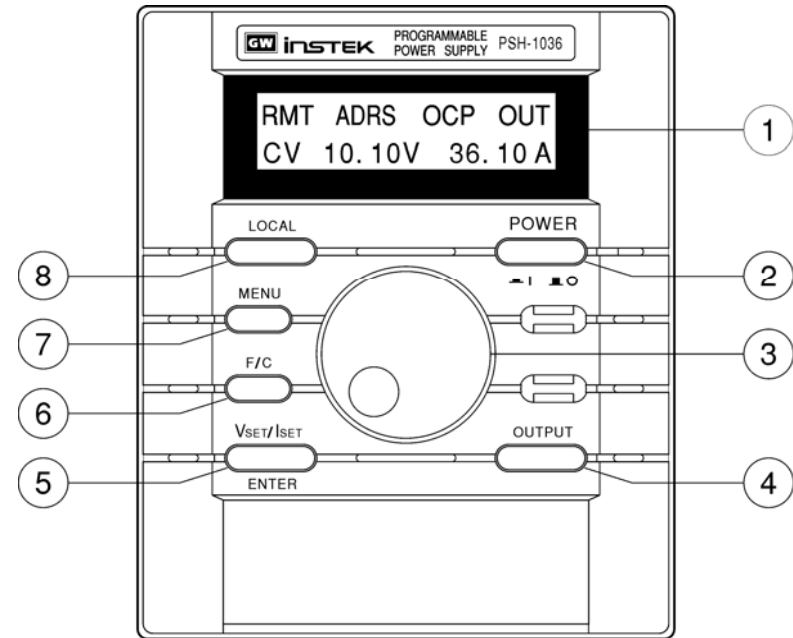
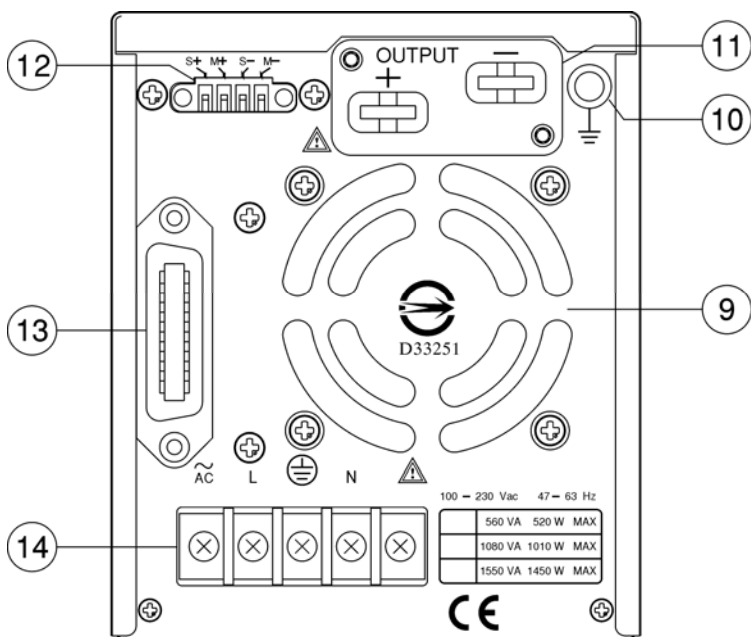

Figure 2

● **Front Panel**



● Rear Panel



5. OPERATION METHOD

The voltage and current unit applied for the instrument is Volt and Ampere.

5-1. Constant Voltage/Constant Current Crossover Characteristic

The working characteristic of this series is called a constant voltage/constant current automatic crossover type. This permits continuous transition from constant current to constant voltage modes in response to the load change. The intersection of constant voltage and constant current modes is called the crossover point. Fig.5-1 shows the relationship between this crossover point and the load.

For example, if the load is such that the power supply is operating in the constant voltage mode, a regulated output voltage is provided. The output voltage remains constant as the load increases, up until the point where the preset current limit is reached. At that point, the output current becomes constant and the output voltage drop is proportioned to further increases in load. The crossover point is indicated by the front panel LCD display. The crossover point is reached when the CV indicator transfer to CC indicator.

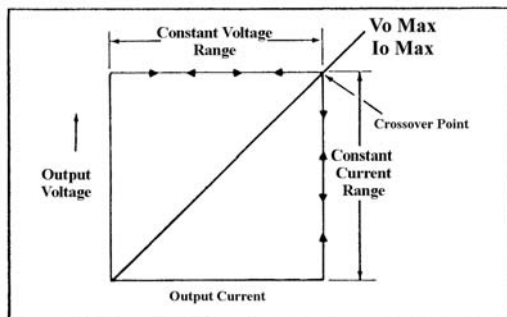

Figure 5-1 Constant Voltage/Constant Current Characteristic

Similarly, crossover from the constant current to the constant voltage mode automatically occurs from a decrease in load, a good example of this would be seen when charging a 12 volt battery. Initially, the open circuit voltage of the power supply may be preset for 13.8 volts. A low battery will place a heavy load on the supply and it will operate in the constant current mode, which may be adjusted for a 1 amp charging rate. As the battery becomes charged, and its voltage approaches 13.8 volts, its load decreases to the point where it no longer demands the full 1 amp charging rate. This is the crossover point where the power supply goes into the constant voltage mode.

5-2. Output Voltage/Current Setting

At first, set to voltage/current setting window or output value displayed window:

--Output Voltage Setting:

Switch the flashed cursor to voltage input position by pressing [Vset/Iset] key, and modify the setting value by using the wheel

knob. Now, use the [F/C] key to input the integral or dismal number.

Set 20.00V 18.00A

Example: Set voltage at 20.00V.

Switch the cursor to mV range by using the [F/C] key and adjust the value to number 00 with the rotation knob, then switch the cursor to V range by using the [F/C] key and adjust the value to number 20 with the rotation knob to complete the modification.

PS. At the moment, if the OUTPUT is on, the output voltage will be output the corresponding voltage value immediately following the adjustment of the rotation knob.

--Output Current Setting:

Switch the flashed cursor to current input position by pressing [Vset/Iset] key, and modify the setting value by using the wheel knob.

Now, use the [F/C] key to input the integral or dismal number.

Example: Set voltage at 18.00A.

Switch the cursor to mA range by using the [F/C] key and adjust the value to number 00 with the rotation knob, then switch the cursor to A range by using the [F/C] key and adjust the value to number 18 with the rotation knob to complete the modification.

PS. When the load current of output terminal exceeds the current setting value, the instrument is operated under the Constant Current mode (C.C. Mode), if it doesn't exceed the current setting value, the instrument is operated under the Constant Voltage mode (C.V. Mode).

If the maximum output voltage of the instrument is larger than 36V, the minimum adjustable step of the rotation knob is

20mV, if it is smaller than 36V, the minimum adjustable step of the rotation knob is 10mV.

5-3. Over Voltage /Current Protection Setting

--Over Voltage Protection Setting:

Set to OVP SET window by pressing [MENU], modify the OVP setting value with [F/C] key to input integral or dismal number, then press [ENTER].

--OVP Status Clear Up:

When the output voltage exceeds the setting voltage, the instrument will stop output and get into OVP mode by displaying “OVP Error. Press “LOCAL” to reset” messages on the panel.

Now press [LOCAL] to clear OVP status, back to previous status.

--Over Current Protection Setting:

Set to OCP SET window by pressing [MENU], then switch OCP to ON or OFF with the knob and press [ENTER]. When the OCP is on, the output current equals or exceeds the setting current, the instrument will stop output and get into OCP mode by displaying “OCP Error. Press “LOCAL” to reset” messages on the panel, Now press [LOCAL] to clear OCP status, back to previous status.

5-4. Display Contrast Setting:

Set to Contrast Setting window by pressing [MENU], modify the Contrast setting value with knob, then press [ENTER].

5-5. Buzzer Setting

Set to Buzzer Set window by pressing [MENU], switch Buzzer to ON or OFF with the knob, then press [ENTER].

5-6. GPIB/RS232 Interface Setting

Set to Interface window by pressing [MENU]. If the GPIB is displayed, the Address value window will be appeared, if the RS-232 is displayed, the Baud Rate window will be appeared, then using the

wheel knob to modify the value and press [ENTER] to complete the setting.

Note: The system will detect the interface used at present automatically, and switch the detected interface over the setting interface of GPIB or RS-232.

Example:

1) If want to set the GPIB address value to 08:

Set to interface window by pressing [MENU], and adjust the address value to 08 with the wheel knob and press [ENTER] to complete the setting.

2) If want to set the RS-232 Baud Rate to 9600:

Set to interface window by pressing [MENU], and adjust the Baud Rate value to 9600 with the wheel knob and press [ENTER] to complete the setting.

For further details, please refer to the programmer manual of PST/PSS/PSH series programmable power supply.

5-7. Remote Error Sensing

A normal power supply can perform its best load regulation, line regulation, low output impedance, and low output ripple and noise, as well as the rapidly transient recovery response. Please refer to figure 5-2. If there is any test lead connected between load and output terminal, the best characters of power supply can not be shown up on the load terminal.

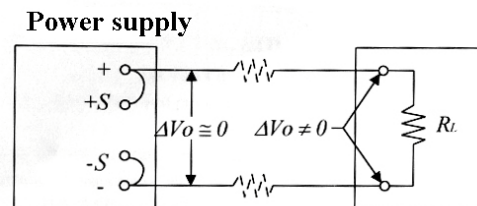

Figure 5-2 The power supply with local error sensing

The function of the Remote Error Sensing can only be applied to the Constant Voltage mode as shown in Figure 5-3. The feedback point of power supply must start from the load terminal directly. Therefore, the power supply can display its function on the load terminal instead of output terminal. To compensate the voltage drop causing from the test lead, it needs to shift the voltage from the output terminal of power supply, and the voltage on the load terminal remains unchanged.

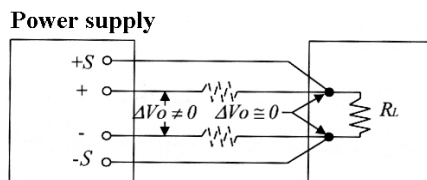

Figure 5-3 The power supply with remote error sensing

Error Sensing Open Protection

The sensing circuit must avoid open circuit without equipping with Relay, Switch, and Connector. When the open circuit is occurred abruptly on the sensing circuit, it will cause overshoot on the output terminal. To prevent this kind of phenomenon, add small resistance R1 and R2 or replace with diode as shown in the Figure 5-4.

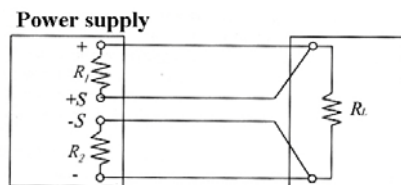

Figure 5-4 The power supply with remote error sensing protection

5-8. Test Lead Selective Table

When we use PSH-SER models power supply, the test lead must have an enough current capacity to prevent from damaged. The following is test lead selective table shows the maximum current rating, based on 450A/cm². A large test lead is recommended in order to reduce the voltage drop as less as better on the test lead (typical 0.5V maximum).

Wire Size (AWG)	Max. Current (A)	Wire Size (AWG)	Max. Current (A)
20	2.5	6	61
18	4	4	97
16	6	2	155
14	10	1	192
12	16	1/0	247
10	21	2/0	303
8	36		

6. MAINTENANCE

WARNING

The following instructions are executed by qualified personnel only. To avoid electrical shock, do not perform any servicing other than the operating instructions unless you are qualified to do so.



Warning: Do not remove covers. Refer servicing to qualified personnel.

AVERTISS: Ne pas enlever le capot. Seul un personnel habilité peut intervenir sur le matériel.



Warning: No operator serviceable components inside.

AVERTISS: Pas de maintenance sur les composants internes.



Warning: For continued fire protection. Replace fuse only with 250V fuse of the specific type and rating, and disconnect power cord before replacing fuse.

AVERTISS: Pour une protection contre les risques d'incendie, remplacer le fusible exclusivement par un modèle aux caractéristiques équivalentes.

6-1. ADJUSTMENT AND CALIBRATION

The instrument has been fully calibrated at factory before delivery. The readjustment is suggested only when the circuit of the instrument is modified, or the instrument is proved exceeding the specification by the sophisticated measured equipment. However, the accuracy of the calibrated multimeter must be within $\pm 0.1\%$ or better (GW model GDM-8145G or the equivalent equipment) and 1mV/AMP($\pm 0.25\%$) Current Shunt. Besides, the current rating of the

output load must be larger than the 10% of the output current at least.

--Preparation

- 1) 30 minutes warm up before calibration.
- 2) Ambient temperature: $23 \pm 5^\circ\text{C}$, Humidity: Under RH70%.
- 3) When the instrument is powered on but not yet output, use multimeter to measure TP301 AND TP302, adjust VR303 to ensure the difference of voltage between two parts is at $-10V_{DC}$, then measure TP303 and TP304, adjust VR302 to make TP303 larger than TP304 to be about $100mV_{DC}$. If the Unit 2 and Unit 3 are included to the equipment, measure TP501 and TP502, adjust VR501 to ensure the difference of voltage between two points is $-10V_{DC}$, and the TP504 among the Unit 2 and Unit 3 must be larger than TP503 to be about $40mV_{DC}$.

--Output Calibration Steps:

[Step 1]

Repress [LOCAL] for 4~5 seconds, the window will appear "Please enter the password" (vary with different models: PSH-1036: 1036, PSH-6006: 6006), now input the value number with the knob and use [F/C] key to move key-in position, then press [ENTER] key. When the value number is input by mistake, the system will jump out this mode.

[Step 2] Voltage Calibration Steps

At first, set the DMM to 200V voltage range.

[Step 2.1]

Get into the window of Calibration item, select the item of Voltage calibration with knob and press [ENTER].

[Step 2.2]

Input measured voltage value (Min) with the knob and press [ENTER]. During the value input, use [F/C] key to switch over the integral or dismal number input.

[Step 2.3]

Now, adjust VR301 properly for the measured voltage (Max) of DMM according to the value displayed in the window, then press [ENTER].

Note: During the adjustment, the maximum distortion range of the measured value is at 0.005V.

[Step 3] Current Calibration Steps

At first, make sure the output is disconnected with test leads, if the specification of current is smaller than 20A, can either use 20A range of GDM-8145G or connect current shunt to output terminal to measure the output current. If the specification of current is larger than 20A, must connect current shunt to output terminal to measure both ends of the current shunt with 200mV range of DMM.

[Step 3.1]

Get into the window of Calibration item, select the item of current calibration with knob and press [ENTER] to start Current Calibration Steps.

[Step 3.2]

Input measured voltage value (Max) with the knob and press

[ENTER]. During the value input, use [F/C] key to switch over the integral or dismal number input.

[Step 3.3]

Input measured voltage value (Min) with the knob and press [ENTER]. During the value input, use [F/C] key to switch over the integral or dismal number input.

[Step 4]

Unplug the test lead, switch to the window of OVP calibration item with the knob, press [ENTER] to start automatically OVP calibration item

[Step 4.1]

Now, the window will display the calibration progress. After the calibration is finished, the system will jump out the window.

[Step 5]

After make sure all the calibration procedure is completed and correct, switch the window to Save and press [ENTER] key to finish the calibration procedure.

[Step 6]

If it is not necessary to store the calibration data, just switch to EXIT with the knob and press [ENTER] to leave the calibration window.

6-2. Cleaning

To clean the power supply, use a soft cloth dampened in a solution of mild detergent and water. Do not spray cleaner directly onto the instrument, since it may leak into the cabinet and cause damage. Do not use chemicals containing benzene, benzene, toluene, xylene, acetone, or similar solvents. Do not use abrasive cleaners on any portion of the instrument.

7. THE SYSTEM DIAGRAM AND DESCRIPTION

7-1. Block Diagram

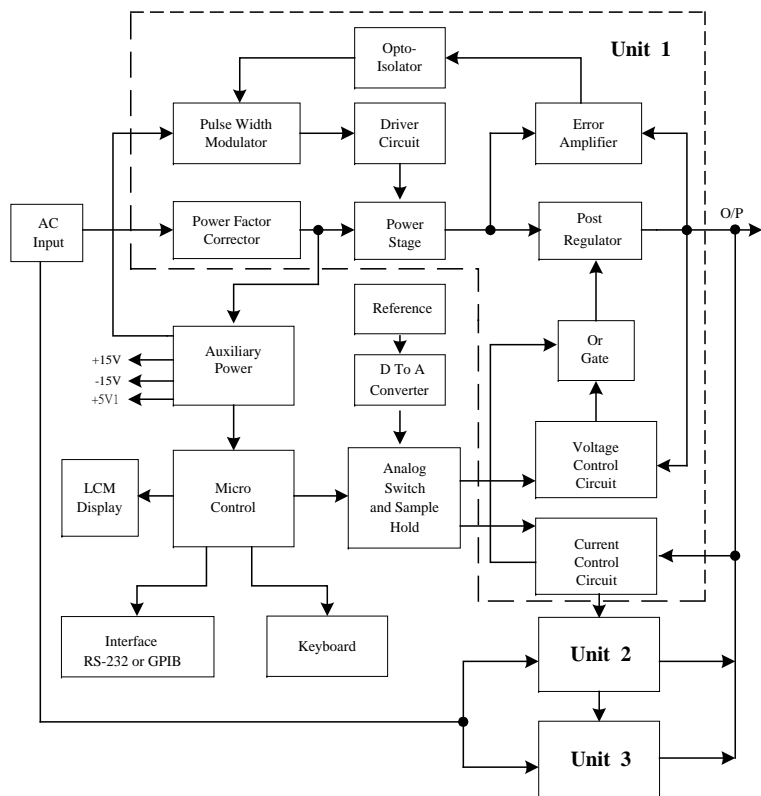

7-2. The Configuration of PSH-series Block System

The whole Block system consists of the following Circuit Blocks:

Power Factor Corrector: BD101, Q101-Q103, D102.

Micro Processor Unit (MPU): U308

Digital to Analog Converter (DAC): U316.

Analog Switch Circuit: U328, R356, R363, R370, C314, C318, C320, U331.

Pulse Width Modulation: U206.

Driver Circuit: Q202-Q203, T202.

Power Stage: Q204-Q205, Q211-Q212, T203, D207-D208, L201, C246-C249, C253.

Post Regulator: Q207, Q208.

Voltage Control Circuit: U334.

Current Control Circuit: U334.

Error Amplifier: U333.

Opto-isolator: U209.

Auxiliary Power supply: Q201, U203, T201.

OVP: U315, U331, Q209, U327, Q310, U328.

Unit 2: When the power reaches about 2 times the Unit 1, the Unit 2 will be used additionally.

Unit 3: When the power reaches about 3 times the Unit 1, the Unit 2 and Unit 3 will be used additionally.

APPENDIX:





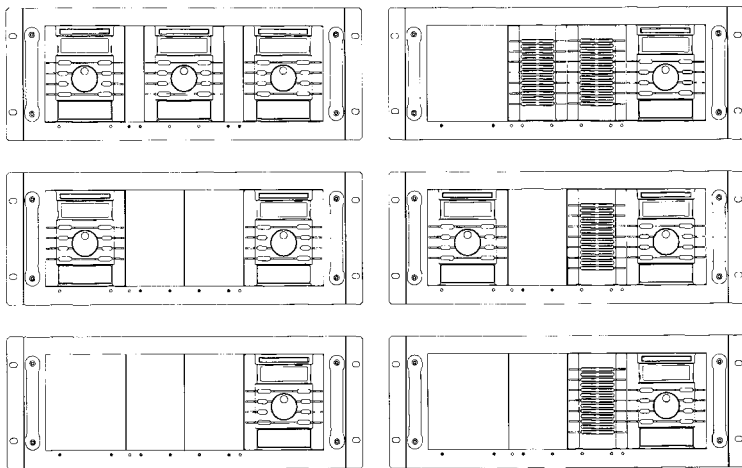

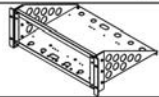

RACK-MOUNTING

To meet the demand of the Auto-test or Aging-test operation, the power supply can be mounted in a standard 19-inches rack cabinet using one of our GRA-403 optional kits available for selection. The drawing is shown as below:



The detailed information about the rack-mounting, please refer to the operation manual of GRA-403.

COMPONENT LIST OF RACK-MOUNTING:

NO.	Item	Drawing	Qty
①	Main Bracket		1
②	Front Panel		1
③	Large Decoration Board		1
④	Medium Decoration Board		2
⑤	Small Decoration Board		2
⑥	Binding plate		6
⑦	Handle		2
⑧	Screw M4*0.7 L=10mm		4
⑨	Screw M3*0.5 L=8mm		18

THE ASSEMBLED STEPS OF RACK-MOUNTING:**Step 1:**

Lock up the front panel with the adequate decoration board according to different model of power supplies

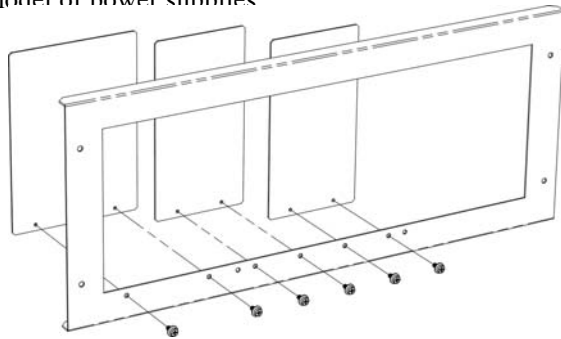
**Step 2:**

Remove the front and back M3 screws from both sides of power supplies. Fix the binding plate to the both sides of power supply by using the previous removed M3 screws.

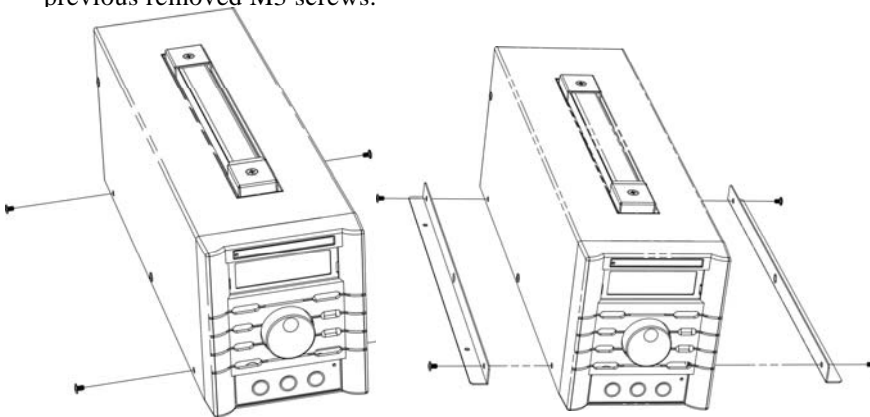
**Step 3:**

Put the assembled power supply to the main bracket according to the alignment of rack cabinet, then fix it to the main bracket with No. 9 screws described on the component list.

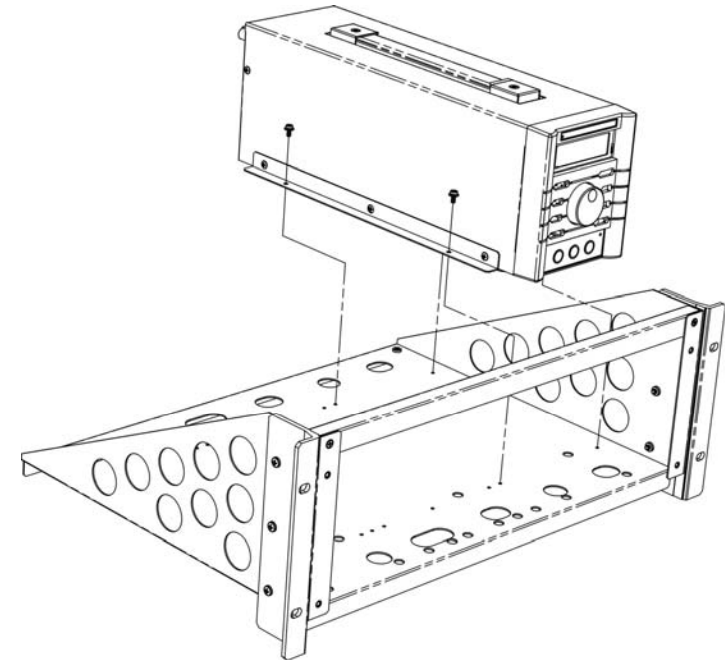

Step 4:

Across the handle with No. 8 screw described on the component list to fix the assembled front panel (Step 2) to the main bracket.

