



RF DIRECTIONAL
THRULINE® WATTMETER
MODEL APM-16

OPERATION MANUAL

©COPYRIGHT 2016 BY BIRD TECHNOLOGIES, INC.
INSTRUCTION BOOK PART NUMBER 920-APM16 REV. E

THRULINE® AND TERMLINE® ARE REGISTERED TRADEMARKS
OF BIRD ELECTRONIC CORPORATION

Safety Precautions

The following are general safety precautions that are not necessarily related to any specific part or procedure, and do not necessarily appear elsewhere in this publication. These precautions must be thoroughly understood and apply to all phases of operation and maintenance.

WARNING

Keep Away From Live Circuits

Operating Personnel must at all times observe general safety precautions. Do not replace components or make adjustments to the inside of the test equipment with the high voltage supply turned on. To avoid casualties, always remove power.

WARNING

Shock Hazard

Do not attempt to remove the RF transmission line while RF power is present.

WARNING

Do Not Service Or Adjust Alone

Under no circumstances should any person reach into an enclosure for the purpose of service or adjustment of equipment except in the presence of someone who is capable of rendering aid.

WARNING

Safety Earth Ground

An uninterruptible earth safety ground must be supplied from the main power source to test instruments. Grounding one conductor of a two conductor power cable is not sufficient protection. Serious injury or death can occur if this grounding is not properly supplied.

WARNING

Resuscitation

Personnel working with or near high voltages should be familiar with modern methods of resuscitation.

WARNING

Remove Power

Observe general safety precautions. Do not open the instrument with the power on.

Safety Symbols

WARNING

Warning notes call attention to a procedure, which if not correctly performed, could result in personal injury.

CAUTION

Caution notes call attention to a procedure, which if not correctly performed, could result in damage to the instrument.



The caution symbol appears on the equipment indicating there is important information in the instruction manual regarding that particular area

Note: *Calls attention to supplemental information.*

Warning Statements

The following warnings appear in the text where there is danger to operating and maintenance personnel, and are repeated here for emphasis.

WARNING

Never attempt to connect or disconnect RF equipment from the transmission line while RF power is being applied. Leaking RF energy is a potential health hazard.

Refer to page 11.

WARNING

RF voltage may be present in element socket. Keep element in socket during operation.

Refer to pages 11 and 13.

Caution Statements

The following equipment cautions appear in the text and are repeated here for emphasis.

CAUTION

For low reflection measurements, do not rotate the reflected power element to read forward power. Damage to the element or wattmeter could result.

Refer to page 7.

CAUTION

To prevent damage from battery leakage, remove the battery if the unit will not be used for more than two weeks.

Refer to pages 11 and 23.

CAUTION

Do not attempt to remove the RF center conductor. This will damage the line section.

Refer to page 19.

Safety Statements

USAGE

ANY USE OF THIS INSTRUMENT IN A MANNER NOT SPECIFIED BY THE MANUFACTURER MAY IMPAIR THE INSTRUMENT'S SAFETY PROTECTION.

USO

EL USO DE ESTE INSTRUMENTO DE MANERA NO ESPECIFICADA POR EL FABRICANTE, PUEDE ANULAR LA PROTECCIÓN DE SEGURIDAD DEL INSTRUMENTO.

BENUTZUNG

WIRD DAS GERÄT AUF ANDERE WEISE VERWENDET ALS VOM HERSTELLER BESCHRIEBEN, KANN DIE GERÄTESICHERHEIT BEEINTRÄCHTIGT WERDEN.

UTILISATION

TOUTE UTILISATION DE CET INSTRUMENT QUI N'EST PAS EXPLICITEMENT PRÉVUE PAR LE FABRICANT PEUT ENDOMMAGER LE DISPOSITIF DE PROTECTION DE L'INSTRUMENT.

IMPIEGO

QUALORA QUESTO STRUMENTO VENISSE UTILIZZATO IN MODO DIVERSO DA COME SPECIFICATO DAL PRODUTTORE LA PROZIONE DI SICUREZZA POTREBBE VENIRNE COMPROMESSA.

SERVICE

SERVICING INSTRUCTIONS ARE FOR USE BY SERVICE - TRAINED PERSONNEL ONLY. TO AVOID DANGEROUS ELECTRIC SHOCK, DO NOT PERFORM ANY SERVICING UNLESS QUALIFIED TO DO SO.

SERVICIO

LAS INSTRUCCIONES DE SERVICIO SON PARA USO EXCLUSIVO DEL PERSONAL DE SERVICIO CAPACITADO. PARA EVITAR EL PELIGRO DE DESCARGAS ELÉCTRICAS, NO REALICE NINGÚN SERVICIO A MENOS QUE ESTÉ CAPACITADO PARA HACERLO.

WARTUNG

ANWEISUNGEN FÜR DIE WARTUNG DES GERÄTES GELTEN NUR FÜR GESCHULTES FACHPERSONAL.

ZUR VERMEIDUNG GEFÄHRLICHE, ELEKTRISCHE SCHOCKS, SIND WARTUNGSARBEITEN AUSSCHLIEßLICH VON QUALIFIZIERTEM SERVICEPERSONAL DURCHZUFÜHREN.

ENTRETIEN

L'EMPLOI DES INSTRUCTIONS D'ENTRETIEN DOIT ÊTRE RÉSERVÉ AU PERSONNEL FORMÉ AUX OPÉRATIONS D'ENTRETIEN. POUR PRÉVENIR UN CHOC ÉLECTRIQUE DANGEREUX, NE PAS EFFECTUER D'ENTRETIEN SI L'ON N'A PAS ÉTÉ QUALIFIÉ POUR CE FAIRE.

ASSISTENZA TECNICA

LE ISTRUZIONI RELATIVE ALL'ASSISTENZA SONO PREVISTE ESCLUSIVAMENTE PER IL PERSONALE OPPORTUNAMENTE ADDESTRATO. PER EVITARE PERICOLOSE SCOSSE ELETTRICHE NON EFFETTUARE ALCUNA RIPARAZIONE A MENO CHE QUALIFICATI A FARLA.

RF VOLTAGE MAY BE PRESENT IN RF ELEMENT SOCKET - KEEP ELEMENT IN SOCKET DURING OPERATION.

DE LA TENSION H.F. PEAT ÊTRE PRÉSENTE DANS LA PRISE DE L'ÉLÉMENT H.F. - CONSERVER L'ÉLÉMENT DANS LA PRISE LORS DE L'EMPLOI.

HF-SPANNUNG KANN IN DER HF-ELEMENT-BUCHSE ANSTEHEN - ELEMENT WÄHREND DES BETRIEBS EINGESTÖPSELT LASSEN.

PUEDE HABER VOLTAJE RF EN EL ENCHUFE DEL ELEMENTO RF - MANTENGA EL ELEMENTO EN EL ENCHUFE DURANTE LA OPERACION.

IL PORTAELEMENTO RF PUÒ PRESENTARE VOLTAGGIO RF - TENERE L'ELEMENTO NELLA PRESA DURANTE IL FUNZIONAMENTO.

About This Manual

This manual covers the operating and maintenance instructions for the following models:

APM-16

Changes to this Manual

We have made every effort to ensure this manual is accurate. If you discover any errors, or if you have suggestions for improving this manual, please send your comments to our Solon, Ohio factory. This manual may be periodically updated. When inquiring about updates to this manual refer to the part number and revision on the title page.

Literature Contents

Chapter Layout

Introduction — Describes the features of the Bird APM-16.

Theory of Operation — Describes how the APM-16 operates and describes measurement methodologies.

Installation — Describes battery care, connecting elements to the APM-16, and system connections.

Operation — Describes the process for measuring forward and reflected power, includes charts for calculating VSWR, and provides information on load matching.

Maintenance — Lists routine maintenance, repair, calibration and troubleshooting procedures for common problems. This section also includes APM-16 specifications, parts information, and Bird Service Center contact information.

TABLE OF CONTENTS

Safety Precautions	i
Safety Symbols	ii
Warning Statements	ii
Caution Statements	iii
Safety Statements	iv
About This Manual	vii
Changes to this Manual	vii
Literature Contents	vii
Chapter Layout	vii
Chapter 1 Introduction	1
Description	1
Chapter 2 Theory of Operation.	2
Traveling Wave Viewpoint	2
Coupling Circuit	2
Load Power	3
Standing vs. traveling Waves	3
ρ vs. ϕ	4
Low Reflection	7
Transmitter Monitoring	7
Component Testing	7
Frequency Response	9
Impedance Mismatch	10
Chapter 3 Installation	11
Battery	11
Elements	11
Connecting RF Power	12
Absorption Wattmeter	12
Chapter 4 Operating Instructions	13
Normal Operation	13
Load Matching	16
Chapter 5 Maintenance	18
Troubleshooting	18
Maintenance Procedures	19
Cleaning	19

Contact Adjustment 19

Battery 19

Zero Adjust 19

Repair 20

 “QC” Connectors 20

 Replacing the Meter 20

 Replacing the Instrumentation Module 20

Calibration 21

 Calibration Environment 21

 Equipment Required 21

 Calibrating 22

Storage 23

Customer Service 23

Specifications 24

Replacement Parts List 25

Available “QC” Type Connectors 26

Limited Warranty 27

The Bird APM-16 is an insertion wattmeter designed to measure RF power and load match in 50 ohm transmission lines. It has a maximum VSWR of 1.05 for frequencies up to 1000 MHz. The meter provides direct readings in watts with an expanded linear scale for easy reading. The scale is graduated for 25, 50, and 100 full scale. Elements are available in a variety of power and frequency ranges (See the Bird Electronic Corporation Catalog for details).

Description

The Bird APM-16 is portable and rugged, with an aluminum housing. For additional protection, the microammeter is specially shock mounted. Bumpers on the base and back allow the meter to stand or lie flat. Refer to [Figure 1](#) to identify components.

At each end of the line section are Bird Quick-Change RF connectors that may be interchanged with any other Bird "QC" connector. The wattmeter housing does not interfere with connector changes.

Figure 1 Outline Drawing

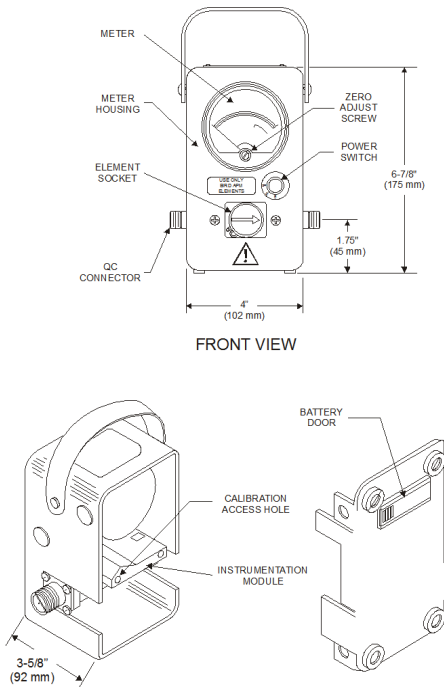

Traveling Wave Viewpoint

The easiest way to visualize Thru-line operation is from a traveling wave viewpoint. In transmission lines the voltages, currents, standing waves, etc., on any uniform line section result from the interaction of two traveling waves:

- The forward wave (and its power) travels from the source to the load. It has RF voltage E_f and current I_f in phase, with $E_f / I_f = Z_0$.
- The reflected wave (and its power) originates by reflection at the load and travels from the load back to the source. It has an RF voltage E_r and current I_r in phase, with $E_r / I_r = Z_0$.

Each wave is mathematically simple and has a constant power:

$$W_f = \text{Watts Forward} = E_f^2 / Z_0 = I_f^2 Z_0 = E_f I_f$$

$$W_r = \text{Watts Reflected} = E_r^2 / Z_0 = I_r^2 Z_0 = E_r I_r$$

Z_0 is the characteristic impedance of a uniform line section. For useful lines it is usually a pure resistance of 50 ohms. The RF circuit of the Bird APM-16 is a length of uniform air line with $Z_0 = 50$ ohms.

Coupling Circuit

The Bird Plug-In Element contains a coupling circuit that samples the traveling waves. The element circuitry and its relationship to the rest of the Bird APM-16 are illustrated in [Figure 5](#).

Figure 2 Schematic

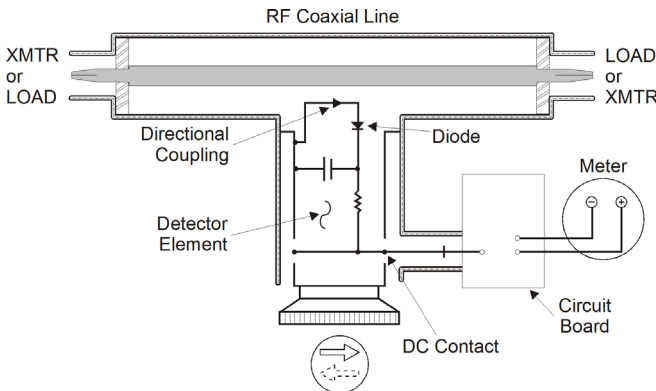

Current is produced in the coupling circuit by the traveling waves in the line section. Both inductive and capacitive coupling contribute to this. Inductive current flows in the direction of the traveling wave, while the capacitive current is independent of the direction of the traveling wave. Therefore, the inductive current produced by one traveling wave will add in phase with the corresponding capacitive current, while that produced by the wave traveling in the opposite direction will subtract. The additive or “arrow” direction is assigned to the forward wave.

The electrical characteristics of the element are carefully adjusted so that, for the reverse traveling wave, the inductive current will completely cancel the capacitive current. The result is directivity greater than 25 dB. Thus, the element is sensitive at either of its settings, but to only one of the two traveling waves. Thru-line Wattmeter measurements are also independent of position along the transmission line.

Like similar diode devices, the Bird APM-16 indicates the carrier component of amplitude modulation, with very little response to side band components added by modulation.

Load Power

For loads with a VSWR of 1.2 or less, the power dissipated in a load (W_l) is equal (with less than one percent error) to the forward power (W_f). When appreciable power is reflected, as with an antenna, it is necessary to use the exact load power, given by:

$$W_l = \text{Watts into Load} = W_f - W_r$$

Good load resistors, such as Bird Termline Loads, will give negligible reflected power.

Standing vs. traveling Waves

As mentioned previously, the Thru-line Wattmeter reacts to forward and reverse traveling waves to measure power in a transmission line. The standing wave viewpoint, also widely used, is highly developed both in theory and in practice. This viewpoint can be traced to the early use of slotted transmission lines.

The slotted line measures the standing wave ratio by mechanically positioning a voltage detector at peaks and nulls along a length of line section. Its drawbacks are that it is usually too long, too expensive for good accuracy, not portable, and too slow. These problems grow rapidly as the measurement frequency drops below 1000 MHz. The Thru-line Wattmeter by comparison is fast, convenient, and accurate. It provides the same information as a slotted line except for the phase angle of the reflection coefficient (distance, load to minimum).

ρ VS. ϕ

The simple relationships:

$$\rho = \frac{1 + \sqrt{\phi}}{1 - \sqrt{\phi}} \text{ and } \phi = \left[\frac{\rho - 1}{\rho + 1} \right]^2 \quad \text{Where } \rho = \text{VSWR}$$

$\text{and } \phi = W_r / W_f$

can be used to convert between the standing wave ratio (ρ) and the reflected/forward power ratio (ϕ), which can be directly read from the Thruline Wattmeter. The relationship between ρ and ϕ is graphed in [Figure 3](#) and [Figure 4](#).

Note: Attenuation, measured in dB, can be derived from the power ratio by the equation

$$N_{\text{db}} = 10 \log \phi.$$

VSWR scales and their attendant controls for setting the reference point have been intentionally omitted from the Bird APM-16. Experience using the Thruline Wattmeter for transmitter tune-up, antenna matching, etc. will show that the power ratio measurement is as useful as the standing wave ratio.

A trial is suggested – forget about VSWR for a few days and think in terms of $\phi = W_r / W_f$. The meter readings, W_r and W_f , give a useful, approximate picture of the results without bothering to calculate the power ratio exactly. Consider that, for an antenna matching problem, the main objective usually is to minimize W_r . Anything done experimentally to this end will be seen when the element is in the reflected power position.

Figure 3 Percent Reflected Power vs. VSWR (1.0 – 8.0)

$$\phi = \frac{W_r}{W_f} \times 100 = \frac{\text{REFLECTED POWER}}{\text{FORWARD POWER}} \times 100$$

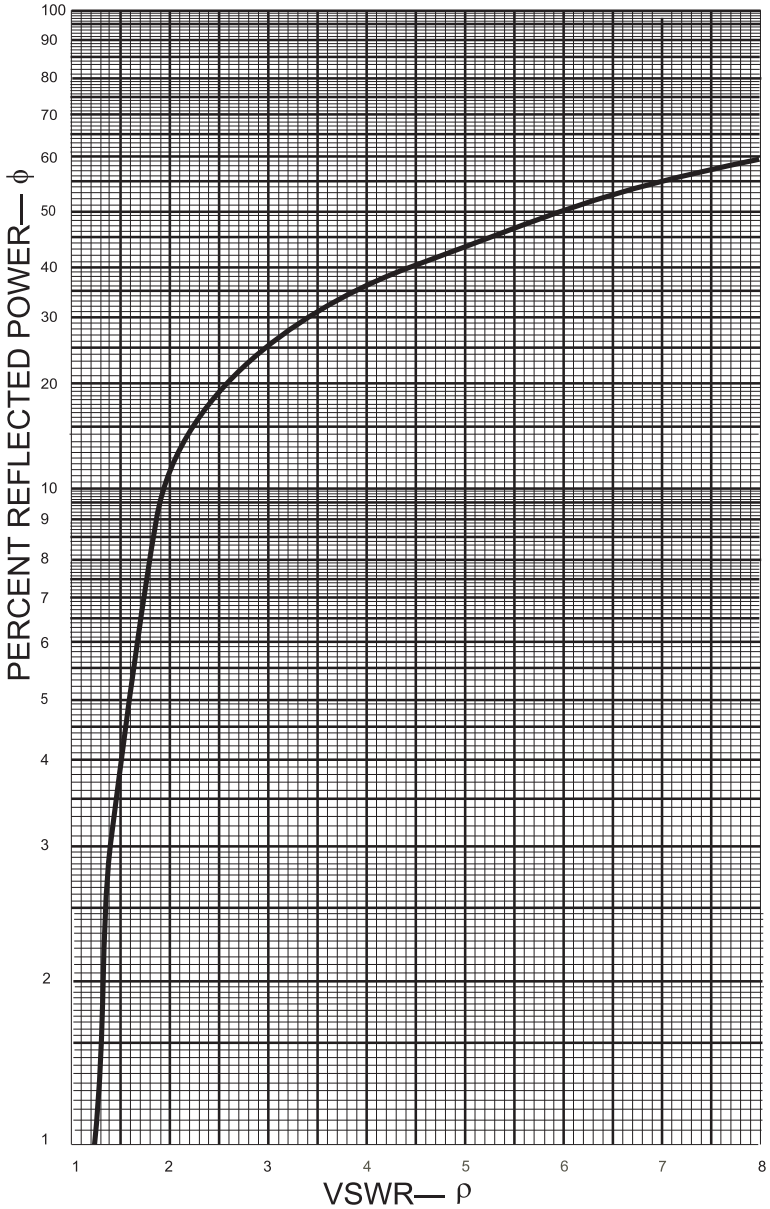
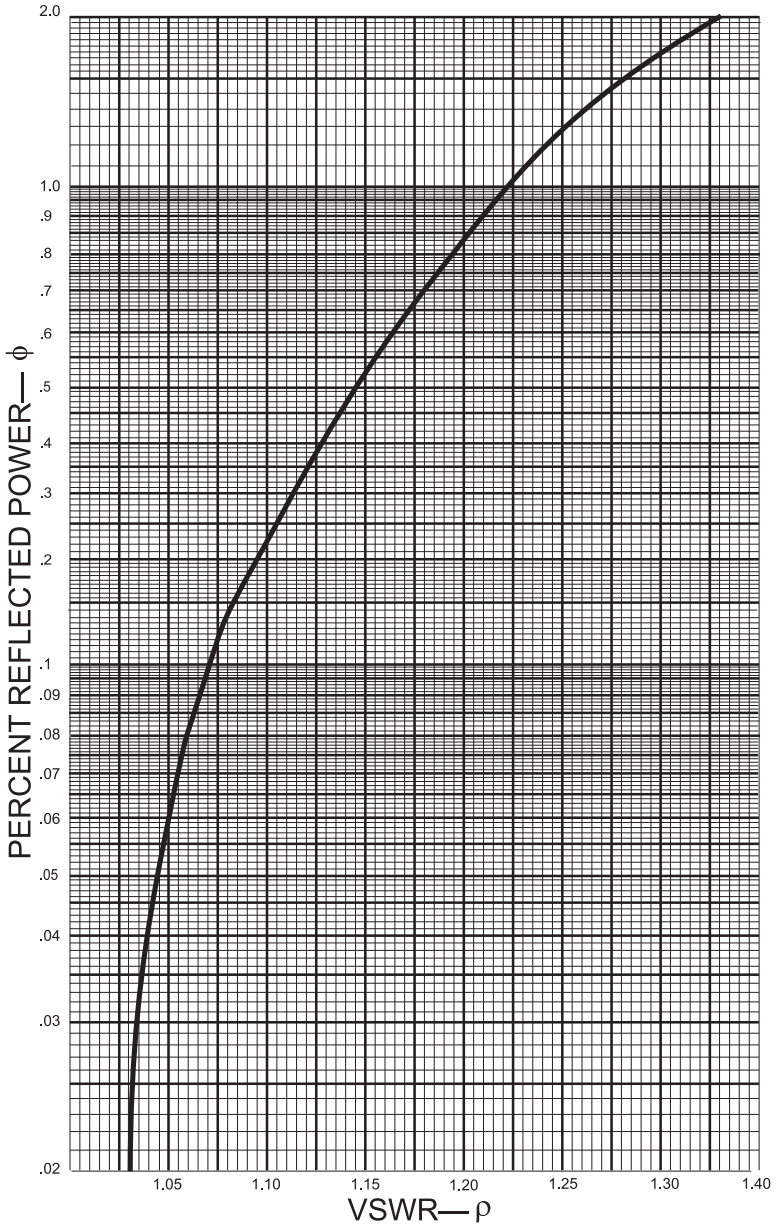

Figure 4 Percent Reflected Power vs. VSWR (1.0 – 1.3)

$$\phi = \frac{W_r}{W_f} \times 100 = \frac{\text{REFLECTED POWER}}{\text{FORWARD POWER}} \times 100$$



Low Reflection

$\phi = 10\%$ ($\rho = 2$) is the typical limit of antenna match. Further effort is frequently not worthwhile because below this level reflected power is hard to measure, and W_f can not be significantly increased. TV and VHF transmitters are examples of systems requiring lower reflected power but for reasons other than maximizing power transmission.

CAUTION

For low reflection measurements, do not rotate the reflected power element to read forward power. Damage to the element or wattmeter could result.

When the same element is used to measure both forward and reflected power, meaningful readings are possible down to about $\phi = 5\%$ ($\rho = 1.5$). For accurate measurement of very low levels of reflected power, i.e. $\phi = 0.6\%$ ($\rho = 1.17$), use a second element rated at one tenth of the full scale power of the forward element. This method should not be used with element ranges differing by more than 10:1.

For example, consider an 80 watt transmitter and a Bird APM-16 with 100 and 10 watt elements. Measure W_f with the 100 W element. Measure W_r with the 10 W element (make sure the arrow points towards the transmitter). W_r can be measured down to at least 0.5 W, so that $\phi = 0.5 / 80$ or about 0.6%, corresponding to $\rho = 1.17$.

Transmitter Monitoring

The Thruline Wattmeter can be used for continuous monitoring of transmitter output or reflected power, for instance while checking intermittent antenna or line faults.

Component Testing

The Bird APM-16 is very helpful in component testing, and may be employed in several ways:

1. Insertion VSWR or ϕ can be measured by placing the component between the wattmeter and a good load resistor.
2. Attenuation (power lost by heat in a line) as well as insertion VSWR or ϕ can be measured by inserting the unknown line between two Thruline Wattmeters, or between a Thruline Wattmeter and a Termaline Absorption Wattmeter.

Note: *Very small attenuations require allowance for normal instrument errors. To correct for this without any calculations, connect the wattmeters directly, with no line between them, and adjust their zero settings.*

3. Line loss using open circuit calibration: The high directivity of elements can be exploited in line loss measurements, because of the equality of forward and reflected power with the load connector open or short circuited. In this state the forward and reflected waves have equal power, so that $f = 100\%$ and $r = \infty$. Open circuit testing is preferred to short circuit, because a high quality open circuit is easier to create than a high quality short. To measure insertion loss, use a high quality open circuit to check forward and reverse power equality, then connect an open-circuited, unknown line to the wattmeter. The measured f is the attenuation for two passes along the line (down and back). The attenuation can then be compared with published data for line type and length (remember to halve Ndb or double the line length to account for the measurement technique).

This measurement should be supplemented by either time domain reflectometry or DC continuity and leakage checks, since the attenuation measurement alone cannot account for faults such as open or short circuits partway down the line.

Note: *Very small attenuations require allowance for normal instrument errors. Make sure to note exact readings, or their difference, on the initial equality check, and correct for this.*

Frequency Response

Bird Plug-In Elements have a flat frequency response over their specified operating range. A sample set of curves is shown in [Figure 5](#). Notice that for the low power element, the rolloff outside its frequency band is more pronounced than for the high power elements. For example, at 40 MHz the 10C element will have a loss of 4 dB, giving a reading of about 40% of the true value. For the 100C, the loss will only be about 1 dB, for a reading at 80% of the true value, and the 500C should be within the normal 5% of full scale tolerance.

Figure 5 Representative Frequency Response

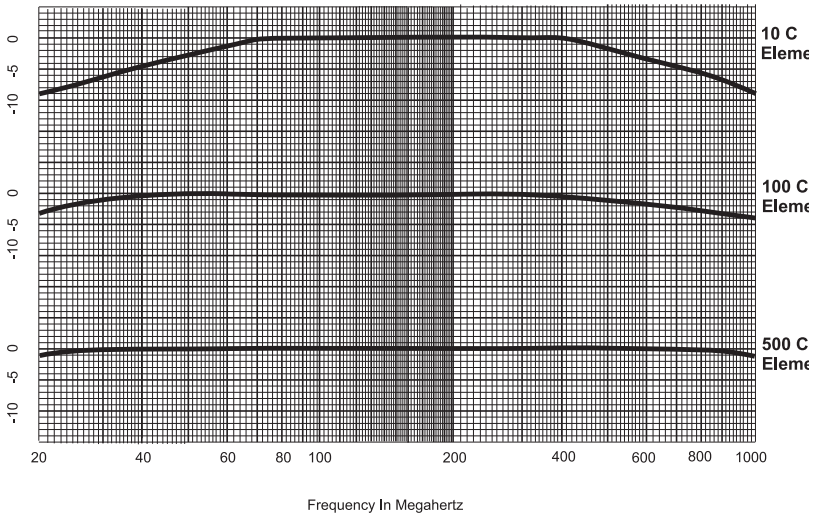

These curves are typical for all element types (H, A, B, C, D, ...) at their respective frequencies. Since C elements have a frequency range of 100 - 250 MHz, response curves for other element types can be approximated by replacing the 100 and 250 MHz points on the chart with the extremes of the element's frequency range, and recalculating the other frequency points accordingly. For example, for a B element (range 50 - 125 MHz) simply divide all frequencies by two. For an E element (range 400 - 1000 MHz) multiply all frequencies by four.

Harmonics or subharmonics that lie outside of the frequency range of the element may exist in the circuit under test. A rough approximation of the element's response to harmonics can be made with these curves. Using an element for measurements outside of its frequency range is not recommended. The response curves presented are only typical, and not guaranteed.

Impedance Mismatch

There may be cases where it is necessary to use the Bird APM-16 with a non-50 ohm transmission line. If the reflected power is less than 10% and the frequency is below 200 MHz, the resulting mismatch will not be too serious. At higher frequencies or higher reflected power levels, the load impedance will change when the wattmeter is removed from the circuit.

When the line and load impedances are known, the system's VSWR can be calculated by dividing the larger impedance by the smaller. Remember that the VSWR ratio must always be greater than 1.

For example, consider using a Bird APM-16 to tune a 70 ohm line. If the load impedance is also 70 ohms, the wattmeter will measure a VSWR of $70/50 = 1.4$. However, if you remove the wattmeter, the VSWR will actually be 1.0. If the load impedance is 35.7 ohms instead, the VSWR will be $50/35.7 = 1.4$ with the wattmeter and $70/35.7 = 2.0$ without it. Caution must therefore be used, since both good and bad matches can have the same measured VSWR. In this case, the correct impedance can be determined by slightly changing the load impedance. When the load impedance is near 70 ohms, the Bird 43 will read increasing VSWR as the load impedance is increased.

Note: *When working with non-50 ohm lines, it is especially important to calculate the load power by subtracting the reflected power from the forward power.*

CAUTION

To prevent damage from battery leakage, remove the battery if the unit will not be used for more than two weeks.

WARNING

Never attempt to connect or disconnect RF equipment from the transmission line while RF power is being applied. Leaking RF energy is a potential health hazard.

Battery

The 9 V battery must be installed before operation. [Figure 1 on page 1](#) shows the location of the battery access door. Slide this open and connect the battery.

When transporting or storing the Bird APM-16, be sure the power switch is set to OFF. In any other position, there is a slight drain on the battery.

WARNING

RF voltage may be present in element socket. Keep element in socket during operation.

Elements

The Bird APM-16 uses Bird Plug-In Elements to make measurements. The element's frequency range and maximum power are listed on its label. The transmitter test frequency should be within the band of the element used. The arrow on the element points in the direction of power flow that the meter will read.

To make measurements, insert an element into the line section socket and rotate it against one of the stops. Contacts on opposite sides of the element connect with a spring finger in the socket when the element is in the forward or reverse position. A small catch at the corner of the socket face presses on the shoulder of the element to keep it in proper alignment (see [Figure 6](#)).

Figure 6 Securing an element

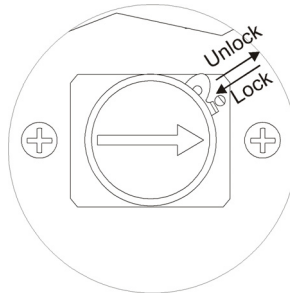

Connecting RF Power

Insert the Bird APM-16 in 50 ohm coaxial transmission lines. The RF source can be connected to either side of the wattmeter.

Absorption Wattmeter

Combining the Thruline Wattmeter with a Bird Termaline Load creates an accurate absorption wattmeter. With this combination, readings only need to be taken in the forward direction because the reflected power will be negligible.

WARNING

RF voltage may be present in element socket. Keep element in socket during operation.

Normal Operation

1. Insert the element in the line section socket.
2. To measure forward power, turn the element so that the arrow points towards the load.
3. To measure reflected power, turn the element so that the arrow points towards the source.
4. Turn on the RF source.
5. Read the power using the scale whose full-scale marking matches the element's maximum power.

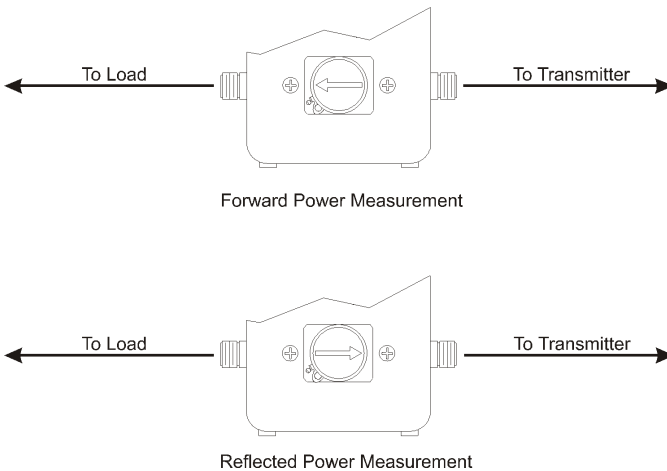
Figure 7 Element Direction

For your convenience, a pair of VSWR conversion graphs are included in this manual. With these charts, VSWR can be determined from the forward and reflected power. Find the intersection of the forward and reflected power measurements. The slanted line passing closest to this point is the VSWR.

Figure 8 VSWR Conversion Graph (Reflected Power 0.2 – 20.0)

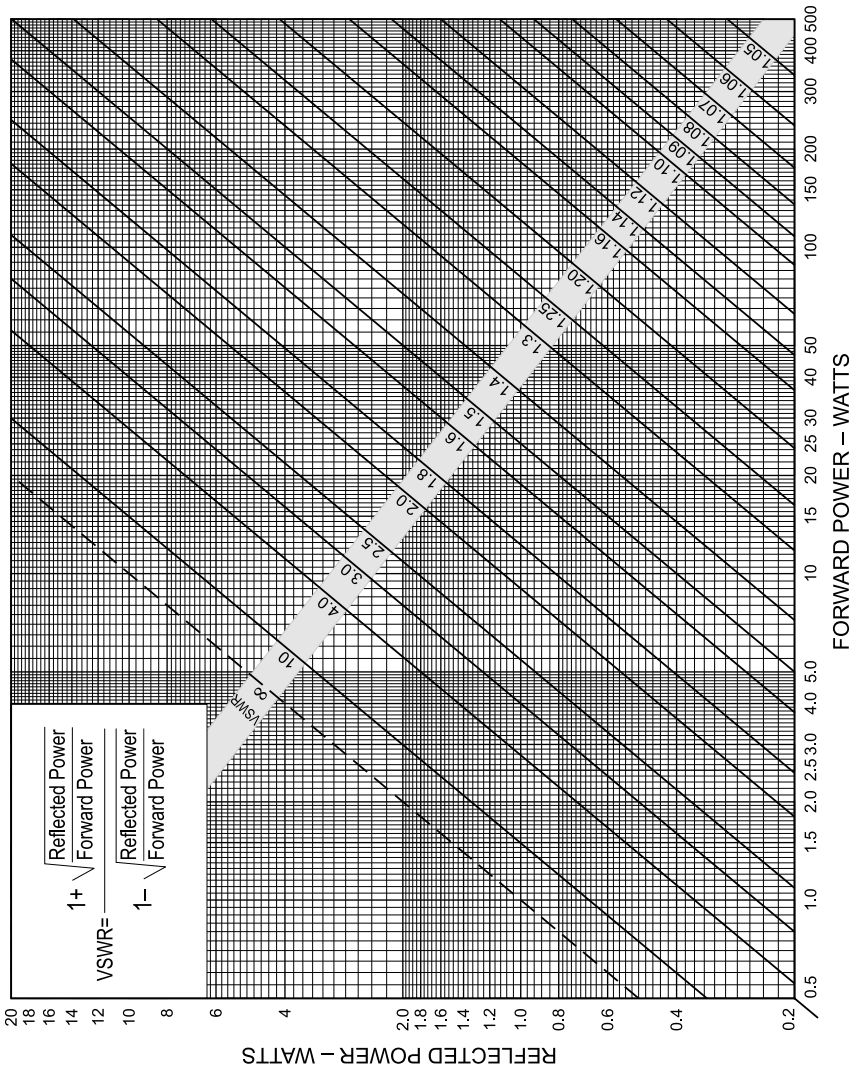
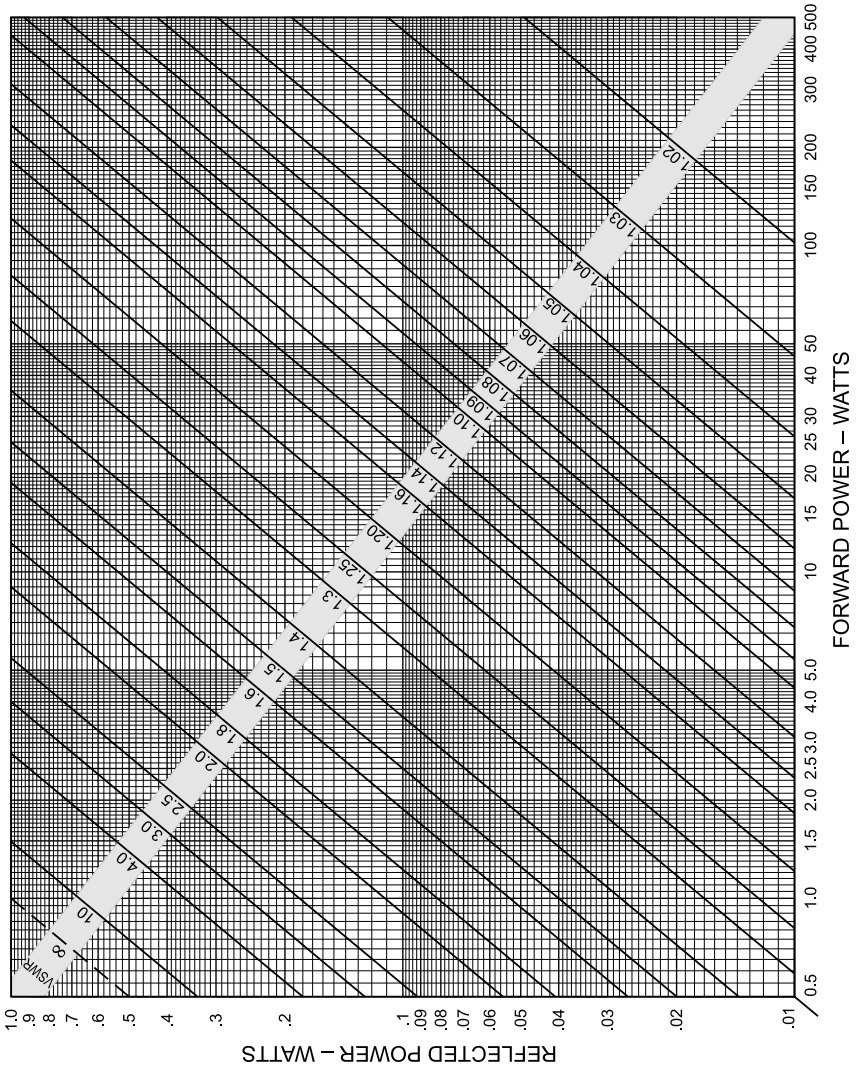

Figure 9 VSWR Conversion Graph (Reflected Power 0.01 – 1.00)



Load Matching

When a Bird APM-16 is used to tune a load to a transmitter and a good match is obtained, removing it will not change the match quality. A good 50 ohm load can terminate a 50 ohm transmission line of any length without altering conditions at the transmitter. The wattmeter is just an additional length of 50 ohm line in series with the measurement.

When the load is not well matched, e.g. an antenna with a VSWR of 1.5 or 2.0, the line length between the load and the transmitter will transform the load impedance as seen at the transmitter. Removing the wattmeter shortens the total line length by four inches plus two connectors. This is still not significant at low frequencies where four to five inches is a small fraction of a wavelength, but at higher frequencies the frequency or power output of the transmitter may be affected.

Transmission line theory shows that if the line length changes by exactly $\frac{1}{2}$ wavelength, the impedance at the transmitter is unchanged. To have identical match quality with the Bird APM-16 in or out of the circuit, it is necessary to insert or remove $\frac{1}{2}$ wavelength worth of line (including the wattmeter). To do this, use a length of cable which, when added to the wattmeter, equals a $\frac{1}{2}$ wavelength at the frequency of interest. If more than one frequency is involved, a separate cable length is required for each. See [Figure 10](#) for sample cable lengths.

Note: *Cable length shown (in inches) is measured from end to end of the outer conductor of the connectors, except for UHF or mini-UHF plugs where the cable length is measured from tip to tip of the center pins.*

Note: *Dimensions shown are for solid polyethylene cable like RG-58C/U or RG-8/U, which have a velocity of propagation 66% of that of air. If RG-58 or RG-8 type cables containing foam polyethylene (velocity of propagation of 79%) are used, the dimensions in the graph must be multiplied by the ratio of the relative velocities; $79\% \div 66\% = 1.2$ in this case.*

Figure 10 Cable Length / Wavelength Matching

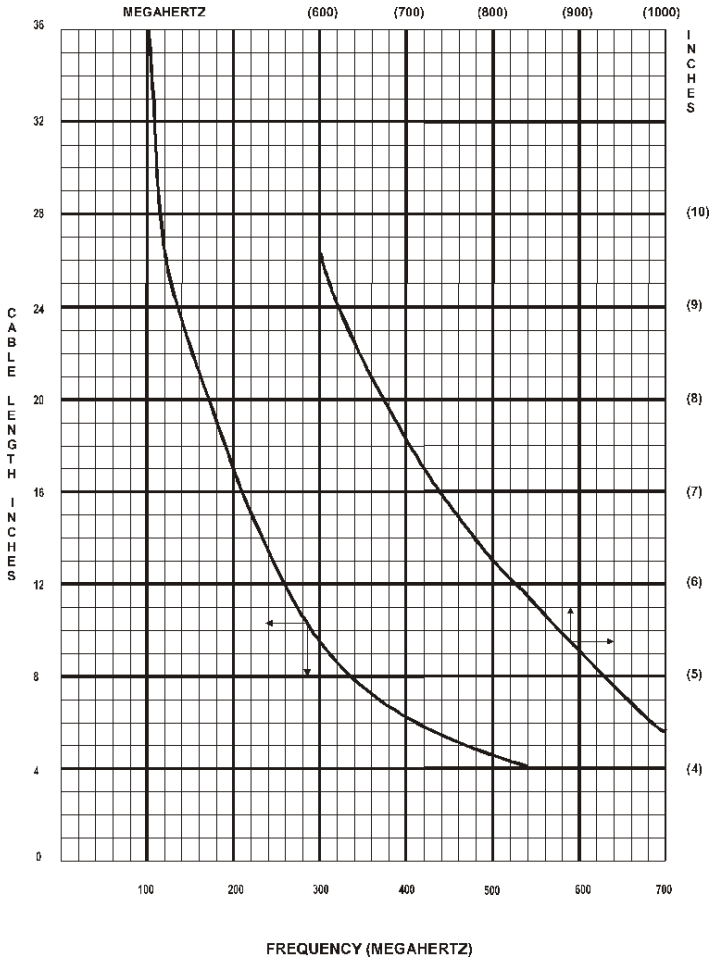

The rugged and simple design of the Bird APM-16 means that it requires minimal routine maintenance.

Troubleshooting

The following table contains troubleshooting information for problems that can occur during normal operation. Find the problem on the table, review possible causes, and perform the corrective action listed.

This manual does not list all malfunctions that may occur, or all corrective actions. If a malfunction is not listed or not corrected by the listed actions, contact the nearest Bird Service Center for assistance.

Problem	Possible Cause	Corrective Action
No meter reading	No RF power	Check RF source
	"Arrow" on element pointing wrong way	Rotate element
	Battery drained	Check the battery and replace if necessary
	DC contact bent	Adjust contact (See " Contact Adjustment " on page 19)
	Open or short circuit in meter leads	Replace defective leads
	Meter burned out or damaged	Return wattmeter for service
Intermittent or inconsistent meter readings	Dirty DC contact on element	Clean contact (See " Cleaning " on page 19)
	Faulty transmission line or antenna	Inspect line
	Sticky or defective meter	Return wattmeter for service
High VSWR or reflected power	Foreign material in line section or in RF connectors	Clean connectors (See " Cleaning " on page 19)
	Open or shorted transmission line	Inspect line
	Bad load or poor connectors	Inspect load, antenna, and connectors

Maintenance Procedures

Cleaning

It is important to keep the following surfaces clean:

- Socket bore
- DC contacts on the element
- Teflon insulators

If any of the contacts or line connectors are dirty, clean them with a cotton swab dipped in commercial contact cleaner or isopropyl alcohol.

CAUTION

Do not attempt to remove the RF center conductor. This will damage the line section.
--

If the RF line section seems dirty, do not loosen any connections. Clean accessible components as described above and use dry, clean air to blow out the interior.

The outside of the meter housing can be cleaned with a soft cloth dampened with a mild detergent solution. Do not wipe the meter glass with a dry cloth, or a static charge could develop that would cause an erroneous meter indication.

Contact Adjustment

When cleaning the socket bore, do not disturb the spring finger of the DC contact. If necessary, the contact can be adjusted manually. The button must be out far enough to maintain good contact, but not so far as to interfere with easy entry of the element body.

Battery

The accuracy of the unit may be reduced by a weak battery. To check the condition of the battery, set the power switch to BAT. If the pointer does not swing into the BATTERY TEST region, replace the battery.

Zero Adjust

The meter's zero setting should be checked when no RF power is present. When no power is applied the pointer should rest exactly on zero. If adjustment is required, set the power switch to OFF and turn the zero screw until the pointer is set at zero (See [Figure 1 on page 1](#) for screw location).

Repair

“QC” Connectors

The Bird 43 is normally supplied with Quick-Change Female N type connectors. Other Bird “QC” connectors are available (See ["Available “QC” Type Connectors" on page 26](#)). To change a QC connector, remove the 8-32 screw at each corner of the connector and then pull it straight outward. Reverse this to install the new connector.

Replacing the Meter

1. Remove the back cover.
2. On the back of the meter, loosen both nuts securing the meter leads and remove the leads.
3. Remove the large Phillips screws securing the meter shock ring.

Note: *These screws are on either side of the housing, even with the meter.*

4. Pull the meter straight out.

Note: *If necessary, the meter retaining ring and shock mount can be removed.*

5. Replace the meter by reversing the steps above.

Replacing the Instrumentation Module

Note: *The instrumentation module contains the line section and circuit board chassis.*

1. Remove the back cover.
2. Use a 0.050" hex wrench, turning clockwise, to loosen the set screw in the power switch knob.
3. Pull the knob straight off.
4. Unsolder the leads on the top of the circuit board chassis.

Note: *Note the color coding when unsoldering so the leads can be returned to their original positions.*

5. Remove the phillips screws on the front of the unit, on either side of the element socket.
6. Pull the instrumentation module straight out.
7. Install a replacement module by reversing the steps above.

Calibration

Calibration of the Bird APM-16 will be required after replacing the meter or the instrumentation module, and also when the calibration certification expires.

Note: *Calibrating the unit, or disturbing the calibration label, within the one-year warranty period will void the warranty.*

Calibration Environment

For best results, make sure that the workspace meets the following requirements:

- The workspace should be free from electrical noise and radiated signals.
- The workspace and equipment should be at a uniform and stabilized temperature, between 20 and 25°C (68 to 77°F).
- The relative humidity should be less than 50% and noncondensing.

Equipment Required

To calibrate the Bird APM-16, you will need the following equipment:

- Standard digital multimeter with DC voltmeter resolution of 0.01 V or better (Fluke Model 87)
- Bird 4401A200 plug-in calibration element
- Regulated DC power supply, supplying 2 ± 0.1 V
- 50 ohm coaxial cables (RG-58-U), no more than 3 feet (1 m) long
- BNC “T” adapter

Figure 11 Calibration Setup

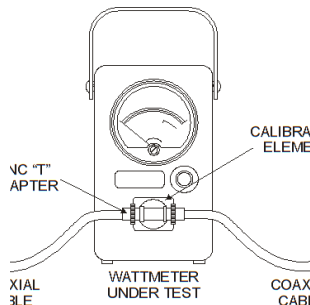

Calibrating

1. Remove any dust plug or element from the APM.
2. Allow the APM and all equipment to stabilize with respect to the workspace environment.

Note: *The APM and the calibration element may require up to 24 hours for complete stabilization if brought from an extreme storage environment.*

3. Set the APM to OFF.
4. Turn the zero screw until the pointer rests at zero (See [Figure 1 on page 1](#) for screw location).
5. Switching between BAT and OFF, rezero until a repeatable zero is obtained.
6. Pierce the label inside the circle with an “X” in it (See [Figure 1 on page 1](#) to locate the hole).

Note: *The calibration access hole is covered by a label showing the calibration date.*

Note: *Disturbing the calibration label within the one-year warranty period will void the warranty.*

7. Connect the power supply, voltmeter, and calibration element as shown in [Figure 11](#) above.

Note: *The APM does not need to be connected at this time.*

8. Turn on the voltmeter and power supply.
9. Set the output to 2.00 ± 0.1 V. Allow the equipment to stabilize for the time recommended by the manufacturer, but for no less than five minutes.
10. Set the APM to ON and allow it a minimum of five minutes to stabilize.
11. After the equipment has stabilized, check the battery in the wattmeter by momentarily setting the power switch to BAT.
12. If the pointer does not swing into the BATTERY TEST region, replace the battery, set the switch back to ON, and allow the APM to stabilize for another five minutes before continuing.
13. Insert the calibration element into the wattmeter.
14. Rotate it in either direction until it stops, then rotate it back 90° to short circuit the contact to the line section body.
15. Rotate the calibration element in either direction until it stops.
16. Adjust the calibration potentiometer (through the calibration access hole) until the pointer rests at “25” on the upper scale.

Storage

CAUTION

To prevent damage from battery leakage, remove the battery if the unit will not be used for more than two weeks.

When storing the meter, keep an element or dust plug in the element socket to prevent the intrusion of dust and to prevent damage to the meter movement. Be sure the power switch is OFF. In any other position, there is a slight drain on the battery.

Customer Service

Any maintenance or service procedure beyond the scope of those in this chapter should be referred to a qualified service center.

If the unit needs to be returned for any reason, request an Return Material Authorization (RMA) through the Bird Technologies website. All instruments returned must be shipped prepaid and to the attention of the RMA number.

Bird Service Center

30303 Aurora Road
Cleveland (Solon), Ohio 44139-2794
Fax: (440) 248-5426
E-mail: bsc@birdrf.com

For the location of the Sales Office nearest you, visit our Web site at:

<http://www.birdrf.com>

Specifications

Frequency Range (Element Dependent)	2 MHz – 2.3 GHz
Power Range (Element Dependent)	1 W – 1 kW
Impedance, Nominal	50 ohms
VSWR, Insertion	1.05:1 max 2 MHz – 1 GHz
Accuracy 10° to 35°C –20° to +50°C	± 4% of reading ± 1% of full scale ± 6% of reading ± 2% of full scale
Peak/Average Ratio	> 10 dB
Settling Time	< 1 s
Meter	Shock mounted linear scale with expanded scales of 25, 50 and 100 full scale. Includes 5% overrange.
Connectors	Bird “QC” N Female normally supplied
Battery	Standard 9V battery. 200 hours operation, minimum.
Operating Position	Any
EMC	Complies with 89/336/EEC and 92/31/EEC
Emissions Immunity Safety	EN 55011:1991 Class B EN 50082-2:1995 EN 61010-1:1993 in accordance with 79/23/EEC and 93/68/EEC Complies with IEC-1010-1, UL-1244, and CSA-231
Temperature, Operating	–4 to +122 °F (–20 to +50 °C)
Temperature, Storage	–13 to +149 °F (–25 to +65 °C)
Humidity	90% noncondensing max
Dimensions (Nominal)	3-5/8”L x 4”W x 6-7/8”H (92 x 102 x 175 mm)
Weight (Approx.)	4 lb. (1.8 kg) with N-Connectors
Finish	Black Powder Coat

Replacement Parts List

Description	Qty.	Part Number
Housing Assembly	1	4401A002
Cover Assembly	1	4401A011
Line Section & Instrumentation Module	1	4401A003
Carrying Strap (Included in Housing Assembly)	1	8580A003
Dust Plug, Aluminum	1	3610-031
Selector Switch Knob	1	4401A014
Meter, DC	1	2080A070
Battery	1	5-1375
RF Connectors	2	See list below

Available “QC” Type Connectors

Connector	Part Number
BNC-Female	4240-125
BNC-Male	4240-132
C-Female	4240-100
C-Male	4240-110
HN-Female	4240-268
HN-Male	4240-278
LC-Female	4240-031
LC-Male	4240-025
LT-Female	4240-018
LT-Male	4240-012
Mini UHF-Female	4240-346
N-Female	4240-062
N-Male	4240-063
Open Term. # 10-32 Nut	4240-363
SC-Female	4240-090
SMA-Female	4240-336
SMA-Male	4240-334
TNC-Female	4240-156
TNC-Male	4240-160
UHF-Female	4240-050
UHF-Male	4240-179
7/16" IEC (Jack) Type 169-4	4240-344
7/16" IEC (Plug) Type 169-4	4240-080
7/8" EIA	4240-002
1-5/8" EIA Fixed	4240-096
1-5/8" EIA Swivel	4240-208

Limited Warranty

All products manufactured by Seller are warranted to be free from defects in material and workmanship for a period of one (1) year, unless otherwise specified, from date of shipment and to conform to applicable specifications, drawings, blueprints and/or samples. Seller's sole obligation under these warranties shall be to issue credit, repair or replace any item or part thereof which is proved to be other than as warranted; no allowance shall be made for any labor charges of Buyer for replacement of parts, adjustment or repairs, or any other work, unless such charges are authorized in advance by Seller.

If Seller's products are claimed to be defective in material or workmanship or not to conform to specifications, drawings, blueprints and/or samples, Seller shall, upon prompt notice thereof, either examine the products where they are located or issue shipping instructions for return to Seller (transportation-charges prepaid by Buyer). In the event any of our products are proved to be other than as warranted, transportation costs (cheapest way) to and from Seller's plant, will be borne by Seller and reimbursement or credit will be made for amounts so expended by Buyer. Every such claim for breach of these warranties shall be deemed to be waived by Buyer unless made in writing within ten (10) days from the date of discovery of the defect.

The above warranties shall not extend to any products or parts thereof which have been subjected to any misuse or neglect, damaged by accident, rendered defective by reason of improper installation or by the performance of repairs or alterations outside of our plant, and shall not apply to any goods or parts thereof furnished by Buyer or acquired from others at Buyer's request and/or to Buyer's specifications. Routine (regularly required) calibration is not covered under this limited warranty. In addition, Seller's warranties do not extend to the failure of tubes, transistors, fuses and batteries, or to other equipment and parts manufactured by others except to the extent of the original manufacturer's warranty to Seller.

The obligations under the foregoing warranties are limited to the precise terms thereof. These warranties provide exclusive remedies, expressly in lieu of all other remedies including claims for special or consequential damages. SELLER NEITHER MAKES NOR ASSUMES ANY OTHER WARRANTY WHATSOEVER, WHETHER EXPRESS, STATUTORY, OR IMPLIED, INCLUDING WARRANTIES OF MERCHANTABILITY AND FITNESS, AND NO PERSON IS AUTHORIZED TO ASSUME FOR SELLER ANY OBLIGATION OR LIABILITY NOT STRICTLY IN ACCORDANCE WITH THE FOREGOING.