

FLUKE®

28 II Ex

True-rms Digital Multimeter

Users Manual

November 2011 Rev. 1, 10/17

© 2011-2017 Fluke Corporation. All rights reserved. Specifications are subject to change without notice.
All product names are trademarks of their respective companies.

LIMITED WARRANTY AND LIMITATION OF LIABILITY

This Fluke product will be free from defects in material and workmanship for three years from the date of purchase. This warranty does not cover fuses, disposable batteries, or damage from accident, neglect, misuse, alteration, contamination, or abnormal conditions of operation or handling. Resellers are not authorized to extend any other warranty on Fluke's behalf. To obtain service during the warranty period, contact your nearest Fluke authorized service center to obtain return authorization information, then send the product to that Service Center with a description of the problem.

THIS WARRANTY IS YOUR ONLY REMEDY. NO OTHER WARRANTIES, SUCH AS FITNESS FOR A PARTICULAR PURPOSE, ARE EXPRESSED OR IMPLIED. FLUKE IS NOT LIABLE FOR ANY SPECIAL, INDIRECT, INCIDENTAL OR CONSEQUENTIAL DAMAGES OR LOSSES, ARISING FROM ANY CAUSE OR THEORY. Since some states or countries do not allow the exclusion or limitation of an implied warranty or of incidental or consequential damages, this limitation of liability may not apply to you.

Fluke Corporation
P.O. Box 9090
Everett, WA 98206-9090
U.S.A.

Fluke Europe B.V.
P.O. Box 1186
5602 BD Eindhoven
The Netherlands

ООО «Флюк СИАЙЭС»
125167, г. Москва,
Ленинградский проспект дом 37,
корпус 9, подъезд 4, 1 этаж

Table of Contents

Title	Page
Introduction	1
How to Contact Fluke	1
Safety Information	2
Ex Safety Information	2
Errors and Load Restrictions	6
Features	8
Automatic Power-Off	14
Input Alert™ Feature	14
Power-Up Options	15
How to Make Measurements	16
AC and DC Voltage Measurements	16
Zero Input Behavior of True-rms Meters	17
Low-Pass Filter	18
Temperature Measurements	19
Continuity Tests	19

Resistance Measurements	21
How to Use Conductance for High Resistance or Leakage Tests	23
Capacitance Measurements	24
Diode Tests.....	25
AC or DC Current Measurements	27
Frequency Measurements	30
Duty Cycle Measurements	32
How to Determine Pulse Width	33
HiRes Mode	33
MIN MAX Recording Mode	34
Smooth Feature (Power Up Option Only)	34
AutoHOLD Mode	36
Relative Mode.....	36
Maintenance	37
General Maintenance.....	37
Fuse Test.....	37
How to Replace the Batteries.....	38
How to Replace the Fuses	41
Service and Parts	41
General Specifications.....	44
Detailed Specifications	46
AC Voltage.....	46
DC Voltage, Conductance, and Resistance	47
Temperature	48
AC Current	48
DC Current.....	49
Capacitance	49
Diode	50
Frequency.....	50

Frequency Counter Sensitivity and Trigger Levels	50
Duty Cycle (Vdc and mVdc)	51
Input Characteristics	51
MIN MAX Recording	52

Introduction

⚠⚠ Warning

Read “Safety Information” before using the Product.

The 28 II Ex Digital Multimeter (the Product) is a compact easy to operate measurement tool for electrical and electronic circuits.

Read the entire *Users Manual* and the *Safety Instructions* before you use the Product.

How to Contact Fluke

To contact Fluke, call one of the following telephone numbers:

- Technical Support USA: 1-800-44-FLUKE (1-800-443-5853)
- Calibration/Repair USA: 1-888-99-FLUKE (1-888-993-5853)
- Canada: 1-800-36-FLUKE (1-800-363-5853)
- Europe: +31 402-675-200
- Japan: +81-3-6714-3114
- China: 86-400-921-0835
- Singapore: +65-6799-5566
- Anywhere in the world: +1-425-446-5500

Or, visit Fluke's website at www.fluke.com.

To register your product, visit <http://register.fluke.com>.

To see, print, or download the latest manual supplement, visit <http://us.fluke.com/usen/support/manuals>.

Safety Information

A **Warning** identifies conditions and procedures that are dangerous to the user. A **Caution** identifies conditions and procedures that can cause damage to the Product or the equipment under test.

Symbols used on the Product and in this manual are explained in Table 1.

To ensure safe operation of the Product, obey all instructions and warnings contained in this manual.

Ex Safety Information

Note

Go to www.ecom-ex.com or www.fluke.com to download the EU Declaration of Conformity and Ex certificate for this product. You can also order a copy from Fluke.

This manual contains information and safety regulations that must be followed for safe, reliable operation of the Product in hazardous areas under the described conditions. Failure to follow the information and instructions can have dangerous consequences, or may contravene applicable legislation.

Read this manual before you use the Product.

If there is a question (because of translation and/or printing errors), refer to the English manual.

⚠⚠ Warning

To prevent electric shock or personal injury while in Ex-HAZARDOUS areas, follow these guidelines:

- Do not open the Product while in an Ex-hazardous area.
- Change the Product's batteries only outside Ex-hazardous areas.
- Do not take spare batteries into Ex-hazardous areas.
- Use only type-approved batteries in the Product. See item 5.1 in the *Safety Information* for a list of approved batteries.
- Do not replace fuses while in an Ex-hazardous area.
- Use only fuses approved for Ex-hazardous areas in this Product. See item 5.3 in the *Safety Information* for a list of approved fuses.
- Use the Product only when the specified connection values are met.
- After you use the Product on a non-i.s. protected circuit, wait 3 minutes before you take the Product into an Ex-hazardous area.

- The Product must be completely and securely fitted in the red holster while it is in an Ex-hazardous area.
- Use only approved accessories with this Product in Ex-hazardous areas.
- Do not use the Product in aggressive acidic or alkaline solutions. For applications requiring Group I equipment, avoid permanent contact of the Product with oil, hydraulic fluid, or grease.
- Do not use the Product in zones 0, 20, 21, or 22. Measurements on intrinsically safe connections that go into these zones are permitted, if the connection values are met.

⚠⚠ Warning

To prevent personal injury in mining hazardous areas:

- Avoid extreme mechanical burdens. The Product can withstand impacts with an energy of seven joules at -20 °C.
- Do not allow the Product to come in permanent contact with oil, hydraulic fluid, or grease.
- Do not install the Product in a fixed installation.

⚠⚠ Warning

To prevent possible electrical shock, fire, or personal injury in ALL areas of operation:

- Read all Safety Information before you use the Product.
- Comply with local and national safety codes. Use personal protective equipment (approved rubber gloves, face protection, and flame-resistant clothes) to prevent shock and arc blast injury where hazardous live conductors are exposed
- See the *Ex Safety Information* section for additional warnings on Product used in hazardous areas.
- Use the Product only as specified, or the protection supplied by the Product can be compromised.

- Do not use the Product in damp or wet environments.
- Do not exceed the Measurement Category (CAT) rating of the lowest rated individual component of a Product, probe, or accessory.
- Examine the case before you use the Product. Look for cracks or missing plastic. Carefully look at the insulation around the terminals.
- Do not use test leads if they are damaged. Examine the test leads for damaged insulation, exposed metal, or if the wear indicator shows. Check test lead continuity.
- Do not work alone.
- Do not touch voltages >30 V ac rms, 42 V ac peak, or 60 V dc.
- Use only correct measurement category (CAT), voltage, and amperage rated probes, test leads, and adapters for the measurement.
- Remove all probes, test leads, and accessories that are not necessary for the measurement.
- Keep fingers behind the finger guards on the probes.
- Limit operation to the specified measurement category, voltage, or amperage ratings.

- **Measure a known voltage first to make sure the Product operates correctly.**
- **Measure for hazardous voltage without the Low-Pass Filter.**
- **Do not apply more than the rated voltage, between the terminals or between each terminal and earth ground.**
- **Do not touch the probes to a voltage source when the test leads are connected to the current terminals.**
- **Connect the common test lead before the live test lead and remove the live test lead before the common test lead.**
- **Replace the batteries when the low battery indicator shows to prevent incorrect measurements.**
- **The battery door must be closed and locked before you operate the Product.**
- **Do not use the Product if it operates incorrectly.**
- **Do not use and disable the Product if it is damaged.**

⚠ Caution

To prevent possible damage to the Product or to the equipment under test, follow these guidelines:

- **Disconnect circuit power and discharge all high-voltage capacitors before testing resistance, continuity, diodes, or capacitance.**
- **Use the proper terminals, function, and range for all measurements.**
- **Before measuring current, check the fuses in the Product. (See *Fuse Test*.)**



















Errors and Load Restrictions

If there is a question that the safety or integrity of this Product is compromised, remove it from operation and the Ex-hazardous areas immediately. Also, do whatever is necessary to prevent Product operation by others until the Product is examined by an ecom certified technician. It is recommended that you send the Product to the manufacturer to be examined.

Because the safety and reliability of the Product can be at risk, do not operate the Product if:

- Visible damage is found in the housing of the Product.
- The Product has had an excessive load put on it for which it is not designed.
- The Product was not stored correctly.
- The Product has sustained damage in transit.
- Illegible inscriptions or lettering shows on the Product.
- A Product malfunction occurs.
- Obvious measurement inaccuracies occur.
- Measurements/simulations are no longer possible with the Product.
- Permitted tolerances or threshold values were exceeded.

Table 1. Symbols

	WARNING - RISK OF DANGER. Consult user documentation.		WARNING. HAZARDOUS VOLTAGE. Risk of electric shock.
	Double Insulated		Capacitance
	AC (Alternating Current)		Diode
	DC (Direct Current)		Conforms to European Union directives.
	Earth		Conforms to relevant South Korean EMC Standards.
	Fuse		Conforms to the European Explosive Atmospheres (ATEX) directive.
	Battery. Low battery when displayed.		Certified by CSA Group to North American safety standards.
	Continuity test or continuity beeper tone.		Certified by TÜV SÜD Product Service.
	Conforms to relevant Australian Safety and EMC standards.		
CAT II	Measurement Category II is applicable to test and measuring circuits connected directly to utilization points (socket outlets and similar points) of the low-voltage MAINS installation.		
CAT III	Measurement Category III is applicable to test and measuring circuits connected to the distribution part of the building's low-voltage MAINS installation.		
CAT IV	Measurement Category IV is applicable to test and measuring circuits connected at the source of the building's low-voltage MAINS installation.		
	This product complies with the WEEE Directive marking requirements. The affixed label indicates that you must not discard this electrical/electronic product in domestic household waste. Product Category: With reference to the equipment types in the WEEE Directive Annex I, this product is classed as category 9 "Monitoring and Control Instrumentation" product. Do not dispose of this product as unsorted municipal waste.		

Features

Tables 2 through 5 show the features of the Product.

Table 2. Inputs

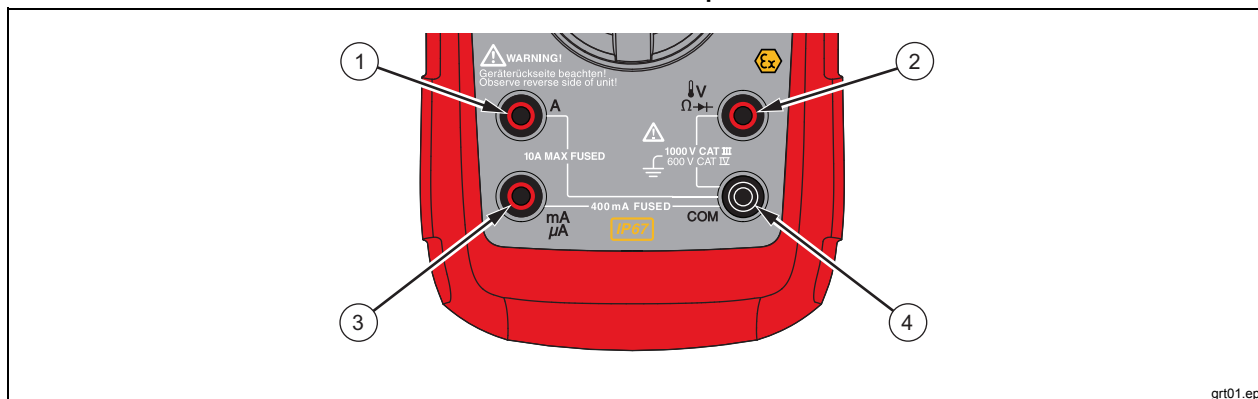

grt01.eps

Item	Terminal	Description
①	A	Input for 0 A to 10.00 A current (10 A to 20 A overload for 30 seconds maximum), current frequency, and duty cycle measurements.
②	$\downarrow V$ $\Omega \rightarrow$	Input for voltage, continuity, resistance, diode, capacitance, frequency, temperature, and duty cycle measurements.
③	mA μA	Input for 0 μA to 400 mA current measurements (600 mA for 18 hrs) and current frequency and duty cycle.
④	COM	Return terminal for all measurements.

Table 3. Rotary Switch Positions













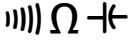

Switch Position	Function
Any Position	When the Product is turned on, the Product model number briefly shows on the display.
	AC voltage measurement Push  (yellow) for low-pass filter ()
	DC voltage measurement
	600 mV dc voltage range Push  (yellow) for temperature ()
	Push  for continuity test. Ω Resistance measurement Push  (yellow) for capacitance measurement.
	Diode test
	AC current measurements from 0 mA to 10.00 A Push  (yellow) for dc current measurements, from 0 mA to 10.00 A.
	AC current measurements from 0 μ A to 6000 μ A Push  (yellow) for dc current measurements from 0 μ A to 6000 μ A.

Table 4. Pushbuttons



















Button	Switch Position	Function
 (Yellow)	    	<p>Set to capacitance</p> <p>Set to temperature</p> <p>Turn on ac low-pass filter</p> <p>Set dc or ac current</p> <p>Set dc or ac current</p>
	Any position 	<p>Change and set the range for the set function. To go to autoranging, hold the button down for 1 second.</p> <p>Sets to °C or °F.</p>
	Any position MIN MAX recording Frequency counter	<p>AutoHOLD (formerly TouchHold) captures the current measurement on the display. When a new, stable measurement is sensed, the Product beeps and shows the new measurement.</p> <p>Stops and starts recording. Does not erase recorded values.</p> <p>Stops and starts the frequency counter.</p>

Table 4. Pushbuttons (cont.)

Button	Switch Position	Function
	Continuity  Ω  MIN MAX recording Hz, Duty Cycle	Toggle the continuity beeper on and off. Switches between Peak (250 μ s) and Normal (100 ms) response times. Toggles the Product to trigger on positive or negative slope.
	Any position	Turns on the button backlight and display backlight, makes them brighter, and turns off the backlights. Hold  down for 1 second to enter the HiRes digit mode. The “HiRes” icon shows in the display. To go back to the 3-1/2 digit mode, hold  down for 1 second. HiRes=19.999.
	Any position	Starts recording of minimum and maximum values. Steps the display through MAX, MIN, AVG (average), and current measurement. Cancels MIN MAX (hold for 1 second).
 (Relative mode)	Any position	Stores the current measurement as a reference for subsequent measurements. The display is zeroed, and the stored measurement is subtracted from all subsequent measurements.
	Any position except diode test	Push  for frequency measurements. Push again to go to duty cycle mode.



grt09.eps

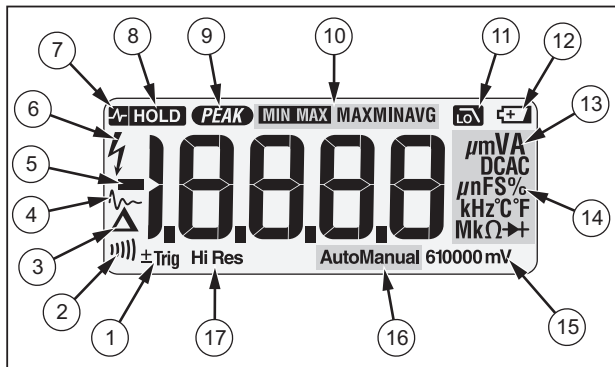

Figure 1. Display Features

Table 5. Display Features

Number	Feature	Indication
①	\pm Trig	Positive or negative slope indicator for Hz/duty cycle triggering.
②		The continuity beeper is on.
③		Relative (REL) mode is active.
④		Smoothing is active.



Number	Feature	Indication
⑤	-	Negative measurement. In relative mode, this sign shows that the input is less than the stored reference.
⑥		High voltage present at the input. Appears if the input voltage is 30 V or greater (ac or dc). Also shows in low-pass filter mode. Also shows in cal, Hz, and duty cycle modes.
⑦		AutoHOLD is active.
⑧		Display HOLD is active.
⑨		Peak Min Max modes and the response time is 250 μ s.
⑩		Minimum-maximum recording mode.
⑪		Low-pass filter mode. See "Low-pass Filter".

Table 5. Display Features (cont.)

Number	Feature	Indication
⑫		Low battery. ⚠️⚠️ Warning: To avoid false readings, which could lead to possible electric shock or personal injury, replace the battery as soon as the battery indicator appears.
⑬	A, μ A, mA	amperes (amps), microamp, milliamp
	V, mV	volts, millivolts
	μ F, nF	microfarad, nanofarad
	nS	nanosiemens
	%	Percent. Used for duty cycle measurements.
	Ω , M Ω , k Ω	ohm, megohm, kilohm
	Hz, kHz	hertz, kilohertz
		Diode test mode
AC DC	Alternating current, direct current	

Number	Feature	Indication
⑭	$^{\circ}$ C $^{\circ}$ F	Degrees Celsius, Degrees Fahrenheit
⑮	610000 mV	Displays selected range
⑯	Auto	Autorange mode. Automatically selects the range with the best resolution.
	Manual	Manual range mode
⑰	HiRes	High resolution (Hi Res) mode HiRes=19,999

Table 5. Display Features (cont.)

Number	Feature	Indication
--		Overload condition is detected.
Error Messages		
bAt t		Replace the battery immediately.
d, Sc		In the capacitance function, too much electrical charge is on the capacitor under test.
Cal Err		Invalid calibration data. Calibrate Product.
EEPROM Err		Invalid EEPROM data. Have the Product serviced.
Open		Open thermocouple detected.
F2-		Invalid model. Have the Product serviced.
LEAD		 Test lead alert. Shows when the test leads are in the A or mA/μA terminal and the selected rotary switch position does not correspond to the terminal being used.

Automatic Power-Off

The Product automatically turns off if you do not turn the rotary switch or push a button for 30 minutes. If MIN MAX Recording mode is on, the Product will not turn off. Refer to Table 6 to disable automatic power-off.

Input Alert™ Feature

If a test lead is connected to the mA/μA or A terminal, but the rotary switch is not set to the correct current position, the beeper warns you by making a chirping sound and the display flashes "LEAD". This warning is intended to stop you from attempting to measure voltage, continuity, resistance, capacitance, or diode values with the leads plugged into a current terminal.













Caution

To prevent damage, do not put the probes across (in parallel with) a circuit with power with a lead connected to a current terminal. This can cause damage to a circuit with power and blow the Product fuse. This can occur because the resistance through the current terminals of the Product is very low and causes a short circuit.

Power-Up Options

To set a power-up option, push a button from the list in Table 6 as you turn on the Product.

Table 6. Power-Up Options

Button	Power-Up Option
 (Yellow)	Disables automatic power-off feature (Product normally powers off in 30 minutes). The Product reads "PoFF" until  is released.
	Sets the Product in calibration mode and prompts for a password. The Product shows "CAL" in the display and enters calibration mode. See 28 II Ex Calibration Information.
	Turns on the smoothing feature. The Product reads "S--" until  is released.
	Turns on all LCD segments.
	Disables the beeper for all functions. The Product reads "bEEP" until  is released.
	Disables auto backlight off (backlight normally disables after 2 minutes). The Product reads "LoFF" until  is released.
	Sets the Product into the high impedance mode when the mV dc function is used. The Product reads "Hi Z" until  is released.

How to Make Measurements

The Product features true-rms measurements, which are accurate for distorted sine waves and other waveforms (with no dc offset) such as square waves, triangle waves, and staircase waves.

AC and DC Voltage Measurements

The voltage ranges of the Product are 600.0 mV, 6.000 V, 60.00 V, 600.0 V, and 1000 V. To select the 600.0 mV dc range, turn the rotary switch to $\overline{\text{mV}}$.

Refer to Figure 2 to measure ac or dc voltage.

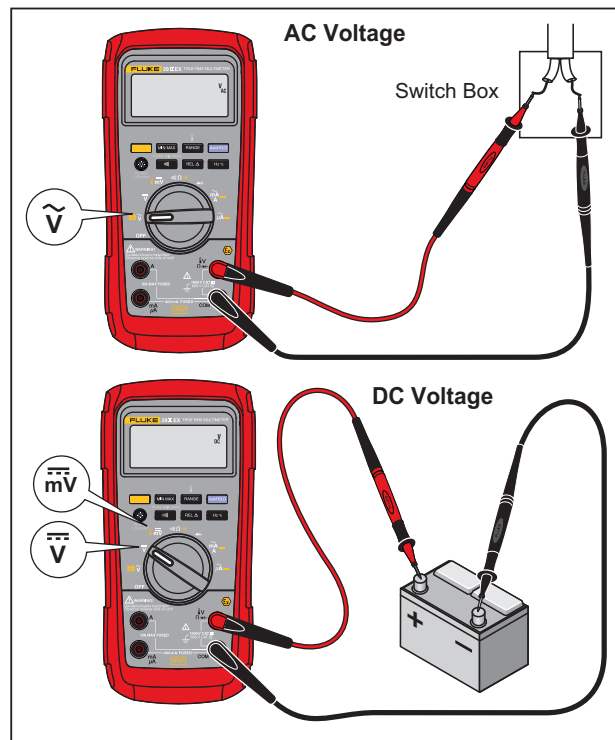

grt02.eps

Figure 2. AC and DC Voltage Measurements

When you measure voltage, the Product puts approximately 10-M Ω (10,000,000 Ω) impedance in parallel with the circuit. This loading effect can cause measurement errors in high-impedance circuits. In most cases, the error is negligible (0.1 % or less) if the circuit impedance is 10 k Ω (10,000 Ω) or less.

For better accuracy when you measure the dc offset of an ac voltage, measure the ac voltage first. Record the ac voltage range, then manually select a dc voltage range equal to or higher than the ac range. This procedure has better accuracy of the dc measurement because the input protection circuits are disabled.



Zero Input Behavior of True-rms Meters

True-rms meters accurately measure distorted waveforms, but when the input leads are shorted together in the ac functions, the Product shows a measurement between 1 and 30 counts. When the test leads are open, the measurements can change from interference. These offset measurements are common. They do not change the ac measurement accuracy of the Product for the specified measurement ranges.

Unspecified input levels are:

- AC voltage: below 3 % of 600 mV ac, or 18 mV ac
- AC current: below 3 % of 60 mA ac, or 1.8 mA ac
- AC current: below 3 % of 600 μ A ac, or 18 μ A ac

Low-Pass Filter

The Product has an ac low-pass filter. When you measure ac voltage or ac frequency, push  to set the low-pass filter mode (). The Product measures in the chosen mode, but the signal diverts through a filter that stops unwanted voltages more than 1 kHz, refer to Figure 3. The lower frequency voltages go through with decreased accuracy to the measurement less than 1 kHz. The low-pass filter can get you better measurement performance on composite sine waves that are typically found on inverters and variable-frequency motor drives.

Warning

To prevent electric shock or personal injury, do not use the low-pass filter when you measure for hazardous voltages. Voltages larger than what is shown can be present. First, make a voltage measurement without the filter to see if a hazardous voltage is present. Then, select the filter.

Note

When the low-pass filter is selected, the Product goes to manual range mode. Push  to set the range. The Product does not autorange with the low-pass filter set.

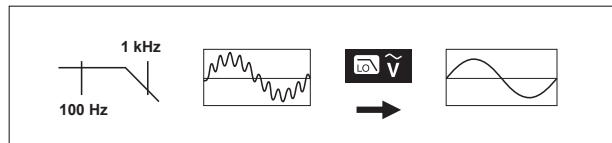

aom11f.eps

Figure 3. Low-Pass Filter

Temperature Measurements

The Product measures the temperature of a type-K thermocouple (included). Push **RANGE** to toggle between degrees Celsius (°C) or degrees Fahrenheit (°F).

Caution

To prevent damage to the Product or other equipment, remember that while the Product is rated for -200.0 °C to +1090.0 °C (-328.0 °F to 1994 °F), the included type-K thermocouple is rated to 260 °C. For temperatures out of that range, use a higher rated thermocouple.

Display ranges are -200.0 °C to +1090 °C and -328.0 °F to 1994 °F. Measurements outside these ranges show ∞ in the display. When there is no thermocouple connected, the display also shows ∞ .

To measure temperature:

1. Connect a type-K thermocouple to the COM and $\frac{\downarrow}{\Omega \rightarrow}$ terminals of the Product.
2. Turn the rotary switch to $\frac{\downarrow}{mV}$.
3. Push **□** to enter temperature mode.
4. Push **RANGE** to choose Celsius or Fahrenheit.

Continuity Tests

Caution

To prevent damage to the Product or to the equipment under test, disconnect circuit power and discharge all high-voltage capacitors before you do a continuity test.

The continuity test has a beeper that sounds when a circuit is complete. You can do continuity tests and not have to look at the display.

To do a continuity test, set up the Product as shown in Figure 4.

Push **** to turn on or turn off the continuity beeper.

The continuity function senses intermittent opens and shorts that last as little as 1 ms. A brief short causes the Product to emit a short beep.

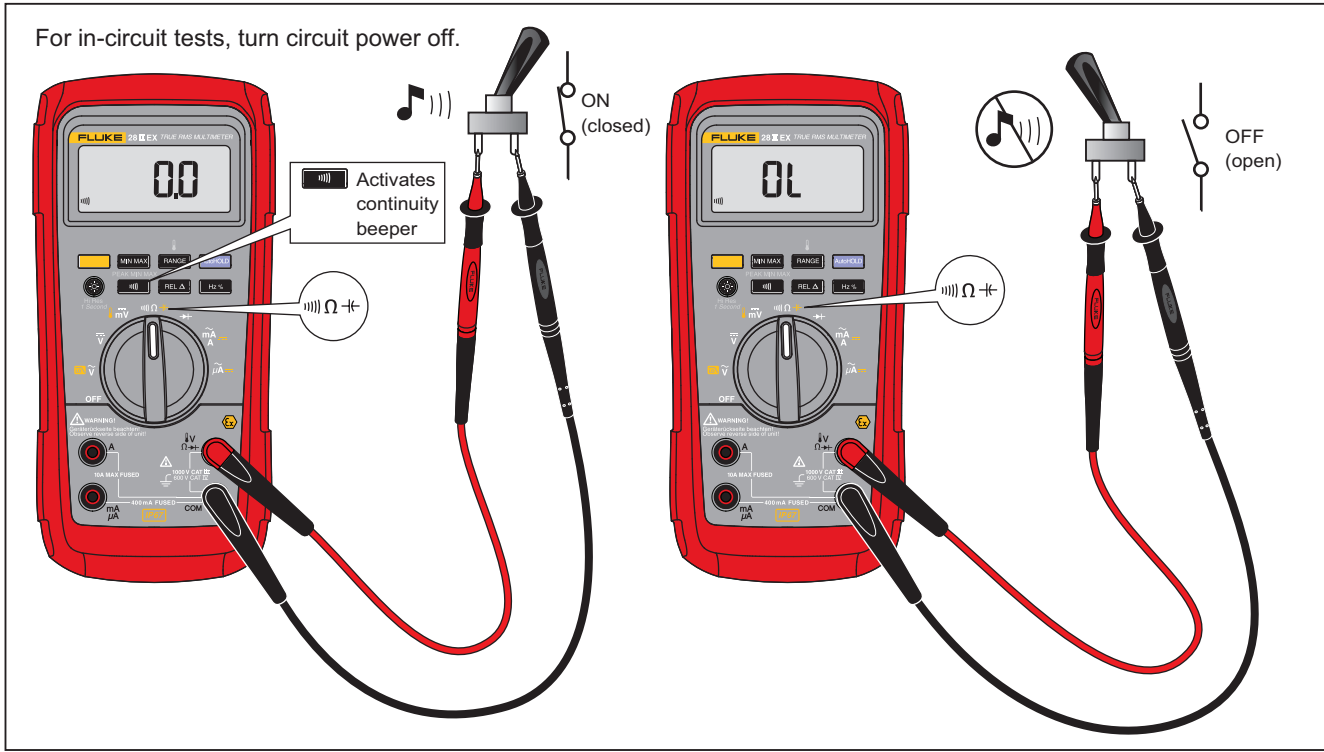

grt03.eps

Figure 4. Continuity Tests

Resistance Measurements

⚠ Caution

To prevent damage to the Product or to the equipment under test, disconnect the power and discharge all high-voltage capacitors before you measure resistance.

The Product sends a small current through the circuit to measure resistance. Because this current flows through all possible paths between the probes, the resistance measurement shows the total resistance of all paths between the probes.

The resistance ranges of the Product are 600.0 Ω , 6.000 k Ω , 60.00 k Ω , 600.0 k Ω , 6.000 M Ω , and 50.00 M Ω .

Connect the Product to the circuit as shown in Figure 5 to measure resistance.

Some guidelines for resistance measurements are:

- The measured value of a resistor in a circuit can be different from the resistor's rated value.
- The test leads can add 0.1 Ω to 0.2 Ω of error to resistance measurements. To test the leads, touch the probe tips together and read the resistance of the leads. If necessary, you can use the relative (REL) mode to automatically subtract this value.
- The resistance function can output a voltage that causes a forward-bias silicon diode or transistor junction to conduct. If this occurs, push **RANGE** to apply a lower current in the next higher range. If the value is higher, use the higher value. Refer to the Input Characteristics table in the specifications section for typical short-circuit currents.

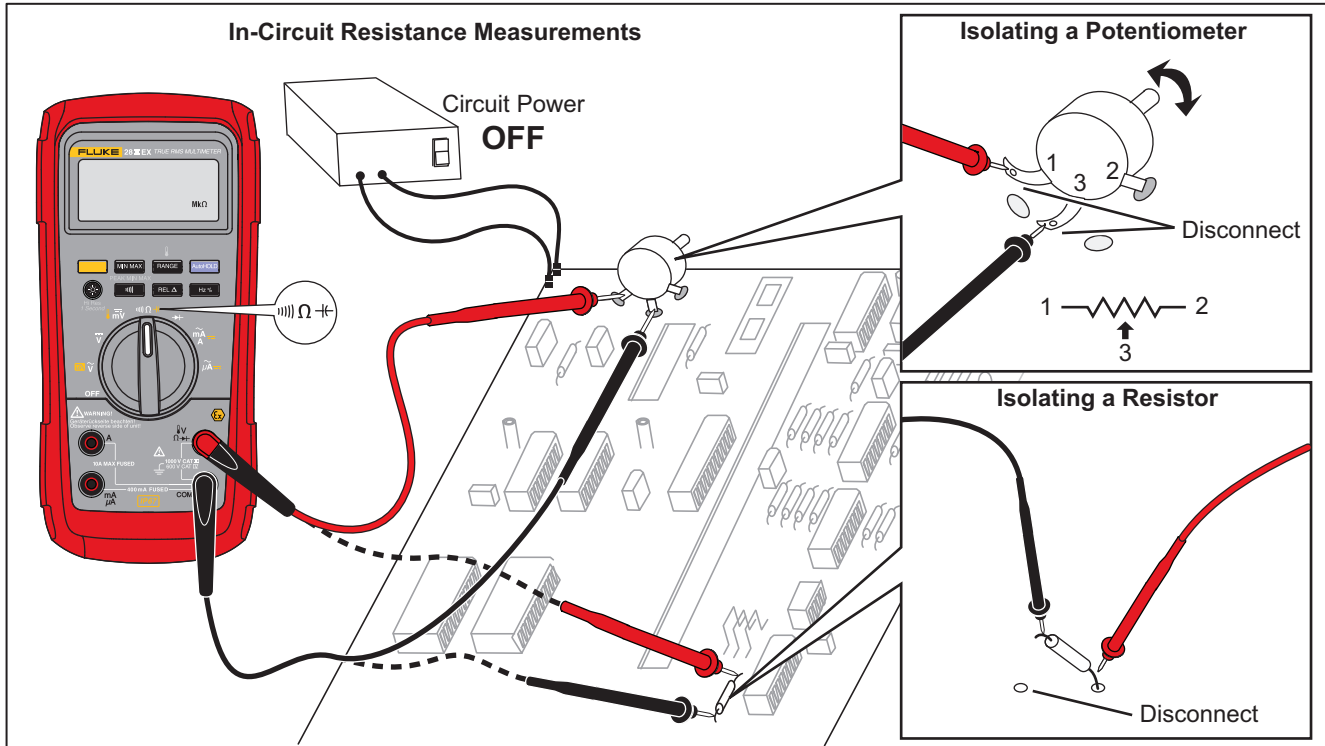

Figure 5. Resistance Measurements

grt04.eps

How to Use Conductance for High Resistance or Leakage Tests

Conductance, the inverse of resistance, is a measure of how easily current goes through a circuit. High values of conductance are the same as low values of resistance.

The 60-nS range of the Product measures conductance in nanosiemens (1 nS = 0.000000001 siemens). Because such small quantities of conductance are equal to very high resistance, the nS range lets you measure the resistance of components with a maximum of 100,000 M Ω , 1/1 nS = 1,000 M Ω .

To measure conductance, set up the Product for resistance measurement as shown in Figure 5, then push **RANGE** until the nS indicator shows in the display.

Some guidelines for conductance measurements are:

- High-resistance measurements are susceptible to electrical noise. To smooth out most noisy measurements, start the MIN MAX recording mode; then step to the average (AVG) reading.
- It is usual to have a conductance measurement in the display with the test leads open. To make sure you make accurate measurements, use the relative (REL) mode to subtract this open measurement value.

Capacitance Measurements

⚠ Caution

To prevent damage to the Product or to the equipment under test, disconnect circuit power and discharge all high-voltage capacitors before you measure capacitance. Use the dc voltage function to make sure that the capacitor is discharged.

The capacitance ranges of the Product are 10.00 nF, 100.0 nF, 1.000 μ F, 10.00 μ F, 100.0 μ F, and 9999 μ F.

To measure capacitance, set up the Product as shown in Figure 6.

For the best capacitance measurement accuracy on capacitance less than 1000 nF, use the relative (REL) mode to subtract the remaining capacitance of the Product and leads.

Note

When a capacitor under test has too much electrical charge, the display shows “diSC”.

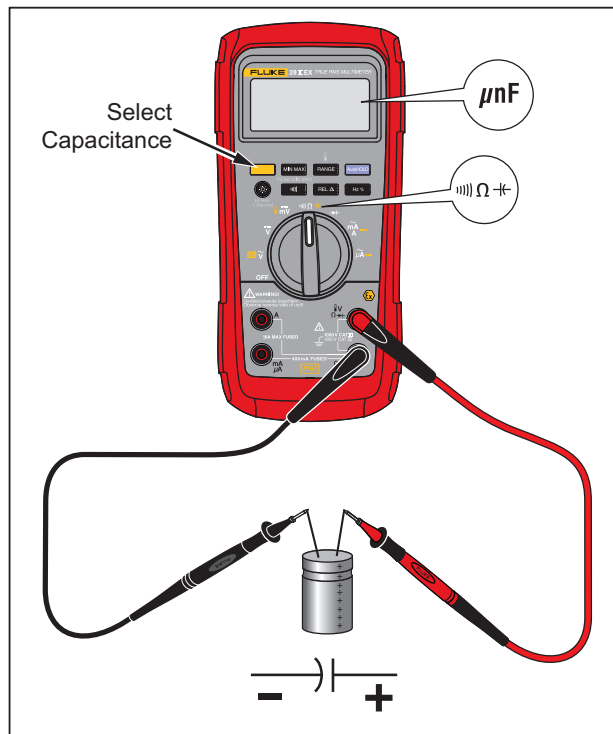

grt05.eps

Figure 6. Capacitance Measurements

Diode Tests

⚠ Caution

To prevent damage to the Product or to the equipment under test, disconnect circuit power and discharge all high-voltage capacitors before you do a diode test.

Use the diode test to examine diodes, transistors, silicon controlled rectifiers (SCRs), and other semiconductor devices. This test sends current through a semiconductor junction, while it measures the junction's voltage drop. A good silicon junction drops between 0.5 V and 0.8 V.

To do an out-of-circuit diode test, set up the Product as shown in Figure 7. For forward-bias measurements on a semiconductor component, put the red test lead on the component's positive terminal and put the black lead on the component's negative terminal.

In a circuit, a good diode will cause a forward-bias measurement of 0.5 V to 0.8 V. A reverse-bias measurement can be different because of the resistance of other pathways between the probe tips.

A short beep sounds if the diode is good (<0.85 V). A continuous beep sounds if the measurement is ≤ 0.100 V. This measurement shows a short circuit. The display shows "OL" if the diode is open.

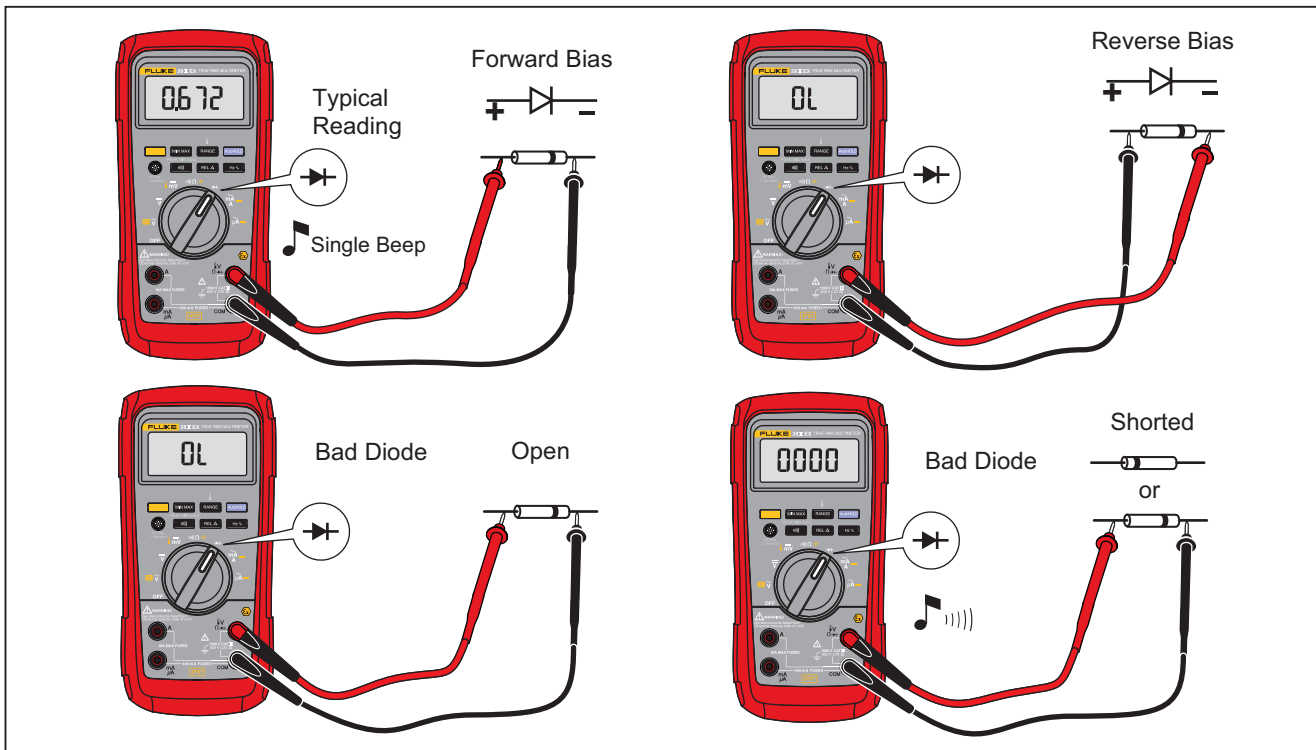

Figure 7. Diode Tests

grt06.eps

AC or DC Current Measurements

⚠⚠ Warning

To prevent electric shock or personal injury, do not try an in-circuit current measurement where the open-circuit potential to earth is larger than 1000 V. You can cause Product damage or personal injury if the fuse blows.

⚠ Caution

To prevent damage to the Product or to the equipment under test:

- **Examine the fuses of the Product before you measure current.**
- **Use the correct terminals, function, and range for all measurements.**
- **Do not put the probes across (in parallel with) a circuit or component when the leads are connected to the current terminals.**

To measure current, you must open the current path of the circuit under test and put the Product in series with the circuit.

The current ranges of the Product are 600.0 μA , 6000 μA , 60.00 mA, 400.0 mA, 6.000 A, and 10.00 A.

To measure current, refer to Figure 8 and continue as follows:

1. Remove power from the circuit. Discharge all high-voltage capacitors.
2. Put the black lead into the **COM** terminal. For currents between 0 mA and 400 mA, put the red lead into the **mA/ μA** terminal. For currents more than 400 mA, put the red lead into the **A** terminal.

Note

To prevent damage to the 400-mA fuse of the Product, use the mA/ μA terminal only if you are sure the current is less than 400 mA continuously or less than 600 mA for 18 hours or less.

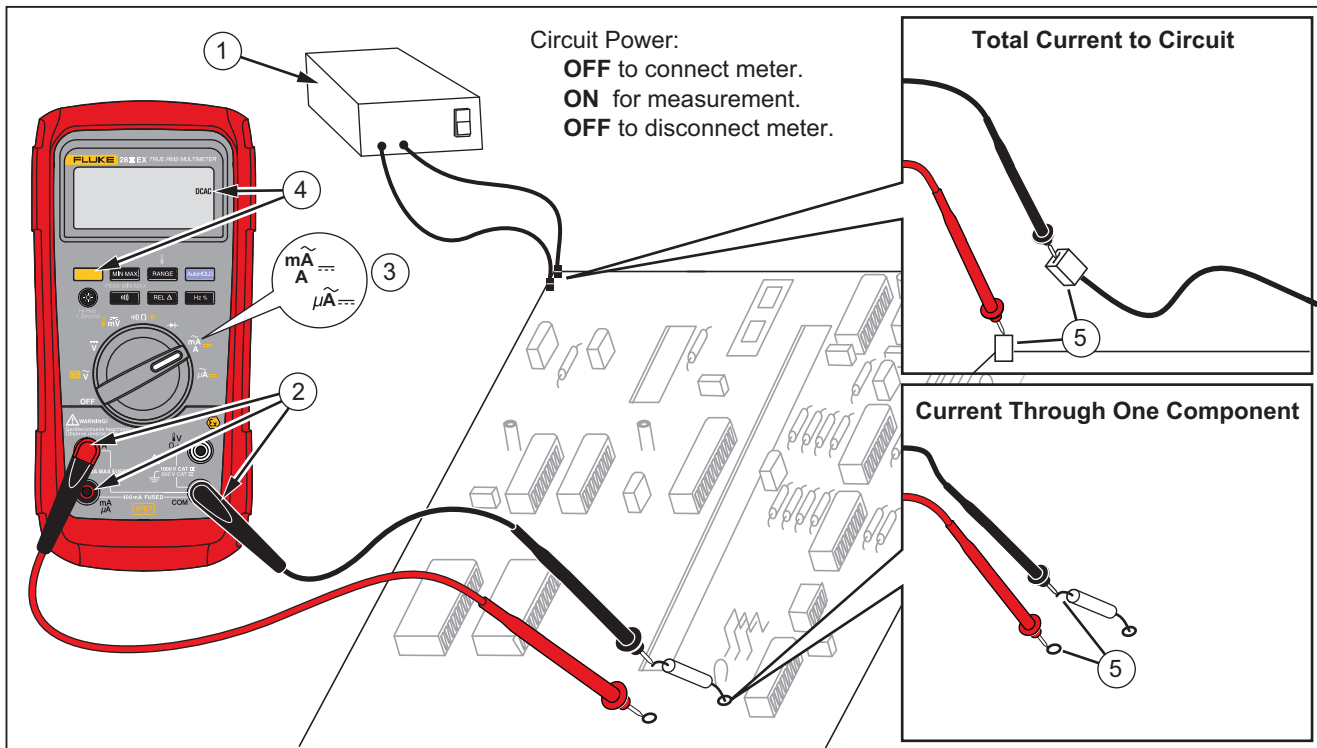

Figure 8. Current Measurements

grt07.eps

3. If you use the **A** terminal, set the rotary switch to mA/A. If you use the **mA/μA** terminal, set the rotary switch to $\mu\tilde{A}$ for currents below 6000 μA (6 mA), or \tilde{mA} for currents above 6000 μA .
4. To measure dc current, push .
5. Open the test circuit path. Touch the black probe to the more negative side of the break. Touch the red probe to the more positive side of the break. If the leads are reversed, the measurement will be negative, but will not cause Product damage.
6. Apply power to the circuit and then read the display. Be sure to note the unit given at the right side of the display (μA , mA, or A).
7. Remove power from the circuit and discharge all high-voltage capacitors. Remove the Product and restore the circuit to normal operation.

Some guidelines for current measurements are:

- If the current measurement is 0 A and you are sure the Product is set up correctly, do a fuse test. See the "Fuse Test" section.
- A current meter drops a small voltage across itself, which could change circuit operation. You can calculate this burden voltage with the values shown in the specifications.

Frequency Measurements

For frequency measurements, the Product counts the number of times the signal crosses a set voltage level each second.

Table 7 summarizes the trigger levels and applications for frequency measurements in the ranges of the voltage and current functions of the Product.

To measure frequency, connect the Product to the signal source. Next, push **Hz %**. When you push **|||**, the trigger slope switches between + and -, as shown by the symbol at the left side of the display (refer to Figure 9 under "Duty Cycle"). Push **AutoHOLD** to stop and start the counter.

The Product autoranges to one of five frequency ranges: 199.99 Hz, 1999.9 Hz, 19.999 kHz, 199.99 kHz, and >200 kHz. For frequencies less than 10 Hz, the display is updated at the frequency of the input. Less than 0.5 Hz, the display can be unstable.

Some guidelines for frequency measurements are:

- If a measurement shows as 0 Hz or is unstable, the input signal can be below or near the trigger level. To correct these problems, go to a lower range, which increases the sensitivity of the Product. In the \bar{V} function, the lower ranges also have lower trigger levels.
- If a measurement is a multiple of what you expect, the input signal can be distorted. Distortion can cause multiple triggers of the frequency counter. Select a higher voltage range to decrease Product sensitivity and try to repair this problem. You can also set a dc range to increase the trigger level as a possible solution. In general, the lowest frequency shown in the display is the correct one.

Table 7. Functions and Trigger Levels for Frequency Measurements

Function	Range	Approximate Trigger Level	Typical Application
\tilde{V}	6 V, 60 V, 600 V, 1000 V	±5 % of scale	Most signals.
\tilde{V}	600 mV	±30 mV	High-frequency 5 V logic signals. (The dc-coupling of the \tilde{V} function can attenuate high-frequency logic signals, reducing their amplitude enough to interfere with triggering.)
\overline{mV}	600 mV	40 mV	Refer to the measurement guidelines given before this table.
\overline{V}	6 V	1.7 V	5 V logic signals (TTL).
\overline{V}	60 V	4 V	Automotive switching signals.
\overline{V}	600 V	40 V	Refer to the measurement guidelines given before this table.
\overline{V}	1000 V	100 V	
$\downarrow \uparrow$ $\Omega \rightarrow$	Frequency counter characteristics are not available or specified for these functions.		
$A\sim$	All ranges	±5 % of scale	AC current signals.
$\mu A\overline{---}$	600 μA , 6000 μA	30 μA , 300 μA	Refer to the measurement guidelines given before this table.
$mA\overline{---}$	60 mA, 400 mA	3.0 mA , 30 mA	
$A\overline{---}$	6 A, 10 A	0.30 A, 3.0 A	

Duty Cycle Measurements

Duty cycle (or duty factor) is the percentage of time a signal is above or below a trigger level in one cycle (Figure 9). The duty cycle mode is optimized to measure the on or off time of logic and switching signals. Systems such as electronic fuel injection systems and switching power supplies are controlled by pulses that have different widths, which can be measured by a duty cycle measurement.

To measure duty cycle, set up the Product to measure frequency. Then push **Hz %** a second time. As with the frequency function, push **|||)** to change the slope for the counter.

For 5-V logic signals, use the 6-V dc range. For 12-V switching signals in automobiles, use the 60 V dc range. For sine waves, use the lowest range that does not result in multiple triggers. (Normally, a distortion-free signal can be up to 10x the amplitude of the selected voltage range.)

If a duty cycle measurement is unstable, push MIN MAX and then scroll to the AVG (average) display.

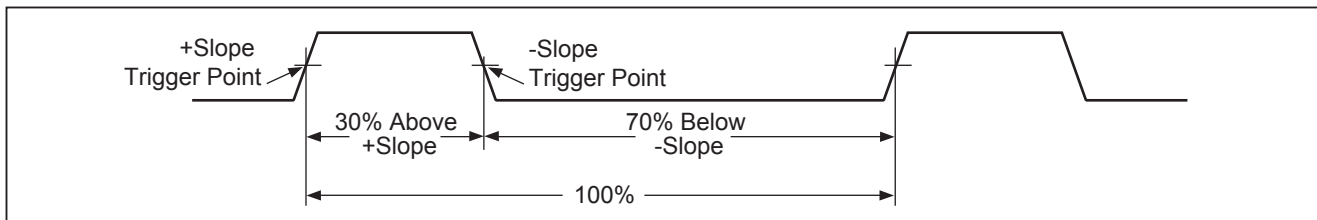

iyf.eps

Figure 9. Components of Duty Cycle Measurements

How to Determine Pulse Width

For a periodic waveform (its pattern repeats at equal time intervals), you can find the time that the signal is high or low as follows:

1. Measure the signal's frequency.
2. Push **Hz %** a second time to measure the signal's duty cycle. Push **||||** to select a measurement of the signal's positive or negative pulse, refer to Figure 9.
3. Use this formula to find the pulse width:

$$\text{Pulse Width (in seconds)} = \frac{\% \text{ Duty Cycle} \div 100}{\text{Frequency}}$$

HiRes Mode

On the Product, push **⊕** for one second to enter the high-resolution (HiRes) 4-1/2 digit mode. Measurements are shown at 10x the usual resolution with a maximum display of 19,999 counts. The HiRes mode works in all modes but capacitance, frequency counter functions, temperature, and the 250 μs (peak) MIN MAX modes.

To go to the 3-1/2 digit mode, push **⊕** for one second.

MIN MAX Recording Mode

The MIN MAX mode records minimum and maximum input values. When the inputs go below the recorded minimum value or above the recorded maximum value, the Product beeps and records the new value. This mode can be used to record intermittent measurements, record maximum measurements while you are away or record measurements while you operate the equipment under test and cannot look at the Product. MIN MAX mode can also calculate an average of all measurements since the MIN MAX mode was started. To use MIN MAX mode, refer to the functions in Table 8.

Response time is the length of time an input must stay at a new value to be recorded. A shorter response time records shorter events, but with decreased accuracy. All recorded measurements are erased when you change the response time. The Product has 100 millisecond and 250 μ s (peak) response times. The 250 μ s response time is indicated by "**PEAK**" on the display.

The 100 millisecond response time is best for power supply surges, inrush currents, and intermittents.

The average value (AVG) shown in the display is the mathematical integral of all measurements since the start of recording (overloads are discarded). The average value is useful to smooth out unstable inputs, calculate power consumption, or to get a percentage of time estimate on how long a circuit is on.

Min Max records the signal extremes that are longer than 100 ms.

Peak records the signal extremes that are longer than 250 μ s.





Smooth Feature (Power Up Option Only)

When the input signal changes quickly, "smoothing" gives a more stable measurement on the display.

To use the smooth feature:

1. Hold down **RANGE** while you turn the Product on. The display shows "5---" until **RANGE** is released.
2. The Smoothing icon (\sim) will appear on the left side of the display to let you know that smoothing is on.

Table 8. MIN MAX Functions

Button	MIN MAX Function
	Enter MIN MAX recording mode. The Product is locked in the range shown before you started MIN MAX mode. (Set the measurement function and range before you enter MIN MAX.) The Product beeps each time a new minimum or maximum value is recorded.
 (while in MIN MAX mode)	Step through maximum (MAX), minimum (MIN), average (AVG) and current values.
 PEAK MIN MAX	Select 100 ms or 250 μ s response time. (The 250 μ s response time is shown by PEAK on the display.) Stored values are erased. The current and AVG (average) values are not available when 250 μ s is selected.
	Stop recording. Stored values are not erased. Push again to continue recording.
 (hold for 1 second)	Exit MIN MAX mode. Stored values are erased. The Product stays in the selected range.



AutoHOLD Mode

Warning

To prevent electrical shock or personal injury, do not use AutoHOLD mode to see if circuits are without power. The AutoHOLD mode will not hold on unstable or noisy measurements.

The AutoHOLD mode locks the current measurement on the display. When a new, stable measurement is sensed, the Product beeps and shows the new measurement. To start or exit AutoHOLD mode, push .

Relative Mode

When you set relative mode () , the Product zeros the display and stores the current measurement as the reference for subsequent measurements. The Product is locked into the range selected when you push  . Push  again to exit this mode.

In relative mode, the measurement shown is always the difference between the current measurement and the stored reference value. For example, if the stored reference value is 15.00 V and the current measurement is 14.10 V, the display shows -0.90 V.

Maintenance

Warning

To prevent electrical shock or personal injury, have the Product repaired by ECOM Instruments GmbH or an ECOM authorized service center to keep Product certification.

General Maintenance

To clean the external surfaces of the Product, wipe the case with a damp cloth and mild detergent. Do not use abrasives or solvents.

Dirt or moisture in the terminals can cause incorrect measurements and can falsely set off the Input Alert feature. Clean the terminals as follows:

1. Turn off the Product and remove all test leads.
2. Shake out dirt that can be in the terminals.
3. Soak a clean swab with mild detergent and water. Move the swab around in each terminal. Dry each terminal with canned air to push the water and detergent out of the terminals.

Fluke recommends calibration for the Product in two-year intervals by Fluke.

Fuse Test

As shown in Figure 10, with the Product in the Ω function, put a test lead into the Ω jack and place the probe tip on the other end of the test lead against the metal of the current input jack. If “LEAd” appears in the display, the probe tip has been inserted too far into the amps input jack. Lift the lead out a bit until the message no longer shows in the display and OL or a resistance measurement shows in the display. The resistance value must be as shown in Figure 10. If the tests give measurements other than those shown, have the Product serviced.

Warning

To prevent electric shock or personal injury, remove the test leads and all input signals before you replace the batteries or fuses. To prevent damage or injury, install ONLY specified replacement fuses with the amperage, voltage, and speed ratings shown in Table 9.

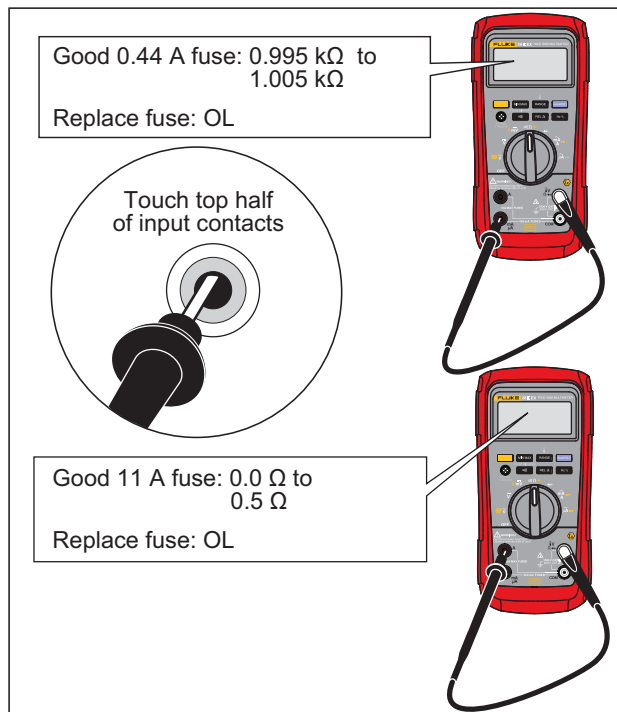

Figure 10. Current Fuse Test

How to Replace the Batteries

Replace the batteries with three AAA batteries (NEDA 24A IEC LR03).

⚠⚠ Warning

To prevent electrical shock or personal injury:

- Replace the batteries when the low battery indicator (🔋) shows to prevent incorrect measurements. If the display shows “batt” the Product will not function until the batteries are replaced.
- Use only three AAA 1.5-volt batteries, correctly installed to power the Product. See item 5.1 in the *Safety Information* for a list of approved batteries. All batteries are to be replaced at the same time with same part number batteries outside the Ex-hazardous area.

Replace the batteries as follows, refer to Figure 11:

1. Turn the rotary switch to OFF and remove the test leads from the terminals.
2. Remove the six Torx-head screws from the case bottom and remove the battery door (①).

Note

When you lift the battery door, make sure the rubber gasket stays attached to the battery compartment barrier.

3. Remove the three batteries and replace all three with AAA Alkaline batteries (②).
4. Make sure the battery compartment gasket (③) is properly installed around the outside edge of the battery compartment barrier.
5. Align the battery compartment barrier with battery compartment while you replace the battery door.
6. Attach the door with the six Torx-head screws.

Note

Fluke recommends that you remove the batteries from the Product for long periods of storage.

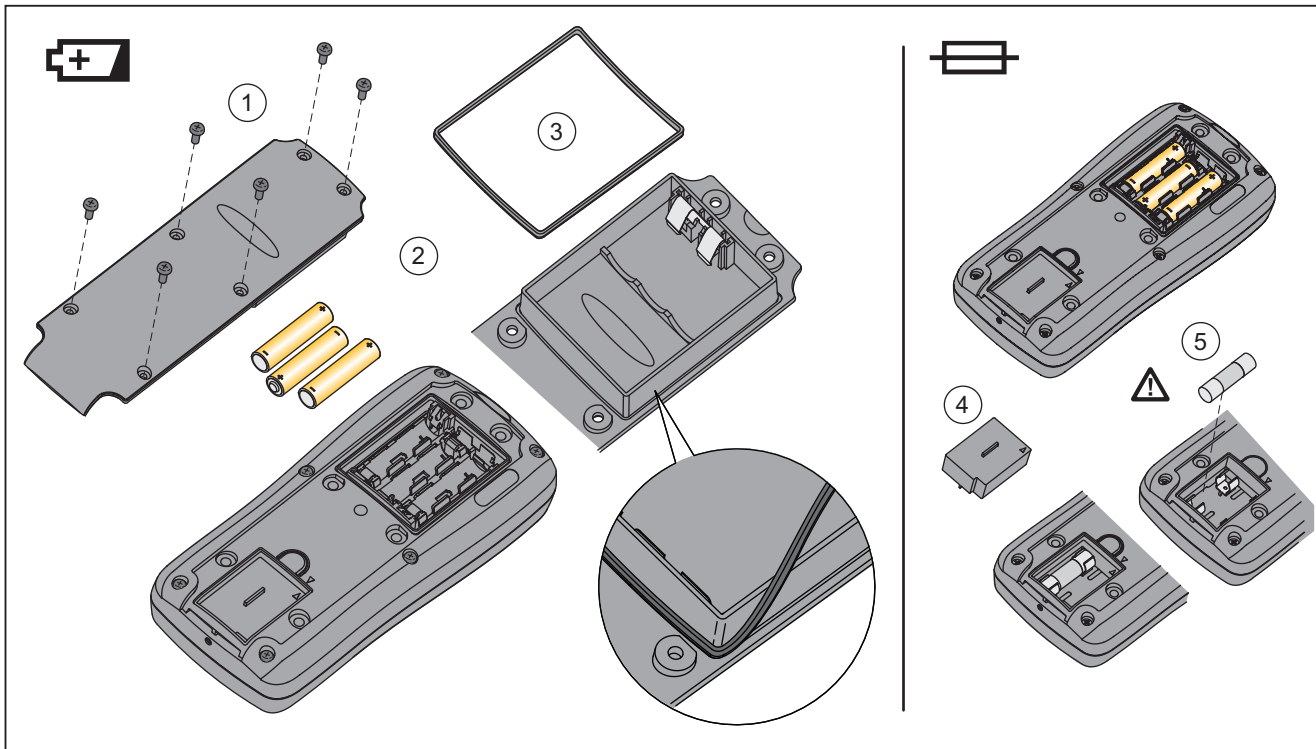

Figure 11. Battery and Fuse Replacement

grt10.eps

How to Replace the Fuses

Examine or replace the fuses in the Product as follows (See Figure 11):

1. Turn the rotary switch to OFF and remove the test leads from the terminals
2. Refer to step 2 in *How to Replace the Batteries* to remove the battery door.
3. Carefully lift out the fuse assembly (④) from the fuse compartment.
4. Remove the 11 A fuse by carefully prying one end loose, then lift the fuse out of its bracket (⑤).
5. Install ONLY specified replacement fuses with the amperage, voltage, and speed ratings shown in Table 9. The 440-mA fuse is attached to the fuse

assembly. You must use a new fuse assembly to replace the 440 mA fuse.

6. Install the fuse assembly into the fuse compartment.
7. Refer to *How to Replace the Batteries* to replace the battery door.

Service and Parts

If the Product fails, examine the batteries and fuses. Refer to this manual to make sure the Product is used correctly.

Replacement parts and accessories are shown in Table 9 and Figure 12.

To order parts and accessories, see *How to Contact Fluke*.

Table 9. Replacement Parts

Description	Qty.	Fluke Part or Model Number
Fuse, 11 A, 1000 V, FAST	1	803293
28 II Ex Fuse Assembly	1	4016494
Alligator Clip, Black	1	AC172 or AC175
Alligator Clip, Red	1	
Test Lead Set	1	TL175
28 II Ex Getting Started Manual	1	3945752
Fluke Input Cap, Amp Jack Plugs for DMMs (10 pack)	1	4145825
⚠ To ensure safety, use exact replacement only.		

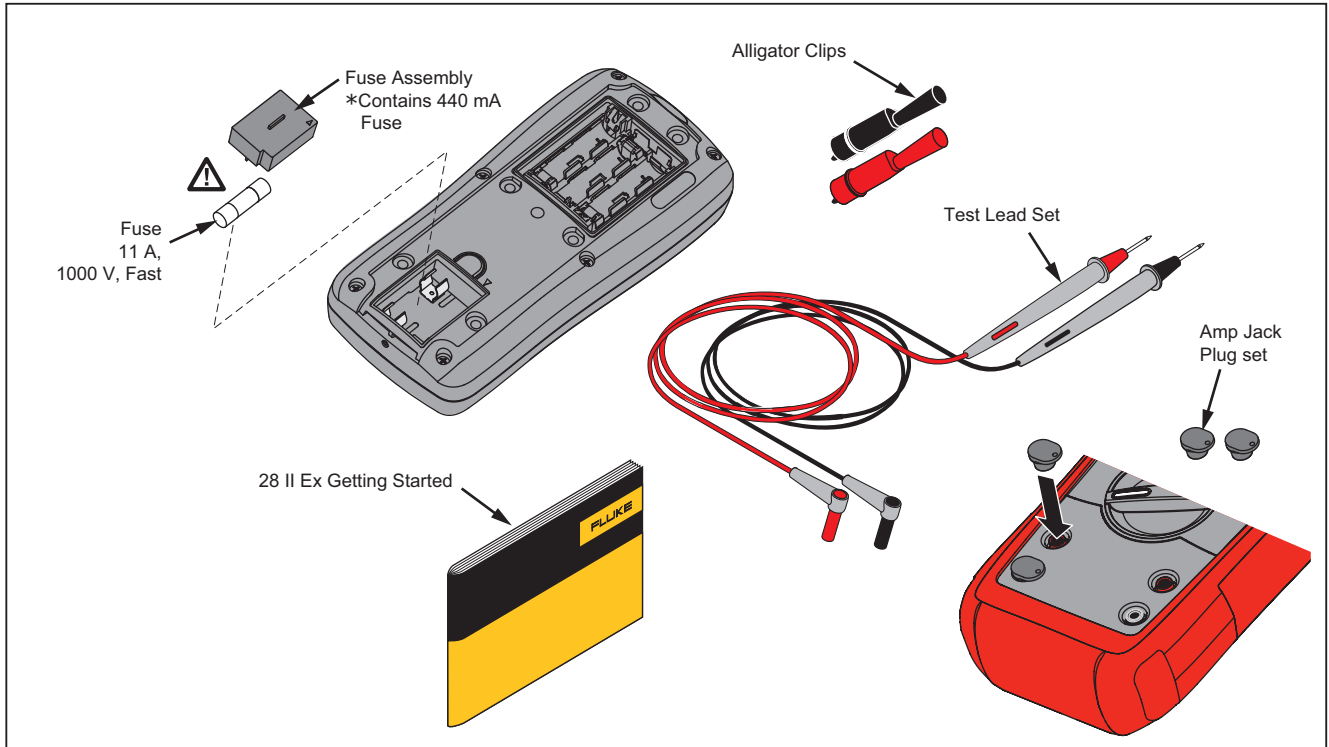

Figure 12. Replacement Parts

grt11.eps

General Specifications

Maximum voltage between any terminal and earth ground	1000 V
⚠ Fuse for mA inputs	0.44 A, 1000 V IR 10 kA
⚠ Fuse for A inputs	11 A, 1000 V IR 17 kA
Display	6000 counts, updates 4/sec (19,999 counts in high-resolution mode).
Altitude	
Operating	2000 meters
Storage	10 000 meters
Operating Temperature	Different temperature ranges for T_{amb} are fixed by type-approved batteries (see separate <i>Safety Instructions</i> for a list of approved batteries)
Temperature coefficient	0.05 X (specified accuracy) / °C (<18 °C or >28 °C)
Relative Humidity	0 % to 80 % (0 °C to 35 °C) 0 % to 70 % (35 °C to 50 °C)
Battery Type	3 AAA Alkaline batteries, NEDA 24A IEC LR03 (see separate <i>Safety Instructions</i> for a list of approved batteries)
Battery Life	400 hr typical without backlight (Alkaline)
Size (H x W x L)	4.57 cm x 10.0 cm x 21.33 cm (1.80 in x 3.95 in x 8.40 in)
Size with Holster	6.35 cm x 10.0 cm x 19.81 cm (2.50 in x 3.95 in x 7.80 in)
Weight	567.8 g (1.25 lb)
Weight with Holster and Flex-Stand	769.8 g (1.70 lb)

Safety

General	IEC 61010-1: Pollution Degree 2
Measurement	IEC 61010-2-033: CAT IV 600V / CAT III 1000V
Ingress Protection	IEC 60529: IP67, non-operating

Electromagnetic Compatibility (EMC) In an RF field of 3 V/M, accuracy = specified accuracy +20 counts, except 600 μ A dc range total accuracy = specified accuracy +60 counts. Temperature not specified

International	IEC 61326-1: Portable Electromagnetic Environment IEC 61326-2-2 CISPR 11: Group 1, Class A
---------------------	---

Group 1: Equipment has intentionally generated and/or uses conductively-coupled radio frequency energy that is necessary for the internal function of the equipment itself.

Class A: Equipment is suitable for use in all establishments other than domestic and those directly connected to a low-voltage power supply network that supplies buildings used for domestic purposes. There may be potential difficulties in ensuring electromagnetic compatibility in other environments due to conducted and radiated disturbances.

Caution: This equipment is not intended for use in residential environments and may not provide adequate protection to radio reception in such environments.

Korea (KCC).....	Class A Equipment (Industrial Broadcasting & Communication Equipment)
------------------	---

Class A: Equipment meets requirements for industrial electromagnetic wave equipment and the seller or user should take notice of it. This equipment is intended for use in business environments and not to be used in homes.

USA (FCC).....	47 CFR 15 subpart B. This product is considered an exempt device per clause 15.103.
----------------	---

Detailed Specifications

For all detailed specifications:

Accuracy is specified for 2 years after calibration, at operating temperatures of 18 °C to 28 °C, with relative humidity at 0 % to 80 %.

Accuracy specifications take the form of \pm ([% of Reading] + [Number of least-significant digits]). In the 4 ½-digit mode, multiply the number of least-significant digits (counts) by 10.

AC Voltage

AC conversions are ac-coupled and valid from 3 % to 100 % of range.

Range	Resolution	Accuracy					
		45 Hz – 65 Hz	30 Hz – 200 Hz	200 Hz – 440 Hz	440 Hz – 1 kHz	1 kHz – 5 kHz	5 kHz – 20 kHz
600.0 mV	0.1 mV	$\pm(0.7 \% + 4)$	$\pm(1.0 \% + 4)$		$\pm(2 \% + 4)$ ^[2]	$\pm(2 \% + 4)$	$\pm(2 \% + 20)$ ^[1]
6.000 V	0.001 V					Unspecified	
60.00 V	0.01 V	Unspecified					
600.0 V	0.1 V	Unspecified					
1000 V	1 V	Unspecified					
Low-Pass Filter		$\pm(0.7 \% + 2)$	$\pm(1.0 \% + 4)$ ^[1]	+1.0 % + 4 -6.0 % - 4 ^[3]	Unspecified	Unspecified	Unspecified
<p>[1] Below 10 % of range, add 12 counts.</p> <p>[2] Frequency range: 1 kHz to 2.5 kHz</p> <p>[3] Specification increases from -1 % to -6 % at 440 Hz when filter is used.</p>							

DC Voltage, Conductance, and Resistance

Function	Range	Resolution	Accuracy
mV dc	600.0 mV	0.1 mV	$\pm(0.1\% + 1)$
V dc	6.000 V	0.001 V	$\pm(0.05\% + 1)$
	60.00 V	0.01 V	
	600.0 V	0.1 V	
	1000 V	1 V	
Ω	600.0 Ω	0.1 Ω	$\pm(0.2\% + 2)$ ^[2]
	6.000 k Ω	0.001 k Ω	$\pm(0.2\% + 1)$
	60.00 k Ω	0.01 k Ω	
	600.0 k Ω	0.1 k Ω	$\pm(0.6\% + 1)$
	6.000 M Ω	0.001 M Ω	
	50.00 M Ω	0.01 M Ω	$\pm(1.0\% + 3)$ ^[1,3]
nS	60.00 nS	0.01 nS	$\pm(1.0\% + 10)$ ^[1,2,3]

[1] Add 0.5 % of reading when measuring above 30 M Ω in the 50 M Ω range, and 20 counts below 33 nS in the 60 nS range.
 [2] When using the rel function to compensate for offsets.
 [3] >40 °C temperature coefficient is 0.1 x (specified accuracy)/°C.

Temperature

Range	Resolution	Accuracy [1,2]
-200 °C to +1090 °C	0.1 °C	±(1.0 % + 10)
-328 °F to +1994 °F	0.1 °F	±(1.0 % + 18)

[1] Does not include error of the thermocouple probe.
 [2] Accuracy specification assumes ambient temperature stable to ± 1 °C. For ambient temperature changes of ± 5 °C, rated accuracy applies after 2 hours.

AC Current

Function	Range	Resolution	Burden Voltage	Accuracy
				(45 Hz – 2 kHz) [1]
µA ac	600.0 µA	0.1 µA	100 µV/µA	±(1.0 % + 2)
	6000 µA	1 µA	100 µV/µA	
mA ac	60.00 mA	0.01 mA	1.8 mV/mA	
	400.0 mA [2]	0.1 mA	1.8 mV/mA	
A ac	6.000 A	0.001 A	0.03 V/A	
	10.00 A [3,4]	0.01 A	0.03 V/A	

[1] AC conversions are ac coupled, true rms responding, and valid from 3 % to 100 % of range, except 400 mA range. (5 % to 100 % of range) and 10 A range (15 % to 100 % or range).
 [2] 400 mA continuous. 600 mA for 18 hr maximum.
 [3]  10 A continuous up to 35 °C. <20 minutes on, 5 minutes off at 35 °C to 55 °C. >10 A to 20 A for 30 seconds maximum, 5 minutes off.
 [4] >10 A accuracy unspecified.

DC Current

Function	Range	Resolution	Burden Voltage	Accuracy
μA dc	600.0 μA	0.1 μA	100 μV/μA	±(0.2 % + 4)
	6000 μA	1 μA	100 μV/μA	±(0.2 % + 2)
mA dc	60.00 mA	0.01 mA	1.8 mV/mA	±(0.2 % + 4)
	400.0 mA ^[1]	0.1 mA	1.8 mV/mA	±(0.2 % + 2)
A dc	6.000 A	0.001 A	0.03 V/A	±(0.2 % + 4)
	10.00 A ^[2,3]	0.01 A	0.03 V/A	±(0.2 % + 2)

[1] 400 mA continuous; 600 mA for 18 hr maximum.
 [2]  10 A continuous up to 35 °C. <20 minutes on, 5 minutes off at 35 °C to 55 °C. >10 A to 20 A for 30 seconds maximum, 5 minutes off.
 [3] >10 A accuracy unspecified.

Capacitance

Range	Resolution	Accuracy
10.00 nF	0.01 nF	±(1.0 % + 2) ^[1]
100.0 nF	0.1 nF	
1.000 μF	0.001 μF	±(1.0 % + 2)
10.00 μF	0.01 μF	
100.0 μF	0.1 μF	
9999 μF	1 μF	

[1] With a film capacitor or better, using the rel mode to zero residual.

Diode

Range	Resolution	Accuracy
2.000 V	0.001 V	$\pm(2.0 \% + 1)$

Frequency

Range	Resolution	Accuracy
199.99 Hz	0.01 Hz	$\pm(0.005 \% + 1)^{[1]}$
1999.9 Hz	0.1 Hz	
19.999 kHz	0.001 kHz	
199.99 kHz	0.01 kHz	
>200 kHz	0.1 kHz	Unspecified

[1] From 0.5 Hz to 200 kHz and for pulse widths > 2 μ s.

Frequency Counter Sensitivity and Trigger Levels

Input Range	Minimum Sensitivity (RMS Sine Wave)		Approximate Trigger Level (DC Voltage Function)
	5 Hz – 20 kHz	0.5 Hz – 200 kHz	
600 mV dc	70 mV (to 400 Hz)	70 mV (to 400 Hz)	40 mV
600 mV ac	150 mV	150 mV	-
6 V	0.3 V	0.7 V	1.7 V
60 V	3 V	7 V (≤ 140 kHz)	4 V
600 V	30 V	70 V (≤ 14.0 kHz)	40 V
1000 V	100 V	200 V (≤ 1.4 kHz)	100 V

Duty Cycle (Vdc and mVdc)

Range	Accuracy
0.0 % to 99.9 % [1]	Within $\pm (0.2 \% \text{ per kHz} + 0.1 \%)$ for rise times $< 1 \mu\text{s}$. [2]
[1] 0.5 Hz to 200 kHz, pulse width $> 2 \mu\text{s}$. Pulse width range is determined by the frequency by the frequency of the signal. [2] For 6 V dc range accuracy is unspecified.	

Input Characteristics

Function	Overload Protection	Input Impedance (nominal)	Common Mode Rejection Ratio (1 k Ω unbalance)		Normal Mode Rejection					
$\overline{\overline{V}}$	1000 V rms	10 M Ω <100 pF	$> 120 \text{ dB}$ at dc, 50 Hz or 60 Hz		$> 60 \text{ dB}$ at 50 Hz or 60 Hz					
$\overline{\overline{mV}}$	1000 V rms									
\tilde{V}	1000 V rms	10 M Ω < 100 pF (ac-coupled)	$> 60 \text{ dB}$, dc to 60 Hz							
		Open Circuit Test Voltage	Full Scale Voltage		Typical Short Circuit Current					
			To 6 M Ω	5 M Ω or 60 nS	600 Ω	6 k Ω	60 k Ω	600 k Ω	6 M Ω	50 M Ω
Ω	1000 V rms	<7.0 V dc	<1.7 V dc	<1.9 V dc	500 μA	100 μA	10 μA	1 μA	0.4 μA	0.2 μA
\rightarrow	1000 V rms	<7.0 V dc	2.200 V dc		1.0 mA typical					

MIN MAX Recording

Nominal Response	Accuracy
100 ms to 80 % (dc functions)	Specified accuracy ± 12 counts for changes > 200 ms in duration
120 ms to 80 % (ac functions)	Specified accuracy ± 40 counts for changes > 350 ms and inputs > 25 % of range
250 μ s (peak) ^[1]	Specified accuracy ± 200 counts for changes > 250 μ s in duration (add ± 100 counts for readings over 6000 counts) (add ± 100 counts for readings in Low Pass mode)
[1] For 6 V range: 1 ms	